

HUMAN HEALTH

ENVIRONMENTAL HEALTH



SOLUTIONS THAT
TAKE YOUR SCIENCE
IN THE RIGHT DIRECTION

2015-2016 Analytical Consumables and Supplies

Atomic Spectroscopy | Chromatography | Materials Characterization



New Investments – Local Support – Proven Quality!

For over 75 years, PerkinElmer has helped our global laboratory partners meet their most demanding application measurement challenges. Our experience in Chromatography, Spectroscopy and Materials Characterization gives us a unique advantage in providing holistic and comprehensive solutions for laboratories in universities and key market segments like Environmental, Energy, and Food & Product Safety.

When you order our precision designed, genuine PerkinElmer consumables and accessories, you can enjoy the peace of mind, ease of ordering, and best in class service. You'll get the results you need – accurately and on time. PerkinElmer selects only the highest quality products for our consumables portfolio and invests heavily to test and validate the quality of our products.

| AFRICA | | | |
|----------------------|---------------------|---------------------|-------------------------|
| Country | Telephone | Facsimile | Email |
| ALGERIA | +213 (0)21 91 63 73 | +213 (0)21 91 63 82 | info@htds.fr |
| ANGOLA | +27 11 564 2400 | +27 11 564 2440 | info.za@perkinelmer.com |
| BENIN | +33 1 64 86 28 28 | +33 1 69 07 69 54 | info@htds.fr |
| BOTSWANA | +27 11 564 2400 | +27 11 564 2440 | info.za@perkinelmer.com |
| BRITISH INDIAN OCEAN | +202 22905306 | +202 22905307 | info@htds.fr |
| BURKINA FASO | +33 1 64 86 28 28 | +33 1 69 07 69 54 | info@htds.fr |
| BURUNDI | +33 1 64 86 28 28 | +33 1 69 07 69 54 | info@htds.fr |
| CAMEROON | +33 1 64 86 28 28 | +33 1 69 07 69 54 | info@htds.fr |
| CAPE VERDE | +33 1 64 86 28 28 | +33 1 69 07 69 54 | info@htds.fr |
| CENTRAL AFRICA REP. | +33 1 64 86 28 28 | +33 1 69 07 69 54 | info@htds.fr |
| CHAD | +33 1 64 86 28 28 | +33 1 69 07 69 54 | info@htds.fr |
| COMOROS | +33 1 64 86 28 28 | +33 1 69 07 69 54 | info@htds.fr |
| CONGO | +33 1 64 86 28 28 | +33 1 69 07 69 54 | info@htds.fr |
| DEMO. REP. CONGO | +33 1 64 86 28 28 | +33 1 69 07 69 54 | info@htds.fr |
| DSCHIBUTI REP. | +33 1 64 86 28 28 | +33 1 69 07 69 54 | info@htds.fr |
| EGYPT | +202 22905306 | +202 22905307 | info@htds.fr |
| EQUATORIAL GUINEA | +33 1 64 86 28 28 | +33 1 69 07 69 54 | info@htds.fr |
| ERITREA | +202 22905306 | +202 22905307 | info@htds.fr |
| ETHIOPIA | +202 22905306 | +202 22905307 | info@htds.fr |
| GABON | +33 1 64 86 28 28 | +33 1 69 07 69 54 | info@htds.fr |
| GAMBIA | +33 1 64 86 28 28 | +33 1 69 07 69 54 | info@htds.fr |
| GHANA | +202 22905306 | +202 22905307 | info@htds.fr |
| GUINEA | +33 1 64 86 28 28 | +33 1 69 07 69 54 | info@htds.fr |
| GUINEA – Bissau | +33 1 64 86 28 28 | +33 1 69 07 69 54 | info@htds.fr |
| IVORY COAST | +33 1 64 86 28 28 | +33 1 69 07 69 54 | info@htds.fr |
| KENYA | +202 22905306 | +202 22905307 | info@htds.fr |
| LESOTHO | +27 11 564 2400 | +27 11 564 2440 | info.za@perkinelmer.com |
| LIBERIA | +202 22905306 | +202 22905307 | info@htds.fr |

ORDERING INFORMATION

| AFRICA | | | |
|--------------------------|----------------------|----------------------|-------------------------|
| Country | Telephone | Facsimile | Email |
| LIBYA | +218/92 304 48 74 | +218/21 713 21 12 | info@htds.fr |
| MADAGASCAR | +33 1 64 86 28 28 | +33 1 69 07 69 54 | info@htds.fr |
| MALAWI | +27 11 564 2400 | +27 11 564 2440 | info.za@perkinelmer.com |
| MALI | +33 1 64 86 28 28 | +33 1 69 07 69 54 | info@htds.fr |
| MAURITANIA | +33 1 64 86 28 28 | +33 1 69 07 69 54 | info@htds.fr |
| MAURITIUS | +27 11 564 2400 | +27 11 564 2440 | info.za@perkinelmer.com |
| MOROCCO | +212/(0)522 27 49 59 | +212/(0)522 20 83 74 | info@htds.fr |
| MOZAMBIQUE | +27 11 564 2400 | +27 11 564 2440 | info.za@perkinelmer.com |
| NAMIBIA | +27 11 564 2400 | +27 11 564 2440 | info.za@perkinelmer.com |
| NIGER | +33 1 64 86 28 28 | +33 1 69 07 69 54 | info@htds.fr |
| NIGERIA | +202 22905306 | +202 22905307 | info@htds.fr |
| REUNION ISLANDS | +33 1 64 86 28 28 | +33 1 69 07 69 54 | info@htds.fr |
| RWANDA | +33 1 64 86 28 28 | +33 1 69 07 69 54 | info@htds.fr |
| SENEGAL | +33 1 64 86 28 28 | +33 1 69 07 69 54 | info@htds.fr |
| SEYCHELLES | +33 1 64 86 28 28 | +33 1 69 07 69 54 | info@htds.fr |
| SIERRA LEONE | +202 22905306 | +202 22905307 | info@htds.fr |
| SOMALIA | +202 22905306 | +202 22905307 | info@htds.fr |
| REPUBLIC OF SOUTH AFRICA | +27 564 2400 | +27 564 2440 | info.za@perkinelmer.com |
| SWAZILAND | +27 11 564 2400 | +27 11 564 2440 | info.za@perkinelmer.com |
| TANZANIA | +202 22905306 | +202 22905307 | info@htds.fr |
| TOGO | +33 1 64 86 28 28 | +33 1 69 07 69 54 | info@htds.fr |
| TUNISIA | +216 70 836 961 | +216 70 836 561 | info@htds.fr |
| UGANDA | +202 22905306 | +202 22905307 | info@htds.fr |
| WESTERN SAHARA | +33 1 64 86 28 28 | +33 1 69 07 69 54 | info@htds.fr |
| ZAMBIA | +27 11 564 2400 | +27 11 564 2440 | info.za@perkinelmer.com |
| ZIMBABWE | +27 11 564 2400 | +27 11 564 2440 | info.za@perkinelmer.com |

| AMERICAS | | | |
|-----------|------------------|------------------|------------------------------------|
| Country | Telephone | Facsimile | Email |
| ARGENTINA | 54 11 4554 4004 | 54 11 4554 2807 | |
| BOLIVIA | (591 2) 241 5446 | (591 2) 241 0639 | beco@entelnet.bo |
| BRAZIL | 55 11 3868 6200 | 55 11 3868 6210 | consumiveis.vendas@perkinelmer.com |
| CANADA | 800 561 4646 | 905 851 1814 | Orders.LSCanada@perkinelmer.com |
| CHILE | 56 2 784 7500 | 56 2 236 6821 | |
| COLUMBIA | (574) 230 57 67 | (574) 230 56 04 | |

AMERICAS

| Country | Telephone | Facsimile | Email |
|--------------------|-------------------|-------------------|--------------------------------|
| COSTA RICA | (506) 2 272 4700 | (506) 2 272 9700 | |
| DOMINICAN REPUBLIC | (809) 508 6500 | (809) 532 0741 | |
| ECUADOR | (593) 222 63 537 | (593) 224 56 556 | |
| EL SALVADOR | (503)2535 0700 | (503)2535 0777 | |
| GUATEMALA | (502) 25 02 47 00 | (502) 25 02 47 01 | |
| HONDURAS | (504) 2262 6700 | (504) 2262 4000 | |
| MEXICO | 52 55 5337 0700 | 52 55 559 36223 | CC.Mexico@perkinelmer.com |
| NICARAGUA | (505) 2 278 0177 | (505) 278 0279 | |
| PANAMA | 507 3941 695 | 52 55 559 36223 | |
| PARAGUAY | (598) 291 69857 | (598) 291 69857 | info@aldenor.com.uy |
| PERU | (511) 201 5800 | (511) 444 9937 | |
| PUERTO RICO | 787 783 3067 | 787 793 7198 | |
| TRINIDAD | (868) 671 1525 | (868) 665 3703 | |
| UNITED STATES | 800 762 4000 | 203 944 4904 | CustomerCareUS@perkinelmer.com |
| URUGUAY | (598) 291 69857 | (598) 291 69857 | info@aldenor.com.uy |
| VENEZUELA | 58 212 7614757 | 58 212 7623050 | |

ASIA

| Country | Telephone | Facsimile | Email |
|----------------|---------------------------------|------------------|---|
| AFGANISTAN | +92 21 5345581 | +92 21 5345582 | sales@amspvtltd.com |
| ARMENIA | +7 495 935 8888 | +7 495 564 8787 | info@scheltec.ru |
| AUSTRALIA | 61 3 9212 8500 or 1 800 033 391 | 61 3 9212 8595 | http://go.perkinelmer.com/Consumables |
| AZERBAIJAN | +90 212 212 5566 | +90 212 212 2829 | istanbul@tetratek.com.tr |
| CHINA | 86 8008205046 | 86 2160645666 | consumable.china@perkinelmer.com |
| GEORGIA | +7 495 935 8888 | +7 495 564 8787 | info@scheltec.ru |
| HONG KONG | 852 2793 3218 | 852 2793 3225 | info@aldenor.com.uy |
| INDIA | +91 22 33261700 | +91 22 33261790 | marketing.india@perkinelmer.com |
| INDONESIA | 62 21 5694 5040 to 43 | 62 21 5694 5024 | |
| JAPAN Kyushu | 81 92 473 7001 | 81 92 473 8353 | scalar@tsst.ent.tt |
| JAPAN Osaka | 81 6 6386 6004 | 81 6 6386 7009 | |
| JAPAN Tokyo | 81 3 3866 2647 | 81 3 3866 2652 | info@aldenor.com.uy |
| JAPAN Yokahama | 81 45 339 5861 | 81 45 339 5871 | |
| KAZAKHSTAN | +7 495 935 8888 | +7 495 564 8787 | info@scheltec.ru |
| KOREA | 82 2 868 5376 | 82 2 868 4343 | http://go.perkinelmer.com/Consumables |
| KYRGYZSTAN | +7 495 935 8888 | +7 495 564 8787 | info@scheltec.ru |

ORDERING INFORMATION

| ASIA | | | |
|---------------------------------|--------------------------------|------------------|---|
| Country | Telephone | Facsimile | Email |
| MALAYSIA | 603 7949 1118 | 603 7949 1119 | http://go.perkinelmer.com/Consumables |
| MONGOLIA | +7 495 935 8888 | +7 495 564 8787 | info@scheltec.ru |
| NEW ZEALAND | 64 21 215 1198 or 0800 724 663 | 64 3 384 1222 | http://go.perkinelmer.com/Consumables |
| PAKISTAN | +92 21 5345581 | +92 21 5345582 | sales@amspvtltd.com |
| PHILIPPINES | 632 822 0511 to 16 | 632 822 0517 | http://go.perkinelmer.com/Consumables |
| RUSSIAN FEDERATION | +7 495 935 8888 | +7 495 564 8787 | info@scheltec.ru |
| SINGAPORE | 65 6868 1650 | 65 6872 6595 | http://go.perkinelmer.com/Consumables |
| TAIWAN Taipei | 886 2 27647199 | 886 2 27647209 | http://go.perkinelmer.com/Consumables |
| TAIWAN Kaohsiung | 886 7 5521030 | 886 7 5543402 | http://go.perkinelmer.com/Consumables |
| TAJIKISTAN | +7 495 935 8888 | +7 495 564 8787 | info@scheltec.ru |
| THAILAND | 662 319 7901 | 662 319 7900 | http://go.perkinelmer.com/Consumables |
| TURKEY | +90 212 312 1100 | +90 212 312 1111 | cc.turkey@perkinelmer.com |
| TURKMENISTAN | +7 495 935 8888 | +7 495 564 8787 | info@scheltec.ru |
| VIETNAM Hanoi | 84 4 3747 2258 | 84 4 3747 2260 | http://go.perkinelmer.com/Consumables |
| VIETNAM Ho Chi Minh City | 84 8 5431 8877 | 84 8 5431 8570 | http://go.perkinelmer.com/Consumables |
| UZBEKISTAN | +7 495 935 8888 | +7 495 564 8787 | info@scheltec.ru |

| MIDDLE EAST & GULF | | | |
|--------------------------------|-------------------|-------------------|--|
| Country | Telephone | Facsimile | Email |
| BAHRAIN | +973 17276176 | +973 17275819 | info@ymh.com.bh |
| GAZA STRIP | +202 22905306 | +202 22905307 | info@htds.fr |
| IRAQ | +202 22905306 | +202 22905307 | info@htds.fr |
| ISRAEL | 1700 500512 | 1700 555 915 | cc.israel@perkinelmer.com |
| JORDAN | +962(0)6 534 6523 | +962(0)6 534 6527 | info@htds.fr |
| KUWAIT | +965 22419797 | +965 22419798 | las@emphor.biz |
| LEBANON | +202 22905306 | +202 22905307 | info@htds.fr |
| OMAN | +968 248 14752 | +968 248 13924 | big@bigllcoman.com |
| PALESTINIAN TERRITORIES | +202 22905306 | +202 22905307 | info@htds.fr |
| QATAR | +974 4654563 | +974 4652256 | las@emphor.biz |
| SAUDI ARABIA | +966 11477 7932 | +966 11477 1314 | info@aralgosaibico.com |
| UNITED ARAB EMIRATES | +971 4 883 0233 | +971 4 883 0133 | las@emphor.biz |
| WEST BANK | +202 22905306 | +202 22905307 | info@htds.fr |
| YEMEN | +967 234 5073 | +967 234 0504 | direct@alfalahye.net |

| EUROPE | | | |
|--------------------|-------------------|-------------------|----------------------------|
| Country | Telephone | Facsimile | Email |
| ALBANIA | 0800 111 933 | 0800 111 934 | cc.export@perkinelmer.com |
| AUSTRIA | 0800 111 933 | 0800 111 934 | cc.austria@perkinelmer.com |
| BELARUS | +7 495 935 8888 | +7 495 564 8787 | info@scheltec.ru |
| BELGIUM | 0800 40858 | 0800 40859 | cc.benelux@perkinelmer.com |
| BOSNIA HERZEGOVINA | +385 1 2001 767 | +385 1 2001 724 | hebe@hebe.hr |
| BULGARIA | +359 2 952 0301 | +359 2 952 3784 | chroma@spnet.net |
| CROATIA | +385 1 2001 767 | +385 1 2001 724 | hebe@hebe.hr |
| CYPRUS | +357 22 33 82 34 | +357 22 33 82 32 | sales@kriticos.com.cy |
| CZECH REPUBLIC | +420 241 430 534 | +420 241 430 535 | info@pesystems.cz |
| DENMARK | 8088 4236 | 8088 4237 | cc.nordic@perkinelmer.com |
| ESTONIA | +372 7 383 330 | +372 7 383 360 | kent@lanlab.ee |
| FINLAND | 0800 117 186 | 0800 117 185 | cc.nordic@perkinelmer.com |
| FRANCE | 0805 111 333 | 0805 111 334 | cc.france@perkinelmer.com |
| GERMANY | 0800 181 0032 | 0800 181 0031 | cc.germany@perkinelmer.com |
| GREECE | +30 2310 322525 | +30 2310 321912 | antisel@antisel.gr |
| HUNGARY | +36 1 251 1116 | +36 1 251 1461 | perform@perform.hu |
| ICELAND | +354 412 7000 | +354 412 7099 | medor@medor.is |
| IRELAND | 1800 932 886 | 1800 932 884 | cc.ie@perkinelmer.com |
| ISRAEL | 1700 500 512 | 1700 555 915 | cc.israel@perkinelmer.com |
| ITALY | +39 800 906 642 | +39 02 3601 2508 | cc.italy@perkinelmer.com |
| LATVIA | +371 6755 1894 | +371 6755 1976 | info@adrona.lv |
| LITHUANIA | +370 5 2638748 | +370 5 2638749 | info@linealibera.it |
| LUXEMBOURG | 0800 26588 | 0800 26589 | cc.benelux@perkinelmer.com |
| MACEDONIA | +381 11 22 22 244 | +381 11 22 22 244 | perkinelmer@superlab.rs |
| MALTA | +39 081 7013094 | +39 081 7021977 | info@areachem.it |
| MOLDAVIA | +40 21 316 2877 | +40 21 316 2876 | office@cromatec.ro |
| MONTENEGRO | +381 11 22 22 244 | +381 11 22 22 244 | perkinelmer@superlab.rs |
| NETHERLANDS | 0800 0234490 | 0800 0234491 | cc.benelux@perkinelmer.com |
| NORWAY | 800 18 854 | 800 18 855 | cc.nordic@perkinelmer.com |
| POLAND | 0800 88 08 88 | +48 22 310 88 01 | cc.pl@perkinelmer.com |
| PORTUGAL | +351 21 782 60 30 | +351 21 782 60 39 | ilc@ilc.pt |
| ROMANIA | +40 21 316 2877 | +40 21 316 2876 | office@cromatec.ro |
| RUSSIAN FEDERATION | +7 495 935 8888 | +7 495 564 8787 | info@scheltec.ru |
| SERBIA | +381 11 22 22 244 | +381 11 22 22 244 | perkinelmer@superlab.rs |

ORDERING INFORMATION

| EUROPE | | | |
|-----------------------|----------------------|------------------|-----------------------------------|
| Country | Telephone | Facsimile | Email |
| SLOVAKIA | +421 918 506782 | +421 48 2301628 | m1a@mediclabor.sk |
| SLOVENIA | +386 1 427 3213/3650 | +386 1 427 3191 | omega@omega.si |
| SPAIN | 800 099 164 | 800 099 165 | atencionalcliente@perkinelmer.com |
| SWEDEN | 0200 887 520 | 0200 887 521 | cc.nordic@perkinelmer.com |
| SWITZERLAND | 0800 000 015 | 0800 000 016 | cc.switzerland@perkinelmer.com |
| TURKEY | +90 212 312 1100 | +90 212 312 1111 | cc.turkey@perkinelmer.com |
| UKRAINE | +7 495 935 8888 | +7 495 564 8787 | info@scheltec.ru |
| UNITED KINGDOM | 0800 89 60 46 | 0800 89 17 14 | cc.uk@perkinelmer.com |

Ordering Information

Order Online

Place your order online at:

www.perkinelmer.com/shop

Online ordering is currently available in Australia, Austria, Belgium, Canada, China, Denmark, Finland, France, Germany, Ireland, Italy, Luxembourg, the Netherlands, Norway, Puerto Rico, Singapore, Spain, Sweden, Switzerland, the United Kingdom and the United States.

Order by Phone, Fax or E-mail

Please contact your local PerkinElmer Customer Care Representative. See local office listings to the left. Or visit www.perkinelmer.com/lasoffices.

Order by Mail

Visit us online at www.perkinelmer.com/lasoffices to obtain the correct address for mailing your company Purchase Order.

Return Goods Policy

Before returning any item to PerkinElmer, please obtain a Return Authorization Number from a customer service representative. Call your local PerkinElmer office and please have the following information ready:

- Our Order Number or your Purchase Order Number
- The PerkinElmer part numbers of the items that you wish to return
- Reason for return

Our customer service representative will provide you with a Return Authorization Number and the return address. We cannot accept any returns without a Return Authorization Number. Policy may vary. Please contact your local PerkinElmer representative for details.

Technical Support

For technical assistance, please contact your local PerkinElmer Customer Care Representative. See local office listings.

Check with your local PerkinElmer Customer Care center for current pricing.

PerkinElmer and the PerkinElmer logo are registered trademarks of PerkinElmer, Inc. All other product and company names mentioned herein may be the trademarks or registered trademarks of their respective owners.

PerkinElmer is not responsible for typographical or photographic errors that may appear in this catalog. We reserve the right to make adjustments or corrections due to changing market conditions, product discontinuations, or typographical or photographic errors in advertisements or product descriptions. Terms and conditions and item availability are subject to change without notice.

Terms and Conditions

For details on our terms and conditions, including warranties, please visit: www.perkinelmer.com/terms

Table of Contents

| | |
|--------------------------------|---------|
| Atomic Absorption | 14-33 |
| ICP-OES | 34-47 |
| ICP-MS | 48-59 |
| Atomic Spectroscopy General | 60-97 |
| Sample Preparation | 100-121 |
| Liquid Chromatography | 122-171 |
| Gas Chromatography | 172-245 |
| FT-IR | 248-267 |
| UV/Visible | 268-282 |
| Polarimetry | 283 |
| Fluorescence | 284-289 |
| Thermal and Elemental Analysis | 290-299 |
| Part Number Index | 300-331 |
| Alphabetical Index | 332-341 |

HUMAN HEALTH

ENVIRONMENTAL HEALTH

NOTHING
FEELS BETTER THAN
KNOWING YOU HAVE
THE BEST



PinAAcle AA Spectrometers

©2012 PerkinElmer, Inc. 4.00214_01. All rights reserved. PerkinElmer® is a registered trademark of PerkinElmer, Inc. All other trademarks are the property of their respective owners.

Discover the PinAAcle of Performance in AA. Engineered around cutting-edge fiber-optic technology for enhanced light throughput and superior detection limits, the new PinAAcle™ series is the latest innovation from the world leader in atomic absorption. Available in flame, furnace, or combination models, PinAAcle instruments offer exactly the level of performance you need with the smallest footprint of any combined flame/graphite furnace AA system on the market. Experience peak performance and unmatched productivity. Step up to the PinAAcle series from PerkinElmer.

www.perkinelmer.com/pinaacle

PerkinElmer®
For the Better

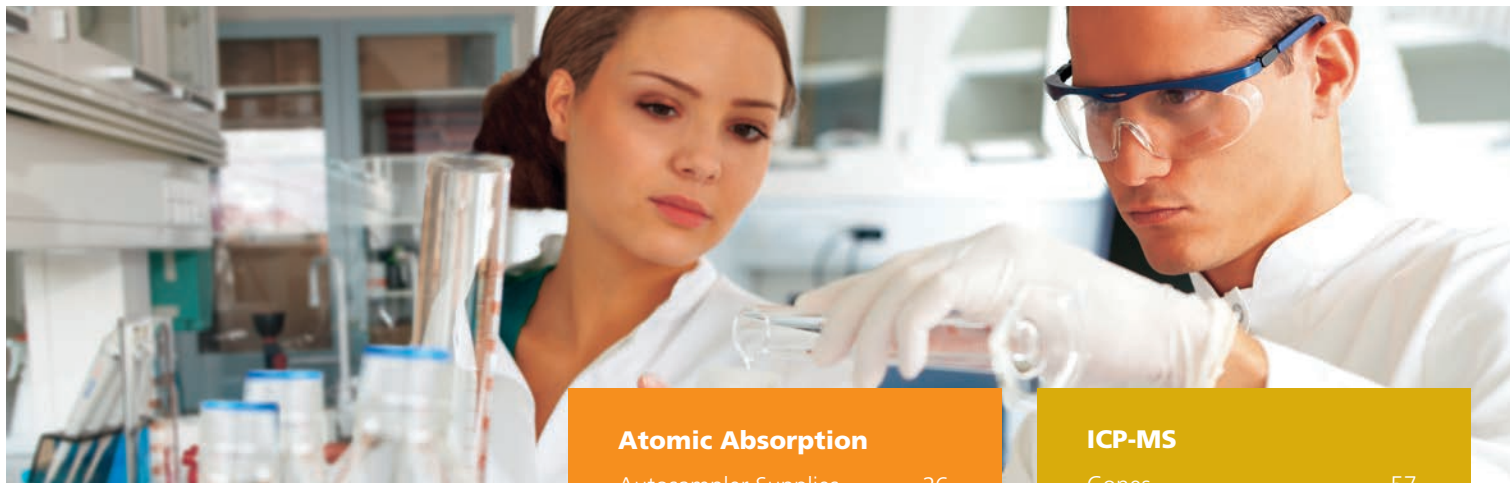

ATOMIC SPECTROSCOPY

PerkinElmer is the world leader in atomic spectroscopy solutions for atomic absorption (AA), inductively coupled plasma optical emission spectroscopy (ICP-OES) and inductively coupled plasma mass spectrometry (ICP-MS). With instruments that are the industry standard worldwide, PerkinElmer accessories, consumables, methods and application support meet the most demanding requirements and are the preferred choice in thousands of laboratories globally.

We invest heavily in testing and validating our complete portfolio of solutions to ensure that you receive accurate, repeatable results, on-time, every time throughout the lifetime of your instrument. From Lumina hollow cathode lamps that allow automatic setup and provide long lamp lifetime to our pure standards that have been analyzed and certified to yield reliable, accurate results, you'll be able to relax knowing you have the best. We also offer a complete portfolio of specialized consumables that deliver reliable performance, control operating costs and maximize the uptime of your instrument.

When you order our precision-designed, genuine Atomic Spectroscopy PerkinElmer consumables and supplies, you'll get the results you need - accurately and on time.

| Atomic Absorption | |
|---------------------------|-------|
| Autosampler Supplies | 26 |
| Burner System | |
| Components | 20-21 |
| Compressors | 27 |
| Graphite | 28-32 |
| Lamps | 14-19 |
| Mercury Analyzer Supplies | 33 |
| Nebulizers | 22-25 |

| ICP-OES | |
|---------------------------------|-----------|
| Benches and Carts | 47 |
| Compressors | 46 |
| Injectors and Adapters | 44 |
| Load Coils and Purge Components | 45 |
| Nebulizers | 34-37 |
| Sample Introduction Kits | 41 |
| Spray Chambers | 38-39 |
| Torch Modules and Torches | 40, 42-43 |

| ICP-MS | |
|-----------------------------|-------|
| Cones | 57 |
| Detectors | 56 |
| Injectors and Adapters | 54 |
| Load Coils | 55 |
| Mass Spectrometer Hardware | 56 |
| Nebulizers | 48-50 |
| Sample Introduction Systems | 58-59 |
| Spray Chambers | 51-53 |
| Torches | 55 |
| Vacuum Pump Supplies | 56 |

| Atomic Spectroscopy/ General | |
|-------------------------------------|-------|
| Autosampler Supplies | 63-65 |
| Benches and Carts | 47 |
| Cooling Systems | 87 |
| Filters and Regulators | 90-91 |
| Flow Injection Supplies (FIAS/FIMS) | 66-67 |
| Internal Standards Kits | 61 |
| Mercury Analyzer Supplies | 33 |
| Microwave Sample Preparation | 95-97 |
| Noise Enclosures | 88 |
| Power Conditioners and UPS Systems | 89 |
| Pump Tubing | 60-62 |
| Sample Preparation | 92-94 |
| Standards | 68-86 |
| Trays and Racks | 64 |



WORLD LEADER IN AA, ICP-OES AND ICP-MS



AAnalyst 200/400 Atomic Absorption Spectrometers

Whether you choose the AAnalyst™ 200 or AAnalyst 400™, you'll discover an easy, affordable and reliable flame atomic absorption (AA) solution. We've simplified the process of AA analysis, from sample introduction to results. We've made it easy for anyone with a basic understanding of AA to get fast, reliable results every time, and we've made the quality and reliability of PerkinElmer available to everyone with these affordable systems.

Easy to use, easy to own, and featuring many of the advances that have made PerkinElmer the market leader, the AAnalyst 200 and 400 are the perfect choice for any laboratory needing a reliable, trouble-free solution for flame AA analysis.



PinAAcle 900 Atomic Absorption Spectrometers

The PinAAcle™ series of atomic absorption (AA) spectrometers brings AA performance to new heights. Engineered with an array of exciting technological advances, it offers a variety of configurations and capabilities to deliver exactly the level of performance you need:

- Flame only, furnace only, or space-saving stacked designs featuring both
- Flame, furnace, flow injection, FIAS-furnace and mercury/hydride capabilities on a single instrument
- Choice of Deuterium or longitudinal Zeeman background correction
- TubeView™ color furnace camera simplifies autosampler tip alignment and sample dispensing
- Proven Syngistix™ software offering both ease-of-use and exceptional flexibility

And no matter which model you select (900F, 900Z, 900H, 900T), you'll discover an intuitive, highly efficient system capable of simplifying your journey from sample to results – even with the most difficult matrices.

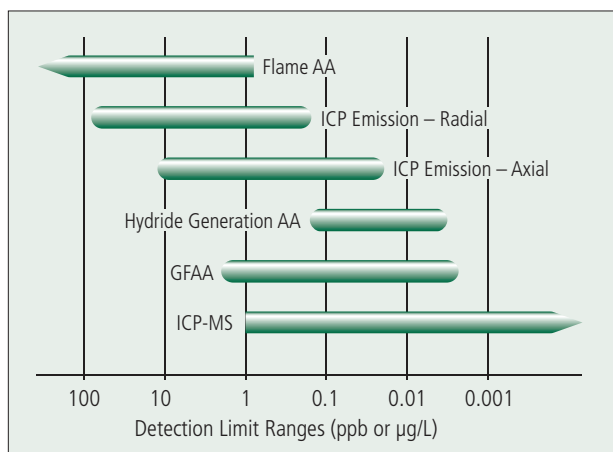

Typical detection limit ranges for the major atomic spectroscopy techniques.

PinAAcle 900 nebulizers are adjustable for optimized performance and include easily replaceable capillary assemblies and venturis for simple, reduced cost maintenance.





Optima 8x00 ICP-OES Spectrometers

With its groundbreaking features and expanded capabilities, the Optima® 8x00 series is more than just an evolution of the world's most popular ICP-OES... it's a revolution. Built around the proven design of the Optima platform, the 8x00 series delivers breakthrough performance through a series of cutting-edge technologies that optimize sample introduction, enhance plasma stability, simplify method development and dramatically reduce operating costs:

- Adjustable Torch Cassette - makes it easy to optimize performance - even with the most difficult samples and offers simple maintenance.
- Flat Plate™ Plasma Technology – with a patented, maintenance-free RF generator uses half the argon of traditional systems dramatically reducing operating costs.
- PlasmaCam™ Viewing Camera – offers continuous viewing of the plasma, simplifying method development and enabling remote diagnostic capabilities for maximum uptime.



Quick-change adjustable torch mount



NexION 350 ICP-MS Spectrometers

With a data acquisition speed 10 times faster than any other ICP-MS on the market, the NexION® 350 ICP-MS opens up a whole new world of efficiency and opportunity:

- 100,000 data points per second
- Ideal for applications that require fast transient signal analysis, such as speciation and laser ablation
- Complete characterization of nanoparticles

In addition to the exceptional application flexibility afforded by its speed, the instrument also delivers superior uptime and productivity through a variety of unique features engineered to enhance signal stability:

- Triple Cone Interface produces the industry's most tightly focused ion beam and prevents sample deposition on internal components.
- Quadrupole Ion Deflector turns positively charged ions 90° into the Universal Cell and filters off neutrals.
- Analyzing Quadrupole made of a unique steel alloy for negligible thermal expansion for unparalleled stability.
- No extraction lenses to clean for minimized maintenance.

Triple cone interface produces the most tightly focused ion beam in the industry, reducing build-up on internal components so maintenance and cleaning are minimized.



DESIGNING AND MANUFACTURING EXPERTISE



PERKINELMER HAS 40 YEARS OF EXPERTISE DESIGNING AND MANUFACTURING HOLLOW CATHODE LAMPS.

Features and Benefits

- **Long Life:** PerkinElmer's larger lamp volume results in longer lamp lifetime
- **Automation:** PerkinElmer coded lamps allow automatic setup
- **Easy Installation:** It's as simple as sliding the lamp into the instrument's lamp bracket or turret
- **Complete Compatibility:** Lumina hollow cathode lamps can be used with PerkinElmer's entire range of atomic absorption spectrometers
- **Testing:** Every lamp is thoroughly tested before leaving the factory
- **Quality:** Carefully selected materials used in the manufacturing of our lamps avoid spectral interference
- **Design:** Our design provides you with the low detection limits needed for your most difficult determinations
- **Selection:** PerkinElmer offers a wide selection of single-element and multi-element lamps
- **Easy To Order:** It's easy to find the right lamp for your analytical needs — simply use the selection charts on this page or visit our website for a complete listing
- **Warranty:** The performance of every PerkinElmer lamp is fully warranted*

Lumina Single-Element Hollow Cathode Lamps

| Element Name | Element Symbol | Lumina Lamp Part No. | Lumina Lamp with Intensitron® Adapter Part No. |
|--------------|----------------|----------------------|--|
| Aluminum | Al | N3050103 | N3050303 |
| Antimony | Sb | N3050170 | N3050370 |
| Arsenic | As | N3050105 | N3050305 |
| Barium | Ba | N3050109 | N3050309 |
| Beryllium | Be | N3050110 | N3050310 |
| Bismuth | Bi | N3050111 | N3050311 |
| Boron | B | N3050108 | N3050308 |
| Cadmium | Cd | N3050115 | N3050315 |
| Calcium | Ca | N3050114 | N3050314 |
| Chromium | Cr | N3050119 | N3050319 |
| Cobalt | Co | N3050118 | N3050318 |
| Copper | Cu | N3050121 | N3050321 |
| Dysprosium | Dy | N3050122 | N3050322 |
| Erbium | Er | N3050123 | N3050323 |
| Europium | Eu | N3050124 | N3050324 |
| Gadolinium | Gd | N3050129 | N3050329 |
| Gallium | Ga | N3050128 | N3050328 |
| Germanium | Ge | N3050130 | N3050330 |
| Gold | Au | N3050107 | N3050307 |
| Hafnium | Hf | N3050133 | N3050333 |
| Holmium | Ho | N3050135 | N3050335 |
| Indium | In | N3050137 | N3050337 |
| Iridium | Ir | N3050138 | N3050338 |
| Iron | Fe | N3050126 | N3050326 |
| Lanthanum | La | N3050141 | N3050341 |
| Lead | Pb | N3050157 | N3050357 |
| Lithium | Li | N3050142 | N3050342 |
| Magnesium | Mg | N3050144 | N3050344 |
| Manganese | Mn | N3050145 | N3050345 |
| Mercury | Hg | N3050134 | N3050334 |
| Molybdenum | Mo | N3050146 | N3050346 |
| Neodymium | Nd | N3050150 | N3050350 |
| Nickel | Ni | N3050152 | N3050352 |
| Niobium | Nb | N3050149 | N3050349 |
| Palladium | Pd | N3050158 | N3050358 |
| Phosphorus | P | N3050155 | N3050355 |
| Platinum | Pt | N3050162 | N3050362 |
| Potassium | K | N3050139 | N3050339 |
| Praseodymium | Pr | N3050161 | N3050361 |
| Rhenium | Re | N3050165 | N3050365 |
| Rhodium | Rh | N3050166 | N3050366 |

Chart continues on next page

PERKINELMER EXCLUSIVE 6/24 WARRANTY*

Lumina™ Hollow Cathode Lamps

1. We warrant that during the first six months or after 5,000 milliampere-hours of operation, whichever comes first, from initial date of shipment, the lamps will meet or exceed the intensity and absorption specifications to which all new lamps are tested.
2. All our hollow cathode lamps are warranted to light and emit the spectra of the element indicated for two years or 5,000 milliampere-hours of operation from the date of the shipment, whichever comes first.
3. If any lamp fails before the expiration of the warranty period, it will be replaced free of charge.

*The lamp warranty is void for lamps which sustain physical damage or are operated at power levels substantially above or below the power level recommended on the lamp label. The lamp warranty may vary in different countries.



| Element Name | Element Symbol | Lumina Lamp Part No. | Lumina Lamp with Intensitron® Adapter Part No. |
|--------------|----------------|----------------------|--|
| Ruthenium | Ru | N3050168 | N3050368 |
| Samarium | Sm | N3050174 | N3050374 |
| Scandium | Sc | N3050171 | N3050371 |
| Selenium | Se | N3050172 | N3050372 |
| Silicon | Si | N3050173 | N3050373 |
| Silver | Ag | N3050102 | N3050302 |
| Sodium | Na | N3050148 | N3050348 |
| Strontium | Sr | N3050176 | N3050376 |
| Tantalum | Ta | N3050177 | N3050377 |
| Tellurium | Te | N3050180 | N3050380 |
| Terbium | Tb | N3050178 | N3050378 |
| Thallium | Tl | N3050183 | N3050383 |
| Thulium | Tm | N3050184 | N3050384 |
| Tin | Sn | N3050175 | N3050375 |
| Titanium | Ti | N3050182 | N3050382 |
| Tungsten | W | N3050187 | N3050387 |
| Vanadium | V | N3050186 | N3050386 |
| Ytterbium | Yb | N3050190 | N3050390 |
| Yttrium | Y | N3050189 | N3050389 |
| Zinc | Zn | N3050191 | N3050391 |
| Zirconium | Zr | N3050192 | N3050392 |

Lumina Multi-Element Hollow Cathode Lamps

| Element Name | Element Symbol | Lumina Lamp Part No. | Lumina Lamp with Intensitron® Adapter Part No. |
|---|----------------------------|----------------------|--|
| Two-element Lamps | | | |
| Silver, Gold | Ag, Au | N3050201 | N3050401 |
| Calcium, Magnesium | Ca, Mg | N3050202 | N3050402 |
| Calcium, Zinc | Ca, Zn | N3050203 | N3050403 |
| Potassium, Sodium | K, Na | N3050204 | N3050404 |
| Platinum, Ruthenium | Pt, Ru | N3050205 | N3050405 |
| Tin, Tellurium | Sn, Te | N3050206 | N3050406 |
| Three-element Lamps | | | |
| Calcium, Magnesium, Zinc | Ca, Mg, Zn | N3050208 | N3050408 |
| Copper, Iron, Nickel | Cu, Fe, Ni | N3050209 | N3050409 |
| Four-element Lamps | | | |
| Copper, Iron, Manganese, Zinc | Cu, Fe, Mn, Zn | N3050212 | N3050412 |
| Five-element Lamps | | | |
| Silver, Chromium, Copper, Iron, Nickel | Ag, Cr, Cu, Fe, Ni | N3050213 | N3050413 |
| Cobalt, Chromium, Copper, Manganese, Nickel | Co, Cr, Cu, Mn, Ni | N3050214 | N3050414 |
| Six-element Lamps | | | |
| Cobalt, Chromium, Copper, Iron, Manganese, Nickel | Co, Cr, Cu, Fe, Mn, Ni | N3050217 | N3050417 |
| Seven-element Lamps | | | |
| Aluminum, Calcium, Copper, Iron, Magnesium, Silicon, Zinc | Al, Ca, Cu, Fe, Mg, Si, Zn | N3050218 | N3050418 |

MAXIMUM INTENSITY, LONG LIFE



EDLS PROVIDE GREATER LIGHT OUTPUT AND LONGER LIFE THAN CORRESPONDING HCLS

For certain elements such as Arsenic and Selenium, EDLs will also provide improved sensitivity and lower detection limits. System 2 electrodeless discharge lamps provide the optimized spectral output needed to get the maximum performance from PerkinElmer atomic absorption spectrometers.

ELECTRODELESS DISCHARGE LAMPS FOR GREATER BRIGHTNESS

EDLs are typically much brighter and, in some cases, provide better sensitivity than comparable HCLs. EDLs are preferred for certain volatile elements. They offer better precision and lower detection limits for analyses that are “noisy” due to weak hollow cathode emission. PerkinElmer System 2 EDLs consist of the element or a salt of the element sealed in a quartz bulb containing an inert gas atmosphere. When an RF field of sufficient power is applied, the inert gas is ionized and the coupled energy vaporizes the element and excites the atoms inside the bulb, resulting in the emission of the characteristic spectrum.

PerkinElmer’s System 2 EDLs consist of a driver and a lamp sleeve. Depending on the instrument, one or two EDL lamps can be on at the same time. The driver connects to the instrument’s RF power supply (if applicable), or the external power supply if needed. The lamp sleeve contains the pre-aligned bulb for the element of interest. The sleeve has the same exterior dimensions as the PerkinElmer HCLs, allowing System 2 EDLs to be used in the same lamp mounts and turrets.

The locking pin on the lamp driver prevents operation without the lamp sleeve correctly installed on the driver.

Electrodeless Discharge Lamps are an ideal source for determining volatile elements.

Electrodeless Discharge Lamps

| Element Name | Element Symbol | System 2 EDL with Coded Adapter Part No. | AAAnalyst Coded Adapter Part No. |
|--------------|----------------|--|----------------------------------|
| Antimony | Sb | N3050670 | N3050869 |
| Arsenic | As | N3050605 | N3050860 |
| Bismuth | Bi | N3050611 | N3050861 |
| Cadmium | Cd | N3050615 | N3050862 |
| Cesium | Cs | N3050620 | N3050863 |
| Germanium | Ge | N3050630 | N3050864 |
| Lead | Pb | N3050657 | N3050867 |
| Mercury | Hg | N3050634 | N3050865 |
| Phosphorus | P | N3050655 | N3050866 |
| Rubidium | Rb | N3050664 | N3050868 |
| Selenium | Se | N3050672 | N3050870 |
| Tellurium | Te | N3050680 | N3050872 |
| Thallium | Tl | N3050683 | N3050873 |
| Tin | Sn | N3050675 | N3050871 |
| Zinc | Zn | N3050691 | N3050874 |

EDL Driver Assembly required (see right page).



Features and Benefits

- **Brightness:** EDLs are much brighter and, in some cases, provide better sensitivity than comparable hollow cathode lamps
- **Precision:** EDLs offer lower detection limits and are preferred for analyses that are “noisy” due to weak hollow cathode emission
- **Long Life:** System 2 EDLs are long-lived for exceptional cost-effectiveness
- **Automation:** PerkinElmer coded lamps allow automatic set-up on systems with automated turret
- **Quality:** Carefully selected materials used in the manufacturing of our lamps avoid spectral interference
- **Testing:** Every lamp is thoroughly tested
- **Design:** Our design provides you with the low detection limits needed for your most difficult determinations
- **Warranty:** The performance of every PerkinElmer lamp is fully warranted*

EDL ASSEMBLIES AND COMPONENTS

EDL Driver Assemblies

| Description | Part No. |
|---|-----------------|
| For AAnalyst™ 200/400 | N3150131 |
| System 2 EDL driver with a short cable. For use with all instruments that have a built in EDL power supply. Adapter N3150303 is also needed if used on the AAnalyst 200/400. | 03030997 |
| Driver with a long cable. For use with the external power supply, but has the same plug connector as 03030997. Requires adapter N3150303 if used with the AAnalyst 200/400. | 03030793 |

EDL Driver Components

| Description | Part No. |
|---|-----------------|
| Driver Assembly Adapter Cable Allows System 2 EDL Drivers (03030793 and 03030997) to be used on an AAnalyst 200/400. | N3150303 |
| Extension cable for 03030997 if a longer length is needed. | 03030998 |

THE PERKINELMER EXCLUSIVE WARRANTY*

System 2 Electrodeless Discharge Lamps

1. We warrant that during the first six months or after 500 hours of operation, whichever comes first, from initial date of shipment, the lamps will meet or exceed the intensity and absorption specifications to which all new lamps are tested.
2. All our Electrodeless Discharge Lamps are warranted to light and emit the spectra of the element indicated for two years or 1,000 hours of operation from the initial date of shipment, whichever comes first.
3. If any lamp fails before the expiration of the warranty period, it will be replaced free of charge.

* The lamp warranty is void for lamps that sustain physical damage or are operated at power levels substantially above or below the power level recommended on the lamp label. The lamp warranty may vary in different countries.





1.5 INCH LAMPS DESIGNED FOR NON-PERKINELMER INSTRUMENTS

ATOMAX™ 1.5" AA LAMPS FROM PERKINELMER, THE WORLD LEADER IN ATOMIC ABSORPTION

Atomax 1.5" hollow cathode lamps are crafted to the same high standards that have made PerkinElmer 2" Lumina™ hollow cathode lamps the best in the industry. Drawing on more than 40 years of HCL design and manufacturing expertise, Atomax lamps now offer laboratories around the world a dependable, top-quality lighting source, regardless of the brand of AA instruments used.

Value-Priced and Fully Compatible with 1.5" Format AA Instruments

PerkinElmer two pin non-coded Atomax lamps are designed to fit most commercially available atomic absorption instruments including Agilent®, Thermo®, Shimadzu®, GBC®, Analytic Jena®, Hitachi® and many more. Combining affordability and industry-wide compatibility allows users of other brands of AAs to benefit from PerkinElmer's proven lamp performance. Each lamp is thoroughly tested to ensure that it will stand up to the most demanding requirements. Atomax lamps represent an exceptional value, and our money-back guarantee means you can order with complete confidence.

Tested and Validated for Highest Quality Performance

All 1.5" Atomax hollow cathode lamps are thoroughly tested to ensure maximum light output and spectral purity. Comparative results show that Atomax lamps provide equal or better performance than other AA lamps in the market. Precision engineered for high sensitivity, stable light output, low noise, and long life, you can rely on Atomax lamps for the accurate results you need.

Features and Benefits

- **Experts:** Expertise designing and manufacturing quality lamps for over 40 years. A brand you can trust
- **Compatibility:** Compatible with other manufacturer's instruments — tested and approved
- **Lifetime:** Long lifetime and performance. As the world's leading AA supplier, we know how to build lamps that provide maximum light output and spectral purity for optimum performance
- **Quality:** Every lamp ships with Certificate of Quality
- **Testing:** Lamps are thoroughly tested before leaving the factory
- **Raw Materials:** Carefully selected materials used in the manufacturing of our lamps avoid spectral interference
- **Clean:** Lamps are built to stringent specifications in a state-of-the-art lamp manufacturing facility. Great quality every time
- **Design:** Our design provides you with the low detection limits needed for your most difficult determinations
- **Value:** Equivalent or better performance than your current lamp at a great price

Every Atomax lamp includes a certificate of quality, our promise of outstanding performance levels from the leader in AA.

Atomax™ Certificate of Quality

High quality equivalent lamps for all major instrument manufacturers.

- ✓ Each lamp is designed and tested to ensure optimal performance on PerkinElmer and other manufacturer's instruments.
- ✓ Test data for each lamp is stored and tracked by serial number allowing performance data to be retrieved on an individual basis rather than conventional batch testing.
- ✓ Rigid quality control assures that all lamps meet the same high standard for intensity, stability, and spectral purity.
- ✓ Carefully selected materials used in the manufacturing of our lamps avoids spectral interference.
- ✓ Every Atomax lamp has a warranty of 5,000 milliamper-hours.*

* Please refer to warranty card for full details.

Please retain for your records.

09218_03





PERKINELMER EXCLUSIVE 6/24 WARRANTY* ATOMAX™ HOLLOW CATHODE LAMPS

1. We warrant that during the first six months for 5,000 milliampere-hours of operation, whichever comes first, from initial date of shipment, the lamps will meet or exceed the intensity and absorption specifications to which all new lamps are tested.
2. All of our hollow cathode lamps are warranted to light and emit the spectra of the element indicated for two years or 5,000 milliampere hours of operation from the date of the shipment, whichever comes first.
3. If any lamp fails before the expiration of the warranty period, it will be replaced free of charge.

* The lamp warranty is void for lamps which sustain physical damage or are operated at power levels substantially above or below the power level recommended on the lamp label. The lamp warranty may vary in different countries.

| Element | Symbol | Part No. |
|------------|--------|----------|
| Aluminum | Al | N2025301 |
| Antimony | Sb | N2025347 |
| Arsenic | As | N2025302 |
| Barium | Ba | N2025305 |
| Beryllium | Be | N2025306 |
| Bismuth | Bi | N2025307 |
| Boron | B | N2025304 |
| Cadmium | Cd | N2025309 |
| Calcium | Ca | N2025308 |
| Cesium | Cs | N2025312 |
| Chromium | Cr | N2025311 |
| Cobalt | Co | N2025310 |
| Copper | Cu | N2025313 |
| Dysprosium | Dy | N2025314 |
| Erbium | Er | N2025315 |
| Europium | Eu | N2025316 |
| Gadolinium | Gd | N2025319 |
| Gallium | Ga | N2025318 |
| Germanium | Ge | N2025320 |
| Gold | Au | N2025303 |
| Hafnium | Hf | N2025321 |
| Holmium | Ho | N2025323 |
| Indium | In | N2025324 |

| Element | Symbol | Part No. |
|--------------|--------|----------|
| Iridium | Ir | N2025325 |
| Iron | Fe | N2025317 |
| Lanthanum | La | N2025327 |
| Lead | Pb | N2025339 |
| Lithium | Li | N2025328 |
| Lutetium | Lu | N2025329 |
| Magnesium | Mg | N2025330 |
| Manganese | Mn | N2025331 |
| Mercury | Hg | N2025322 |
| Molybdenum | Mo | N2025332 |
| Neodymium | Nd | N2025335 |
| Nickel | Ni | N2025336 |
| Niobium | Nb | N2025334 |
| Osmium | Os | N2025337 |
| Palladium | Pd | N2025340 |
| Phosphorus | P | N2025338 |
| Platinum | Pt | N2025342 |
| Potassium | K | N2025326 |
| Praseodymium | Pr | N2025341 |
| Rhenium | Re | N2025344 |
| Ruthenium | Ru | N2025346 |
| Rhodium | Rh | N2025345 |
| Rubidium | Rb | N2025343 |

| Element | Symbol | Part No. |
|-----------|--------|----------|
| Samarium | Sm | N2025351 |
| Scandium | Sc | N2025348 |
| Selenium | Se | N2025349 |
| Silicon | Si | N2025350 |
| Silver | Ag | N2025300 |
| Sodium | Na | N2025333 |
| Strontium | Sr | N2025353 |
| Tantalum | Ta | N2025354 |
| Terbium | Tb | N2025355 |
| Tellurium | Te | N2025356 |
| Thallium | Tl | N2025359 |
| Thorium | Th | N2025357 |
| Thulium | Tm | N2025360 |
| Tin | Sn | N2025352 |
| Titanium | Ti | N2025358 |
| Tungsten | W | N2025362 |
| Vanadium | V | N2025361 |
| Ytterbium | Yb | N2025364 |
| Yttrium | Y | N2025363 |
| Zinc | Zn | N2025365 |
| Zirconium | Zr | N2025366 |

Graphite for Non-PerkinElmer Instruments can be found in the graphite section.



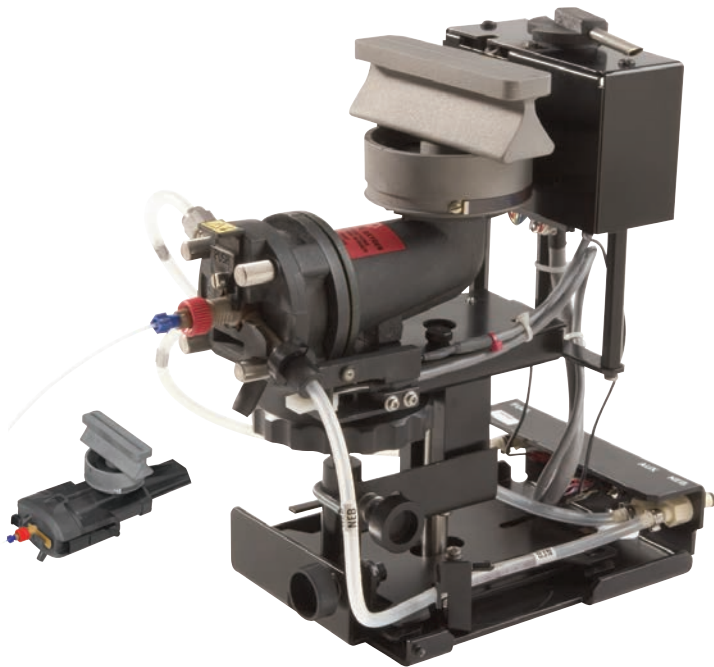

An efficient burner system is essential for obtaining optimal performance from your AA instrument, and proper maintenance is required to obtain precise and accurate determinations.

Features & Benefits

- 100% titanium burner heads, an exclusive PerkinElmer feature that provides maximum corrosion resistance when analyzing any type of sample
- Burner chambers constructed of inert, wettable plastic to allow for proper drainage of excess sample and minimize sample carryover of previous analyses
- Multivaned flow spoilers remove large sample droplets from the nebulized spray and reduce susceptibility to analytical interference
- Gaskets designed for use with aqueous and organic samples. Choose from synthetic rubber gaskets for aqueous solutions and Corkprene or KALREZ gaskets for organic solutions
- PinAAcle uses the same Burner Heads as AAnalyst series. The latest design has a hole on the rim for ease of rotation during operation. The handle is provided with the instrument

EXPERIENCE OPTIMAL EFFICIENCY

Single-slot Nitrous Oxide-acetylene 5 cm

The 5 cm nitrous oxide burner head is required for nitrous oxide-acetylene operation. This burner head can also be used with air-acetylene or rotated to provide reduced sensitivity.

| Description | Part No. |
|--|-----------------|
| Single-slot Nitrous Oxide-acetylene 5 cm | N0400100 |

Single-slot Air-acetylene 10 cm

The 10 cm burner head is designed to be used with the air-acetylene flame. Because of its long burner path length, it provides the best sensitivity for air-acetylene elements.

| Description | Part No. |
|---------------------------------|-----------------|
| Single-slot Air-acetylene 10 cm | N0400102 |

Single-slot Air-acetylene 5 cm

A 5 cm air-acetylene burner head is available for applications in which reduced sensitivity is required. It can be rotated to provide further sensitivity reduction, and it has a wide slot to prevent clogging.

| Description | Part No. |
|--------------------------------|-----------------|
| Single-slot Air-acetylene 5 cm | N0400101 |

Three-slot Air-acetylene 10 cm

The three-slot burner head is designed to be used when analyzing samples with high concentrations of dissolved solids. The three-slot burner head is not compatible with some older gas control systems.

| Description | Part No. |
|--------------------------------|-----------------|
| Three-slot Air-acetylene 10 cm | N0400103 |



PinAAcle Burner Chamber Assembly

- A** Burner Head
- B** Burner head o-ring
- C** Spray chamber
- D** Flow spoiler
- E** End Cap Assembly
- F** Stainless Steel Nebulizer
- G** Retaining ring
- H** Burner head adjustment tool

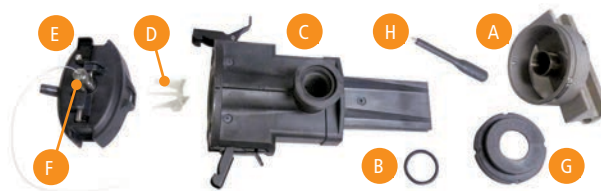

PinAAcle Burner Chamber Assembly

Burner Heads

| Description | Length | Flame Type | PinAAcle 900 Part No. | AAAnalyst 100/200/300/400/700/800 Part No. |
|---|--------|-------------------------|-----------------------|--|
| Single-slot | 5 cm | Nitrous Oxide-Acetylene | N0400100 | N0400100 |
| Single-slot* | 10 cm | Air-Acetylene | N0400102 | N0400102 |
| Three-slot | 10 cm | Air-Acetylene | N0400103 | N0400103 |
| Single-slot | 5 cm | Air-Acetylene | N0400101 | N0400101 |
| Burner Head Adjustment Tool Burner for burner heads with adjustment tool hole | | | N3161040 | N3161040 |

* Standard burner head shipped with PinAAcle instrument.

Burner System Components

| Description | PinAAcle 900 Part No. | AAAnalyst 100/200/300/400/700/800 Part No. |
|---|-----------------------|--|
| Viton Burner Head O-Ring Kit, 0.984 x 0.139 09200079 O-ring (3), 09200078 Super O-Lube (1), 09936731 (1) | 09902219 | 09902219 |
| Burner Mixing Chamber Assembly | N3160506 | 00570948 |
| Burner Chamber Holder Assembly | N3160809 | |
| Clamping Ring | | N0401171 |
| Flow Spoiler | 00572561 | 00572561 |
| End Cap O-Ring 0.312 x 0.070 (qty. 4 required) | 09200253 | |
| End Cap Viton O-Ring Standard | 09902147 | 09902147 |
| End Cap O-Ring Organics (Corkprene) | | 00472014 |
| End Cap O-Ring Organics/Aqueous (KALREZ®) | | 09921044 |
| End Cap Assembly (for use with metal body nebulizers) | N3160505 | 00570984 |
| End Cap Assembly (for use with plastic body nebulizers) | N3160511 | N0370392 |
| End Cap Assembly Impact Bead (for use with metal body nebulizers) | N3160546 | |
| Burner Gasket Kit for End Cap Assembly 00570984 00472014 (5), 09902147 (3), 09902219 (1), 09902236 (3), 09902240 (3), 09938527 (1) | | 00470988 |
| Drain Tubing - Tygon Tubing with FEP lining | 02507987 | 02507987 |
| Seal Plug for the (00572615) Pyrex Impact Bead used with (00570984) end cap | | 00572624 |
| O-Ring (1/4 in 6mm i.d.) for seal plug in the end cap 00570984 | | 09902240 |
| O-Ring (1/8 in 3mm i.d.) for seal plug in the end cap 00570984 and N3160545 | 09902236 | 09902236 |
| Burner Drain Assembly for Organic Solutions | N3150232*** | N3150230* |
| Burner Drain Assembly (includes tubing and drain interlock, drain bottle 09904991 not included) | | N2011074* |
| Burner Drain Assembly (includes tubing and drain interlock, drain bottle 09904991 not included) | N0400058*** | N0400058** |
| Burner Head Cleaner | 03031573 | 03031573 |
| Burner Head Adjustment Tool for burner heads with adjustment tool hole | N3161240 | N3161240 |
| Wide Mouth 15L Natural Bottle | 09904991 | 09904991 |
| 10L Wide Mouth Bottle for Organics | 09200122 | 09200122 |

*For AAAnalyst 700/800 **For AAAnalyst 200/400 ***For AAAnalyst 100/200/300/400

AAAnalyst Burner System Components

- A** Burner Head
- B** Burner Mixing Chamber
- C** Clamping Ring
- D** Flow Spoiler
- E** End Cap O-Ring
- F** End Cap Assembly

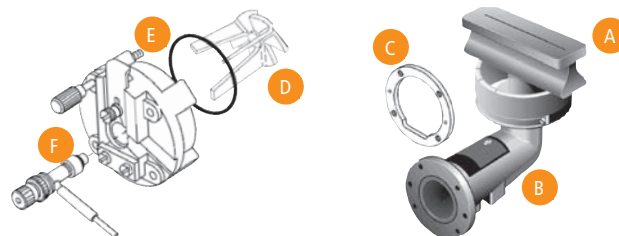

AAAnalyst Burner System Components

WIDE VARIETY OF HIGH PERFORMANCE NEBULIZERS



PinAAcle 900 Removable Burner Assembly allows switching between analytical techniques in a matter of seconds on flame/furnace combination instruments

High-Sensitivity Nebulizer with Pt/Ir Capillary

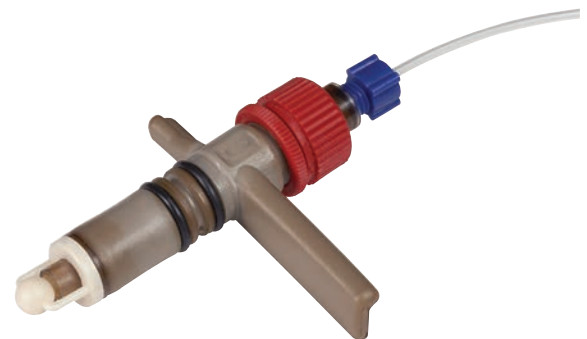

PinAAcle High-Sensitivity Nebulizer Part No. N3160144

THE NEBULIZER IS ONE OF THE MOST IMPORTANT COMPONENTS IN A FLAME AA SPECTROMETER

Sample solutions, with differing physical properties, must be converted into an aerosol of small, similarly-sized droplets. This places great demands on the design of the nebulizer.

All PerkinElmer nebulizer assemblies are adjustable for optimized performance and include easily-interchanged capillary assemblies for simple, reduced-cost maintenance. PerkinElmer nebulizers are manufactured to exacting tolerances to provide maximum sensitivity. Universal, or, "standard" nebulizers are less expensive than the corresponding high-sensitivity nebulizers and provide a lower level of sensitivity. The universal, or, "standard" nebulizers typically provide better precision and reduced "carryover" interference when used with solutions that contain high dissolved solids content of higher analyte concentrations.

HIGH-SENSITIVITY NEBULIZER WITH PT/IR CAPILLARY

Our high-precision nebulizer maximizes stability and sensitivity, even for the toughest matrices. The nebulizer is adjustable so a wide variety of sample matrices — aqueous or organic, acidic or basic, diluted or concentrated — can be analyzed under optimum conditions. This high-sensitivity nebulizer is fabricated with inert plastic materials for maximum performance and corrosion resistance.



High-Sensitivity Nebulizer

- Provides maximum sensitivity, precision and freedom from analytical interferences
- The high-sensitivity nebulizer with platinum/iridium capillary is for most solutions, but not for precious metal samples containing aqua regia
- High-sensitivity nebulizer with tantalum capillary used for solutions containing aqua regia



Metal Body Corrosion-Resistant Nebulizers

- For all solutions containing hydrofluoric acid or aqua regia
- For all solutions containing high concentrations of dissolved solids
- All internal components in contact with solutions are constructed of plastic to resist corrosion from concentrated acids
- Reduced performance compared with stainless steel or platinum/rhodium nebulizers



Metal Body Platinum Alloy Nebulizers

- Recommended for most concentrated acids containing >5% acid
- Includes a platinum alloy needle assembly and a tantalum venturi
- Provides maximum chemical resistance
- Not suitable for use with aqua regia or hydrofluoric acid



Plastic Body GemTip™ Nebulizers

- Corrosion-resistant and can be used to aspirate almost all solutions, even those solutions containing a high percentage of acids
- Designed to obtain optimum sensitivity, detection limits and precision with flame atomic absorption for both air-acetylene and nitrous oxide-acetylene flames



Metal Body Stainless Steel Nebulizers

- For most solutions containing <5% acid, providing exceptional performance and durability
- Excellent performance (precision and signal-to-noise ratio)



NEBULIZER ASSEMBLIES AND SPARES

Plastic Body Nebulizers



| Description | PinAAcle 900 Part No. | AAAnalyst 200/400 Part No. | AAAnalyst 100/300/700/800 Part No. |
|---|-----------------------|----------------------------|------------------------------------|
| High-Sensitivity Nebulizer with Pt/Ir Capillary | | | |
| Nebulizer Assembly | N3160144 | N3150188* | B0505480** |
| Flame Burner Assembly (includes N3160144) | N3160179 | | |
| Impact Bead | B0505086 | B0505086 | B0505086 |
| O-Ring | 09902015 | 09902015 | B0190672 |
| O-Ring | 09926126 | 09926126 | B0506143 |
| O-Ring 9.25 X 1.78 | | | B0174378 |
| Needle Assembly | B3150525 | B3150525 | B0505983 |
| Spring | 09920483 | 09920483 | B0165332 |
| End Cap | N3160511 | N0370392 | N0370392 |
| Spacer | B3150531 | B3150531 | |
| Sample Tube | B3150458 | B3150458 | 09908265 |
| High-Sensitivity Nebulizer with Tantalum Capillary | | | |
| Nebulizer Assembly | | | B0505590 |
| Impact Bead | | | B0505086 |
| O-Ring 1.78 X 1.02 | | | B0190672 |
| O-Ring 4.47 X 1.78 | | | B0506143 |
| O-Ring 9.25 X 1.78 | | | B0174378 |
| Spring | | | B0165332 |
| End Cap | | | N0370392 |
| GemTip™ Nebulizers | | | |
| GemTip Nebulizer Assembly | | | N0370394 |
| High-Sensitivity Nebulizer Assembly | | | N0370393 |
| Impact Bead | | | B0505086 |
| Spring | | | 09902473 |
| End Cap | | | N0370392 |

*May also be used with AAAnalyst 100/300/700/800
 **May also be used with AAAnalyst 200/400



Metal Body Nebulizers

| Description | PinAAcle 900 Part No. | AAAnalyst 200/400 Part No. | AAAnalyst 100/300/700/800 Part No. |
|---|-----------------------|----------------------------|------------------------------------|
| Stainless Steel Nebulizer | | | |
| Nebulizer Assembly (Aqueous) | N3160143 | 03030352 | 03030352 |
| Nebulizer Assembly (Organics) | N3160158 | | |
| Flame Burner Assembly (includes N3160143) | N3160182 | | |
| Impact Bead | 00572615 | 00572615 | 00572615 |
| Capillary Assembly | 03030354 | 03030354 | 03030354 |
| O-Ring Kit (Includes O-Rings in Neb Assembly) | | N9300065 | N9300065 |
| O-Ring 0.176 ID x 0.070 WD | 09902005 | 09902005 | 09902005 |
| O-Ring 0.364 ID x 0.070 WD | 09902015 | | |
| O-Ring 0.208 ID x 0.070 WD | 09902239 | 09902239 | 09902239 |
| Spring | 03031806 | 03031806 | 03031806 |
| End Cap | N3160505 | 00570984 | 00570984 |
| Corrosion-Resistant Nebulizer | | | |
| Nebulizer Assembly | | 03030404 | 03030404 |
| Capillary Assembly | | 03030402 | 03030402 |
| O-Ring Kit (Includes O-Rings in Neb Assembly) | | N9300065 | N9300065 |
| Spring | | 03031806 | 03031806 |
| End Cap | | 00570984 | 00570984 |
| Platinum Alloy Nebulizer | | | |
| Nebulizer Assembly | | 03030299 | 03030299 |
| Capillary Assembly | | 03030433 | 03030433 |
| O-Ring Kit (Includes O-Rings in Neb Assembly) | | N9300065 | N9300065 |
| Spring | | 03031806 | 03031806 |
| End Cap | | 00570984 | 00570984 |



O-Rings for Sampling Accessories

| Description | Kalrez material Organic/Aqueous Part No. | Non-Kalrez material Aqueous Only Part No. |
|--|--|---|
| Nebulizer, End Cap, and Burner Head O-Ring Kit for Plastic Nebulizer for PinAAcle AA. Include: 09200369 (2), 09200276 (2), 09200272 (1) | N3160157 | |
| Nebulizer, End Cap, and Burner Head O-Ring Kit for Stainless Steel Nebulizer for PinAAcle AA. Includes: 09200271 (1), 09200273 (2), 09200274 (1), 09200276 (2) | N3160156 | |
| Nebulizer O-Ring Kit for Stainless Steel Nebulizer for PinAAcle AA. Includes: 09200271 (1), 09200273 (2), 09200274 (1), 09200276 (2) | N3160192 | |
| Nebulizer O-Ring Kit, Stainless Steel: 09200271 (1), 09200273 (2), 09200274 (1) | N2010247 | N2010247 |
| Nebulizer O-Ring Kit for Plastic Nebulizer for PinAAcle AA. Includes: 09200369 (2), 09200276 (2), 09200272 (1) | N3160193 | |
| Nebulizer O-ring Kit for AA200/400. Includes: 09200369 (2), 09200340 (1), 09200276 (2), 09200272 (1) | N2010246 | |
| End Cap O-Ring Kit for PinAAcle AA. Includes: 09200275 (4), 09200277 (1) | N3160194 | |
| End Cap Accessory, O-Ring Kit 09200277 (1), 09200341 (2), 09200342 (2) | N2010245 | N2010245 |
| Metal Body Nebulizer Assembly for PinAAcle (Organics) | N3160158 | N3160143 |
| High Sensitivity Plastic Nebulizer Assembly for PinAAcle (Organics) | N3160159 | N3160144 |
| O-Ring (2) 9.25 X 1.78 MM for (Metal Body/Plastic) Nebulizer Assembly | 09200276 | 09902015 |
| O-Ring (1) 1.80 X 1.00 MM for Metal Body Nebulizer for PinAAcle AA | 09200271 | 09926083 & 09902102 |
| O-Ring (1) 2.00 X 1.00 MM for High sensitivity Plastic Nebulizer Assembly | 09200272 | 09926127 |
| O-Ring (2) 4.47 X 1.78 MM for Metal Body Nebulizer for PinAAcle AA | 09200273 | 09902005 |
| O-Ring (1) 5.28 X 1.78 MM for Metal Body Nebulizer for PinAAcle AA | 09200274 | 09902239 |
| O-Rings (4) 7.65 X 1.78 MM for End Cap Assembly for PinAAcle AA | 09200275 | 09200253 |
| O-Ring (1) 47.29 X 2.62 MM for End Cap Assembly for PinAAcle AA | 09200277 | 09902147 |
| Burner Head O-Ring (1) 24.99 X 3.53 MM for PinAAcle/AAAnalyst AA | 09200278 | 09200079 |
| O-Rings 1.42 x 1.52 mm for High Sensitivity Plastic Nebulizer (Capillary kit) 1.42 x 1.52 mm | 09200369 | |
| O-Ring Viton 4.47 X 1.78 MM for Burner Connector | | 09200360 |

PinAAcle Nebulizers and Assemblies Quick Reference



| Description | Type | Needle | O-Ring Type | Complete Assembly | End Cap Assembly | Replacement Needle Assembly |
|--|---------------------|------------------|-------------|-----------------------|------------------|-----------------------------|
| Plastic High Sensitivity (standard) | Aqueous | Platinum/Iridium | Viton | N3160144 | N3160511 | B3150525 |
| Plastic High Sensitivity | Aqueous or Organics | Platinum/Iridium | Kalrez | N3160159 | N3160189 | N3160154 |
| Plastic High Sensitivity (suitable for aqua regia in addition to organics) | Aqueous or Organics | Tantalum | Kalrez | N3160152 | N3160189 | N3160146 |
| Stainless Steel (standard) | Aqueous | Stainless | Viton | N3160143 | N3160505 | 03030354 |
| Stainless Steel | Aqueous or Organics | Stainless | Kalrez | N3160158 | N3160188 | N3160153 |
| Stainless Steel | Aqueous | Plastic | Viton | | N3160505 | 03030402 |
| Stainless Steel | Aqueous | Platinum Alloy | Viton | | N3160505 | 03030133 |
| Description | Type | | | Burner Drain Assembly | Drain Bottle | |
| Drain Assembly | Aqueous | | | N0400058 | 09904991 | |
| Drain Assembly | Organics | | | N3150232 | 09200122 | |

AA200/400 Nebulizers and Assemblies Quick Reference

| Description | Type | Needle | O-Ring Type | Complete Assembly | End Cap Assembly | Replacement Needle Assembly |
|--|---------------------|----------|-------------|-------------------|------------------|-----------------------------|
| Plastic High Sensitivity (suitable for aqua regia in addition to organics) | Aqueous or Organics | Tantalum | Kalrez | N2010250 | | N3160146 |
| Nebulizer, Plastic | Aqueous or Organics | Tantalum | Kalrez | N2010250 | N2010245 | N3160146 |

Nebulizer Accessories

| Description | Part No. |
|---------------------------------|-----------------|
| Capillary Tubing | 09908265 |
| Nebulizer Cleaning Wires Pkg. 5 | 03030135 |
| Nebulizer Grease | 03030405 |



Nebulizer Capillary Tubing



Nebulizer Cleaning Wires



Nebulizer Grease

AUTOSAMPLER CUPS AND SUPPLIES

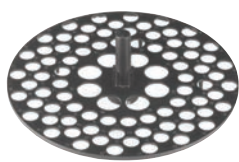

88-Position Tray

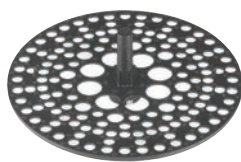

148-Position Tray

Furnace Autosampler Trays

For a quick change to another series of samples, a second sample tray is recommended.

For Model AS-800/AS-900

| Description | Part No. |
|---|-----------------|
| 88-Position Tray, Polypropylene 80 sample locations for 2.0, 2.5 or 3.5 mL sample cups. Each sample tray also has eight positions for 7.0 mL reagent containers. | B3001507 |
| 148-Position Tray, Polypropylene 132 sample locations for 1.2 mL sample cups and eight locations for 2.5 or 3.5 mL sample cups. Each sample tray also has eight positions for 7.0 mL reagent containers. One is provided with the autosampler. | B3001506 |
| Cover | B3001505 |
| Pipette Arm | B3002046 |



Furnace Sampling Probe

Made of PTFE, these are capable of pipetting a variety of corrosive matrices and organic solutions.

Features and Benefits

- Works well with solvent and acid-resistant sampling components
- PTFE pipette tips and capillaries reduce contamination
- Easy replacement

| Description | Part No. |
|--|-----------------|
| For Models AS-60/AS-70/AS-71/AS-72/AS-800/AS-900 | B0129258 |

Reagent Containers

For blank solutions, reagent solutions or matrix modifiers.

| Description | Part No. |
|---|-----------------|
| Round Reagent Containers For Models AS-40/AS-60/AS-70/AS-71/AS-72. 25 mL polypropylene. Suitable for organic solutions. | B0101164 |
| 30 mL Polystyrene – Not for organic solutions. | B0102332 |
| Cloverleaf-shaped Reagent Containers For Models AS-60/AS-70/AS-71/AS-72. 30 mL polypropylene. | B0132799 |



GRAPHITE FURNACE AUTOSAMPLER CUPS

Sample cups are of heavy-duty construction to prevent cracking or tipping. Their conical design allows for use of nearly the entire sample.

Your choice of materials:

- **Polystyrene** – Clear, recommended for use with most aqueous solutions
- **Polyethylene** – Translucent, low-density, recommended for use with most aqueous solutions
- **PTFE** – Recommended for use with most concentrated acids including HF, and for analyses where the lowest detection levels are required
- **Polypropylene** – Translucent; preferred for most solvents

| Volume | Composition | Qty. | Part No. |
|----------|---------------|-------|-----------------|
| 1.2 mL* | Polypropylene | 2,000 | B0510397 |
| 2.0 mL | Polyethylene | 1,000 | B0087056 |
| 2.0 mL | Polystyrene | 1,000 | B0119079 |
| 2.0 mL | PTFE | 30 | B0087600 |
| 2.5 mL | Polypropylene | 1,000 | B3001566 |
| 3.5 mL | Polystyrene | 100 | B0129303 |
| 7.0 mL** | Polypropylene | 100 | B3001567 |

* For use with AS-71/72/800/900 ** For use with AS-800/AS-900

Pliers and Accessories



| Description | Part No. |
|-----------------------------|-----------------|
| For 1.2 mL sample cups. | B0510398 |
| Drain Bottle without Cap 2L | B0104344 |
| Rinse Bottle | B0104281 |

Check Valves

| Description | Aqueous Part No. | Organics Part No. |
|----------------------|------------------|-------------------|
| Check Valve Inlet | B3002007 | B0105973 |
| Check Valve Outlet | B3002006 | B0105974 |
| Inlet and Outlet Kit | B3001485 | |

QUIET, OIL-LESS AND CLEAN

AA ULTRA QUIET OIL-LESS AIR COMPRESSOR

PerkinElmer is expanding its compressor product portfolio to include an industrial grade, quiet, oil-less compressor for dependable and clean air supply. With the addition of a water separator with a 5 micron particle filter, no liquid transfers into the air supply, providing you with contaminant free air. Each quiet, vibration free compressor comes standard with an internally and externally coated air tank with top drain. The AA Ultra Quiet Oil-Less Air Compressor features a low operating sound level of 60 dB and comes completely outfitted to operate the PerkinElmer Atomic Absorption (AA) Spectrometers.



Features and Benefits:

- Completely quiet oil-less operation
- Delivers clean and dry instrument grade air
- Water separator with 5 micron particle filter and auto drain assures no liquid transfer
- Specialty coated cylinders and high temperature piston rings for long service life
- Durable air tank with top drain and internal/external coating
- Low annual operating costs
- A complete compressed air station incorporating an outlet pressure regulator, tank and outlet pressure gauge, shut off ball valve, ASME safety valve, and pressure switch allowing for complete automatic operation



| Specifications | |
|-------------------|-----------------|
| Horse Power | 1 HP |
| Output CFM | 4.2 CFM |
| Output L. | 120 L./min |
| Max Pressure PSI | 120 PSI |
| Max Pressure Bar | 8 bar |
| Max Current 110V | 7.8 Amps |
| Max Current 220V | 3.8 Amps |
| Noise Level | 60 db/A |
| Tank Size Gal. | 6 |
| Tank Size Liters | 24 |
| Dimensions | 16" x 16" x 21" |
| Weight | 53.8 Lbs. |
| Packed Dimensions | 20" x 20" x 25" |
| Packed Weight | 65.8 Lbs. |

| Description | Part No. |
|-------------------------|-----------------|
| Compressor 115V/60Hz | N9306345 |
| Compressor 220V/50-60Hz | N9306346 |

| Description | Part No. |
|-------------------------------|-----------------|
| Replacement Air Intake Filter | N0777870 |
| Micron Dryer Filter Element | N0777871 |

ISO 9001-2008
Certified



ISO 13485-2008
Certified



EXCLUSIVE DESIGN ENSURES EVEN HEATING



NEW!

THGA GRAPHITE TUBES WITH ADVANCED PLATFORM™

The exclusive and patented Advanced Platform design offers an alternative to our Standard Integrated Platform design. With the current Integrated Platform design, the platform attaches to the tube wall along a single side that runs the length of the platform. The new Advanced Platform design suspends the platform in the tube using three small pins in a triangular layout. This has the advantage of minimizing wall contact and reducing thermal conduction from the tube walls resulting in even and rapid heating almost exclusively from thermal radiation, an ideal platform.

Advanced Platform Features:

- Even and rapid heating
- Improved sensitivity for some applications
- Improved batch to batch reliability
- Exclusive and patented design - only from PerkinElmer!

Advanced Platform™ THGA Graphite Tubes **NEW!**

| Description | Advanced Platform Part No. | Advanced Platform w/End Caps Part No. |
|-------------|----------------------------|---------------------------------------|
| 5-pack | N9307830 | N9307832 |
| 20-pack | N9307831 | N9307833 |

STANDARD THGA GRAPHITE TUBES

Today's analysts expect exceptional analytical performance from their graphite furnace atomic absorption spectrometers. That performance must be reproducible from day to day with respect to sensitivity (characteristic mass), accuracy and precision.

The graphite tube, the heart of the graphite furnace, plays a vital role in the overall stability of an analysis. In order to assure stable analytical conditions from one atomization cycle to the next, and from graphite tube to graphite tube, all graphite parts — contacts, tubes and platforms — must be subject to strict quality control by both the instrument manufacturer and the graphite manufacturer.



PerkinElmer's unique, transversely-heated graphite tube includes an integrated platform. The exceptionally uniform temperature distribution obtained with transverse heating significantly reduces or eliminates condensation of the sample matrix components and "memory" effects, and improves the atomization efficiency for refractory elements.

Standard THGA Graphite Tubes

| Description | Part No. |
|-------------|-----------------|
| 5-pack | B3000641 |
| 20-pack | B0504033 |
| 100-pack | N3110147 |

Standard THGA Graphite Tubes with End Caps

For improved characteristic mass with volatile and medium refractory elements such as Ag, As, Cd, Co, Cr, Cu, Pb, Se and Tl, the THGA graphite tubes with end caps are recommended. Note: THGA graphite tubes with end caps are not recommended for refractory elements such as V or Ba.

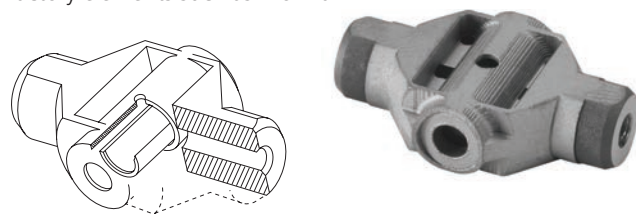

Features and Benefits

- Improved detection limits for volatile and medium refractory elements
- Faster drying for complex matrices due to enlarged dosing hole

Standard THGA Graphite Tubes with End Caps

| Description | Part No. |
|-------------|-----------------|
| 5-pack | B3000653 |
| 20-pack | B3000655 |



UltraClean THGA Graphite Tubes

For the lowest possible detection limits, residual contaminant levels may not be low enough to meet your requirements. For the most demanding analyses, PerkinElmer offers UltraClean THGA graphite tubes — delivering exceptionally low levels of contamination due to advanced high-temperature gas-phase cleaning procedures. UltraClean graphite tubes offer unmatched analytical advantages for special applications such as the determination of extremely low traces of Na, Ca, Fe, Cr and Ni in ultra-clean reagents used in the semiconductor industry, and ultra-trace analyses of environmental, clinical, or food samples.



Features and Benefits

- UltraClean THGA graphite tubes have the lowest possible contamination levels due to extensive high-temperature gas-phase cleaning procedures
- UltraClean THGA graphite tubes are tested and specified for blank levels of Cr, Ni, V, Mo, Ti (<0.003 integrated absorbance units) and Na, Fe, Al, Si, Ca (<0.0005 integrated absorbance units)

UltraClean THGA Graphite Tubes

| Description | Part No. |
|-------------|-----------------|
| 5-pack | B3140361 |
| 20-pack | B3140362 |



THGA Instrument Mirror

Used to optimize drying temperatures and times.



| Description | Part No. |
|------------------------|-----------------|
| THGA Instrument Mirror | B0851900 |

THGA Contact Cylinders

These graphite contact cylinders are engineered for a precise fit so that variations in electrical contact — which might affect the analytical performance — are reduced to a minimum. Contact cylinders with a modified injection port area help to minimize condensation and improve analytical performance with difficult matrices.



Standard THGA Graphite Contact Cylinders

| Description | Part No. |
|-------------|-----------------|
| 1 pair | B0504035 |
| 5 pairs | B0504036 |

Modified THGA Contact Cylinders

| Description | Part No. |
|-------------|-----------------|
| 1 pair | B3002103 |
| 5 pairs | B3002102 |

Accessories and Spare Parts



| Description | Part No. |
|---|-----------------|
| O-Ring (behind Contact Cylinder, front and back) | B0500748 |
| Contact Cylinder Removal Tools | B3120405 |
| THGA Filter Cartridge AA600 Fume Extractor qty. 50. | B0509065 |
| Spare Graphite Tip for fume extraction system | B0506722 |
| Pliers | 09907925 |
| THGA Quartz Window | B0198005 |
| THGA Quartz Window O-Ring | B0501236 |



Matrix Modifiers for Graphite Furnace AA

PerkinElmer provides you with the maximum performance and the lowest possible detection limits

with our high-quality matrix modifiers.

PerkinElmer matrix modifiers thermally stabilize the analyte, allowing higher pyrolysis temperatures to be used, reducing background absorption, and eliminating potential interferences.

Features and Benefits

- High-purity compounds minimize the risk of contamination
- Optimum graphite furnace program can be used due to reduced analyte volatility

Matrix Modifiers

| Modifiers | Concentration | Volume | Part No. |
|--|--|--------|-----------------|
| Mg(NO ₃) ₂ | 1% Mg (as nitrate) | 100 mL | B0190634 |
| Pd | 1% Pd (as nitrate) | 50 mL | B0190635 |
| NH ₄ H ₂ PO ₄ | 10% NH ₄ H ₂ PO ₄ | 100 mL | N9303445 |

MANUFACTURED TO THE HIGHEST QUALITY SPECIFICATIONS

The production of high-quality graphite components requires stringent quality control. To ensure high quality and consistency, a specific grade of high-density base graphite material has been developed for PerkinElmer's exclusive use. This base graphite material is used for the manufacturing of all PerkinElmer graphite tubes.

Selection and careful control of raw materials are extremely important. The composition and the microstructure of the base graphite material determine the specific resistivity of the tube and its heating characteristics.

When you purchase graphite supplies from PerkinElmer, you get the results of our many years of experience with quality graphite parts.

The proper performance, maintenance, and serviceability of our graphite furnace systems can be assured only through the use of genuine PerkinElmer graphite components.

PYROCOATED GRAPHITE TUBES

Grooved Pyrocoated Graphite Tubes

Internally grooved to accept L'vov platforms. Does not include platform.

| Description | Part No. |
|-------------|----------|
| 5-pack | B0137111 |
| 10-pack | B0121092 |
| 20-pack | B3001254 |
| 100-pack | N3110146 |

Pyrocoated Graphite Tubes*

| Description | Part No. |
|---------------------------|----------|
| 5-pack | B0105197 |
| 10-pack | B0135653 |
| 20-pack | B3000342 |
| 20-pack (Forked Platform) | B0505057 |
| 50-pack | B0091504 |

*Not compatible with L'vov platforms

PYROCOATED GRAPHITE TUBES WITH INTEGRATED PLATFORMS

Proven in labs throughout the world, graphite tubes with integrated platforms provide superior performance and are easy to use. Graphite tubes with integrated platforms are machined from one piece of graphite and are totally pyrocoated, providing exceptional tube-to-tube reproducibility. The spherically-shaped platform accommodates up to 50 µL of sample.



Features and Benefits

- Provide STPF conditions for volatile and nonvolatile refractory elements due to the significantly higher heating rates of tube and platform, which can be used for all elements
- Offer an extra measure of convenience versus manually inserting a separate platform
- Provide longer life with many aggressive sample matrices, such as concentrated acids

Pyrocoated Graphite Tubes with Integrated Platforms

| Description | Part No. |
|-------------|----------|
| 5-pack | B3001262 |
| 20-pack | B3001264 |
| 40-pack | N9300651 |

Uncoated Graphite Tubes*

| Description | Part No. |
|-------------|----------|
| 20-pack | B3001253 |
| 50-pack | B0070699 |

*Not compatible with L'vov platforms

NEW! PYROCOATED ADVANCED PLATFORM GRAPHITE TUBES

The exclusive and patented Advanced Platform design offers an alternative to our Standard Integrated Platform design. With the current Integrated Platform design, the platform attaches to the tube wall along a single side that runs the length of the platform. The new Advanced Platform design suspends the platform in the tube using three small pins in a triangular layout. This has the advantage of minimizing

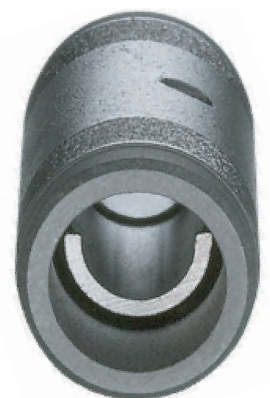

wall contact and reducing thermal conduction from the tube walls resulting in even and rapid heating almost exclusively from thermal radiation, an ideal platform.

Advanced Platform Features:

- Even and rapid heating
- Improved sensitivity for some applications
- Improved batch to batch reliability
- Exclusive and patented design - only from PerkinElmer!

Graphite Tubes with Advanced Platform **NEW!**

| Description | Part No. |
|-------------|-----------------|
| 5-pack | N9307834 |
| 20-pack | N9307835 |

L'VOV PLATFORMS

The L'vov platform is a small plate of solid pyrocoated graphite that is inserted into the graphite tube. It has a slight depression in the center, which can accommodate up to 50 µL of solution. The function of the L'vov platform is to isolate the sample from the tube walls to allow more reproducible atomization of the sample through indirect heating. The platform heats primarily by the radiation given off from the tube walls. Sample vaporization and atomization occur after the tube reaches a steady-state temperature.



Use of the L'vov platform provides:

- Vaporization into a higher temperature gas atmosphere producing more free atoms, which reduce interferences
- Longer tube life because aggressive samples are only in contact with the solid pyrolytic graphite platform

| Description | Part No. |
|-------------|-----------------|
| 20-pack | B3001256 |
| 100-pack | N3110145 |

Pyrocoated Graphite Tube with L'vov Platform

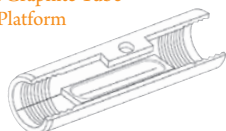

Cross-section of the PerkinElmer HGA graphite tube with manually inserted L'vov platform shown.

Pyrocoated Graphite Tube with Integrated Platforms

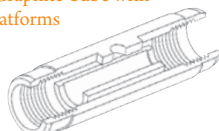

Cross-section of the PerkinElmer HGA graphite tube with integrated platform shown.

CONTACT CYLINDERS

The graphite contact cylinders used in the HGA Graphite Furnace are engineered for a precise fit so that variations in electrical contact — which might affect the analytical performance — are reduced to a minimum. The graphite contacts are shaped so that they completely encase the graphite tube. Thus, the graphite tube is located in a defined inert environment, which ensures uniform heating conditions and long tube lifetime.



Contact Cylinders

For HGA-900/850/800/700/600/300/PinAAcle H Furnaces

- Includes left-hand Contact, right-hand Contact, Shield Ring

| Description | Part No. |
|-------------|-----------------|
| 1 set | B0128495 |
| 5 sets | B3130086 |

HGA Contact Removal Tool

| Description | Part No. |
|---------------------------------|-----------------|
| HGA 900/AA 700/800/PinAAcle 900 | B3121301 |

HGA Instrument Mirror

Used to optimize drying temperatures and times.



| Description | Part No. |
|-----------------------|-----------------|
| HGA Instrument Mirror | B0080259 |

Matrix Modifiers for Graphite Furnace AA

PerkinElmer provides you with the maximum performance and the lowest possible detection limits with our high-quality matrix modifiers.



PerkinElmer matrix modifiers thermally stabilize the analyte, allowing higher pyrolysis temperatures to be used, reducing background absorption, and eliminating potential interferences.

| Modifiers | Concentration | Volume | Part No. |
|--|--|--------|-----------------|
| Mg(NO ₃) ₂ | 1% Mg (as nitrate) | 100 mL | B0190634 |
| Pd | 1% Pd (as nitrate) | 50 mL | B0190635 |
| NH ₄ H ₂ PO ₄ | 10% NH ₄ H ₂ PO ₄ | 100 mL | N9303445 |



AA GRAPHITE FOR NON-PERKINELMER INSTRUMENTS

PerkinElmer supplies a wide range of graphite tubes for non-PerkinElmer instrumentation. Graphite tubes are made with the highest quality material guaranteed to work for your AA instrument.

Use the convenient tables below to identify the compatible graphite furnace tube for your AA instrument.

GBC Instruments

| Description | Qty/pack | GBC Part No. | Part No. |
|--|----------|--------------|----------|
| Standard tube, pyrolytically coated | 10 | 99-0059-00 | N9304600 |
| Platform, pyrolytically coated | 10 | 99-0060-00 | N9304601 |
| Standard tube, coated, with Omega-platform | 10 | 99-0342-00 | N9304602 |
| Electrode contacts | 2 | 99-0061-00 | N9304603 |
| Shroud | 1 | 45-0004-00 | N9304604 |

Hitachi® Instruments

| Description | Qty/pack | Hitachi® Part No. | Part No. |
|--|----------|-------------------|----------|
| Standard tube, pyrolytically coated | 10 | 180-7444 | N9304600 |
| Standard tube, uncoated | 10 | 180-7400 | N9304601 |
| Standard platform, pyrolytically coated | 10 | 180-7404 | N9304602 |
| Tube for extended injection volume, pyrolytically coated | 10 | 190-6003 | N9304603 |
| Contacts, AD 20 mm | 2 | 180-7401 | N9304604 |
| Zeeman contacts, AD 18 mm | 2 | 172-8805 | N9304610 |
| Omega Tube | 10 | N/A | N9304611 |

Shimadzu® Instruments

| Description | Qty/pack | Shimadzu® Part No. | Part No. |
|--|----------|--------------------|----------|
| Standard tube, pyrolytically coated (90° contact cone) | 10 | 206-50588 | N9304612 |
| Standard tube, uncoated (90° contact cone) | 10 | 206-50587 | N9304613 |
| Tube with built-in platform, coated (90° contact cone) | 10 | 206-5887-02RI | N9304614 |
| Left Electrode with housing (90° cone) | 1 | 206-50602 | N9304615 |
| Right Electrode (90° cone) | 1 | 206-50603 | N9304616 |

Thermo® Instruments

| Description | Qty/pack | Thermo® Part No. | Part No. |
|--|----------|------------------|----------|
| Partridge tube, uncoated | 10 | 9423 393 95031 | N9304617 |
| Partridge tube, coated | 10 | 9423 393 95071 | N9304618 |
| Partridge tube, coated (extended lifetime) | 10 | 9423 393 95041 | N9304619 |
| Zeeman Electrode Contact | 2 | 9423 393 95161 | N9304620 |
| Standard Electrode Contact | 2 | 9423 393 95011 | N9304621 |
| Omega Tube | 10 | 9423 490 20101 | N9304622 |

Agilent® Instruments

| Description | Qty/pack | Agilent Part No. | Part No. |
|--|----------|------------------|----------|
| Plateau tube, pyrolytically coated | 10 | 63-100011-00 | N9304623 |
| Bone platform, pyrolytically coated (for use in plateau tubes) | 10 | 63-100013-00 | N9304624 |
| Partition tube, pyrolytically coated | 10 | 63-100012-00 | N9304625 |
| Partition tube, uncoated | 10 | 63-100015-00 | N9304626 |
| Partition tube, pyrolytically coated extended life | 10 | 63-100012-EL | N9304627 |
| Omega-platform tube | 10 | 63-100037-00 | N9304628 |
| Shroud | 1 | 63-100018-00 | N9304629 |
| Electrode | 2 | 63-100016-00 | N9304630 |
| Zeeman Shroud | 1 | 63-100019-00 | N9304631 |
| Zeeman Electrode (Older Instruments) | 2 | 63-100017-00 | N9304632 |
| Zeeman Electrode (Newer Instruments) | 2 | 63-100035-00 | N9304633 |
| Zeeman Shroud GTA120, pyrocoated | 1 | 63-100036-00 | N9304634 |

See Atomax 1.5" hollow cathode lamps for non-PerkinElmer instruments on page 19.



SMS 100 Consumables and Supplies

| Description | Part No. |
|---|----------|
| Nickel Boats (Qty. 42) | N9309017 |
| Quartz Combustion Boats (Qty. 10) | N9309032 |
| Replacement Carbon 500 g | N9309035 |
| Catalyst Tube (Packed) | N9309036 |
| Autosampler Boat Shuttle | N9309019 |
| Exhaust Tubing Assembly | N9309006 |
| Amalgamator Tube | N9309007 |
| Mercury Lamp | N9309010 |
| Hg Vapor Trap Kit with Carbon Material | N9309011 |
| Nafion® Drying Tube | N9309021 |
| Sample Substrate 250 mL | N9309103 |
| Oxygen Two Stage Regulator | N9309004 |
| Oxygen, Nitrogen, Argon Supply | N9309009 |
| Autosampler Boat Shuttle | N9309019 |
| UV Windows ½ d x ¼ t 10–20 w (Qty. 2) | N9309024 |
| O-Ring ¼ i.d. x ¼ w Viton | N9309025 |
| O-Ring Amalgamator ¼ i.d., ¾ o.d. Viton | N9309026 |
| O-Ring Injector ⅝ i.d., o.d. ¾ | N9309027 |
| O-Ring Catalyst Front Viton | N9309028 |
| O-Ring .414D Catalyst Rear | N9309030 |
| O-Ring Kit for SMS 100 | N9309029 |
| High Sensitivity Absorption Cell 5 inch | N9309033 |
| Low Sensitivity Absorption Cell 1 inch | N9309034 |



PerkinElmer SMS 100 Mercury Analyzer

The SMS 100 is a dedicated mercury analyzer for the determination of total mercury in solid and liquid samples using the principle of thermal decomposition, amalgamation and atomic absorption described in U.S. EPA Method 7473.

The SMS 100 uses a decomposition furnace to release mercury vapor instead of the chemical reduction step used in traditional liquid-based analyzers. Both solid and liquid matrices can be loaded onto the instrument's autosampler and analyzed without acid digestion or sample preparation prior to analysis. Some of the many sample matrices applicable to SMS 100 technology include sludges, sediments, soils, wastewaters, effluents, coal, fly ash, minerals, ores, fertilizers, various foodstuffs, blood, urine and hair.



Amalgamator Tube



Catalyst Tube



Nickel Boat

Spares Kits

| Description | Qty | Part No. |
|-------------------------|-----|----------|
| Basic Spares Kit | | N9309109 |
| Kit Includes: | | |
| Amalgamator Tube | 1 | N9309007 |
| Mercury Source Lamp | 1 | N9309010 |
| Nafion® Drying Tube | 1 | N9309021 |
| O-Ring Kit | 1 | N9309029 |

| Description | Qty | Part No. |
|----------------------------------|-----|----------|
| Extended Spares Parts Kit | | N9309110 |
| Kit Includes: | | |
| Amalgamator Tube | 2 | N9309007 |
| Sample Gas Tubing Assembly | 1 | N9309008 |
| Mercury Source Lamp | 1 | N9309010 |
| Injector Fork Assembly | 1 | N9309012 |
| CVAAS Tubing Kit | 1 | N9309013 |
| Amalgamator Heater Coil | 1 | N9309066 |
| 6 g Krytox® Tube Grease | 1 | N9309108 |
| Nafion® Drying Tube | 1 | N9309021 |
| Quartz Windows | 6 | N9309024 |
| O-Ring Kits | 2 | N9309029 |
| Window End Caps | 8 | N9309031 |
| 5 inch Optical Cells | 2 | N9309033 |
| 1 inch Optical Cell | 1 | N9309034 |



MEINHARD® NEBULIZERS

The MEINHARD® concentric glass nebulizers reflect exacting standards in design and manufacturing. They provide excellent sensitivity and precision for aqueous solutions and samples with few dissolved solids (less than 1%). Meinhard nebulizers for Optima include Standard Nebulizer Solution Fitting, 0.5 mm PTFE (N0777414) and PFA Gas Quick Connect (N8121036).



Nebulizer Solution Fitting (N0777414)



Nebulizer Clip (N0777460)



PFA Gas Quick Connect (N8121036)

For Optima 2x00/3x00/4x00/5x00/7x00/8x00

| Type | Ar Flow Rate | Uptake Rate | Part No. |
|---|--------------|-------------|-----------------|
| Type A3 | 1 L/min | 3 mL/min | 00472020 |
| Type C1** | 1 L/min | 1 mL/min | 00472022 |
| Type K3 | 0.7 L/min | 3 mL/min | N0681574 |
| Type K1* | 1 L/min | 1 mL/min | N0777707 |
| Standard nebulizer solution fitting, 0.5 mm PTFE. 0.5mm x 70 cm capillary | | | N0777414 |
| Nebulizer Clip for Meinhard Nebulizers, Qty. 1 | | | N0777460 |
| PFA Gas Quick Connect | | | N8121036 |

*Standard with Optima 8x00 instrument.

**Standard for Optima 2x00/4x00/5x00/7x00 Instrument



End Cap for Concentric Nebulizers

End cap to fit any concentric nebulizer onto a Scott Spray Chamber.

| ICP Model | Part No. |
|--------------------------------------|-----------------|
| Optima 2x00/3x00/4x00/5x00/7x00/8x00 | N0680504 |



MIRA MIST® NEBULIZERS

For Optima 2x00/3x00/4x00/5x00/7x00/8x00

| Description | Uptake Rate | Part No. |
|---|---------------------|-----------------|
| PEEK Mira Mist Excellent mist, and can handle high level of particulates in sample. | 0.2 to 2.5 mL/min | N0775330 |
| PTFE Mira Mist For samples with high HF, Sulphuric, and some other solvents that attack Peek. | 0.2 to 2.5 mL/min | N0777031 |
| Ari Mist Very Low Sample Flow | 0.050 to 1.0 mL/min | N0777032 |
| T2100 For high levels of undissolved solids such as oil samples, geologic samples, and slurries. | 0.5 to 3.0 mL/min | N0777033 |

CONCENTRIC NEBULIZERS FOR A WIDE VARIETY OF APPLICATIONS



Shown with UniFit Connector

MICROMIST™ NEBULIZERS

The MicroMist micro-uptake glass concentric nebulizer offers high performance for limited sample volumes. MicroMists with sample uptakes 0.2 – 0.6 mL/min are fitted with a UniFit connector with 1.3 mm o.d. x 0.50 mm i.d. x 700 mm long sample tubing (N0777513). MicroMists with sample uptakes 0.05 – 0.1 mL/min are fitted a UniFit connector with 1.3 mm o.d. x 0.25 mm i.d. x 700 mm long sample tubing (N0777514). EzyLok Connector Kit (N0777413) included. Material: Borosilicate glass.

For Optima 2x00/3x00 XL/3x00 DV/3000 SCX/4x00/5x00/7x00/8x00

| Ar Flow Rate | Uptake Rate | Part No. |
|--------------|-------------|-----------------|
| 0.7 L/min | 0.05 mL/min | N0775349 |
| 0.7 L/min | 0.1 mL/min | N0775348 |
| 0.7 L/min | 0.2 mL/min | N0775347 |
| 0.7 L/min | 0.6 mL/min | N0775346 |



Mira Mist Spares

| Description | Pkg. | Part No. |
|---|------|-----------------|
| 0.5 meters 0.44" OD x .018" ID | 1 | N0777111 |
| 0.5 meters 0.44" OD x .018" ID | 10 | N0777112 |
| 2 mm gas line with upchurch fittings | 1 | N0777113 |
| Mira Mist Quick Release | 1 | N0777114 |
| 1/4" Adapter | 1 | N0777115 |
| 0.44" OD x .018" ID polyethylene tubing 3M | 1 | N0777116 |
| 0.44" OD x .018" ID polyethylene tubing 30M | 1 | N0777117 |

SEASPRAY™ NEBULIZERS

The SeaSpray concentric nebulizer is ideal for samples with high dissolved solids and offers outstanding nebulization efficiency for trace level analyses. It offers freedom from clogging while nebulizing solutions to the limit of solubility of most mineral salts and conferring significant sensitivity gains. Includes UniFit Connector with 0.75 mm ID x 1.3mm OD x 700 mm long tubing (N0777512) and EzyLok Connector Kit (N0777413). Material: Borosilicate glass.



For Optima 2x00/3x00 XL/3x00 DV/3000SCX/4x00/5x00/7x00/8x00

| Ar Flow Rate | Uptake Rate | Part No. |
|--------------|-------------|-----------------|
| 0.7 L/min | 2 mL/min | N0775345 |

For Optima 3000/3000 SCR/3x00 RL

| Ar Flow Rate | Uptake Rate | Part No. |
|--------------|-------------|-----------------|
| 1.0 L/min | 2 mL/min | N0775340 |

Conikal™ Nebulizer

Ideal for samples containing only moderate concentrations of dissolved salts, no particulates, and no hydrofluoric acid. Material: Borosilicate glass.



For Optima 2x00/3x00 XL/3x00 DV/3000SCX/4x00/5x00/7x00/8x00

| Uptake Rate | Part No. |
|-------------|-----------------|
| 2 mL/min | N0777487 |

Slurry™ Nebulizer

Ideal for the analysis of used engine oils for wear metals. A sample which consists of small particulates in liquid matrix is a slurry and is suited to this nebulizer. Material: Borosilicate glass.



For Optima 2x00/3x00 XL/3x00 DV/3000SCX/4x00/5x00/7x00/8x00

| Uptake Rate | Part No. |
|-------------|-----------------|
| 4 mL/min | N0777488 |

Ceramic VeeSpray™ Nebulizer

The Ceramic VeeSpray nebulizer is made from alumina ceramic, making it ideal for HF analyses. It provides reproducible performance when working with samples containing large particulates. Material: 99.8% Alumina Ceramic.



For Optima 2x00/3x00 XL/3x00 DV/3000SCX/4x00/5x00/7x00/8x00

| Uptake Rate | Part No. |
|------------------|-----------------|
| 0.6 - 3.0 mL/min | N0777489 |

PolyCon™ Nebulizer

For routine high precision analyses involving samples digested in HF and are not high in dissolved solids. Material: HF Resistant Polyimide.



For Optima 2x00/3x00 XL/3x00 DV/3000SCX/4x00/5x00/7x00/8x00

| Uptake Rate | Part No. |
|-------------|-----------------|
| 2 mL/min | N0777490 |

DuraMist™ Nebulizer

The DuraMist is an economical nebulizer for high precision analyses involving samples digested in HF. Recommended for samples containing up to 5% HF. For samples with higher concentrations of HF, the OpalMist PFA nebulizer is recommended. Material: HF Resistant PEEK



For Optima 2x00/3x00 XL/3x00 DV/3000SCX/4x00/5x00/7x00/8x00

| Ar Flow Rate | Uptake Rate | Part No. |
|--------------|-------------|-----------------|
| 0.7L/min | 0.4 mL/min | N0777713 |
| 0.7L/min | 1.0 mL/min | N0777714 |

OpalMist™ Nebulizer

For high precision analyses requiring the highest chemical resistancy of HF, alkalis and organics. The OpalMist is capable of aspirating high concentrations of dissolved solids without clogging. An ideal nebulizer to handle geochemical samples which are typically dissolved in HF and are high in dissolved solids. Material: PFA.



For Optima 2x00/3x00 XL/3x00 DV/3000SCX/4x00/5x00/7x00/8x00

| AR Flow Rate | Uptake Rate | Part No. |
|--------------|-------------|-----------------|
| 0.7 L/min | 0.6 mL/min | N0777735 |
| 0.7 L/min | 0.05 mL/min | N0777738 |
| 0.7 L/min | 0.1 mL/min | N0777737 |
| 0.7 L/min | 0.2 mL/min | N0777736 |
| 0.7 L/min | 2 mL/min | N0777734 |



The Eluo™ Nebulizer Cleaner

The Eluo is designated to efficiently deliver a cleanser through the nebulizer capillary to dislodge particle build-up and thoroughly clean the nebulizer. One simple action does it all. No more messy procedures, waiting overnight or shattered nebulizers in ultrasonic baths.

| Description | Part No. |
|--|-----------------|
| For Newer OpalMist, PolyCon, DuraMist, Meinhard, other Glass Nebulizers. | N0777712 |
| For OLD style OpalMist or PolyCon Nebulizers | N0775358 |

Connectors for MicroMist and SeaSpray Nebulizers



| Description | Pkg. | Part No. |
|--|------|-----------------|
| UniFit | | |
| 0.25 mm ID x 1.3 mm OD x 700 mm long | 10 | N0777514 |
| 0.50 mm ID x 1.3 mm OD x 700 mm long | 10 | N0777513 |
| 0.75 mm ID x 1.3 mm OD x 700 mm long | 10 | N0777512 |
| 1.30 mm OD X 0.75 mm ID x 700 mm long | 3 | N0774077 |
| 1/16 inch OD x 0.25 mm ID x 700 mm | 10 | N0777845 |
| 1/16 inch OD x 0.50 mm ID x 700 mm | 10 | N0777846 |
| 1/16 inch OD x 0.75 mm ID x 700 mm | 10 | N0777847 |
| 1/16 inch OD X 0.75 mm ID x 700 mm long | 3 | N0774080 |
| UniFit-EzyFit Sample Tube | 6 | N0777061 |
| EzyFit | | |
| 0.25 mm ID x 1.27 mm OD x 700 mm long | 10 | N0777437 |
| 0.50 mm ID x 1.27 mm OD x 700 mm long | 10 | N0777436 |
| 0.75 mm ID x 1.27 mm OD x 700 mm long | 10 | N0777435 |
| 0.25 mm ID x 1/16" OD x 700 mm long | 10 | N0777464 |
| 0.50 mm ID x 1/16" OD x 700 mm long | 10 | N0777463 |
| 0.50 mm ID x 1/16" OD x 700 mm long Twin | 6 | N0777462 |
| UniFit-EzyFit Sample Tube | 6 | N0777061 |

EzyLok Kit for Nebulizer Gas Side Arm



| Description | Part No. |
|--|-----------------|
| EzyLok Kit - Includes: EzyLok Connector for 4mm Tubing, EzyLok 6mm Hose Adaptor, Nebulizer Hose Clip | N0777413 |



| Description | Part No. |
|--|-----------------|
| Nebulizer Pressure Hose Clips (standard) | N0773197 |
| Nebulizer Clip for Meinhard Nebulizers | N0777460 |

PFA Nebulizer Obstruction Removal Kit



While naturally resistant to obstructions, PFA nebulizers may occasionally require maintenance. Use this kit to safely remove obstructions in all PFA-ST nebulizers for long-term high performance.

| Description | Part No. |
|-----------------------------------|-----------------|
| Nebulizer Obstruction Removal Kit | N8145236 |

HIGH EFFICIENCY MICROFLOW NEBULIZERS

MicroFlow nebulizers are resistant to clogging, reliably self-aspirated or pumped to produce a fine aerosol for high transport efficiency and high sensitivity.

PFA-ST Nebulizer

The PFA-ST MicroFlow nebulizer is made from high purity, HF resistant PFA. It has an exchangeable external sample uptake capillary. The sample uptake rate is controlled by the diameter of the external capillary or probe.



Features:

- Chemically resistant—ideal for strong acids, alkalis and organics
- Can be pumped from < 0.1 mL/min to 3.0 mL/min
- Direct analysis of volatile and non-volatile organic solvents

| Description | Part No. |
|------------------|-----------------|
| PFA-ST Nebulizer | N0777049 |

PolyPro-ST Nebulizer

The PolyPro-ST Nebulizer is an HF resistant alternative to the PFA nebulizers but has the same high efficiency aerosol generation. It is a robust nebulizer that can self aspirate with an exchangeable external sample uptake capillary or be used with a peristaltic pump.



| Description | Part No. |
|----------------------|-----------------|
| PolyPro-ST Nebulizer | N0777219 |

PFA-ST3 Nebulizer

The PFA-ST3 Nebulizer is designed for superior clog resistance and higher sensitivity compared to the standard PFA nebulizer.



| Description | Part No. |
|-------------------|-----------------|
| PFA-ST3 Nebulizer | N0777676 |

Sample Capillaries for ST Nebulizers

| I.D. | Self-aspiration rate I.D. (@1L/m Ar) | Part No. |
|---------|--------------------------------------|-----------------|
| 0.15 mm | 20 µL/min (red) | N8122382 |
| 0.2 mm | 50 µL/min (purple) | N8145135 |
| 0.25 mm | 100 µL/min (green) | N8122383 |
| 0.3 mm | 200 µL/min (yellow) | N8145136 |
| 0.5 mm | 400 µL/min (orange) | N8122384 |
| 0.8 mm | 700 µL/min (blue) | N8145137 |
| 1.0 mm | 1 mL/min (gray) | N8145138 |



GemCone™ Low-Flow Nebulizers

Low-flow GemCones permit lower nebulizer gas flow rates, useful for spectral lines with high excitation energies and for providing a more robust plasma. GemCone Nebulizers require an end cap for use with Scott Spray Chambers.

| ICP Model | Part No. |
|--------------------------|-----------------|
| 2x00/4x00/5x00/7x00/8x00 | N0770358 |



GemCone High Dissolved Solids Nebulizer

High solids GemCones are for samples with high dissolved solids (up to 20%). This conespray nebulizer allows you to analyze samples with higher solids concentration than is possible with a

Cross-Flow nebulizer. GemCone nebulizers require an end cap for use with Scott Spray Chambers.

| Description | Part No. |
|---|-----------------|
| GemCone High Dissolved Solids Nebulizer | N0690670 |



GemCone Nebulizer Accessories

| Description | Part No. |
|---|-----------------|
| GemCone Sample Capillary Adapter | N0371505 |
| End Cap for GemCone Nebulizers | N0680504 |
| Quick Disconnect Tubing with Swagelock | N0770336 |
| Quick Disconnect Tubing without Swagelock | N0770610 |
| Capillary Tubing (10 ft.) | 09908265 |
| PTFE Capillary Tubing (1 FT.) | 09985708 |

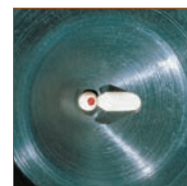

GemTip Cross-Flow II Nebulizers

Excellent general purpose nebulizer for the analysis of strong mineral acids (including HF) and samples with less than 5% dissolved solids. It can routinely handle 50% (v/v) solutions of HCl, HNO₃, H₂SO₄, H₂PO₄, 20% (v/v) HF and 30% (v/v) NaOH. Up to 20% NaCl can be aspirated by the nebulizer for 1 hour without clogging. Uses chemically resistant GemTips made of sapphire and ruby in a chemically resistant end cap.

| ICP Model | Part No. |
|---------------------|-----------------|
| 8x00 | N0780546 |
| 2x00/4x00/5x00/7x00 | N0770546 |

GemTip Cross-Flow II Nebulizer Tip Kits

The Tip Kit includes a clear sapphire sample tip and a red ruby argon tip. The tips are constructed of PEEK with the gem inserts noted for maximum corrosion resistance.



| ICP Model | Part No. |
|----------------------------------|-----------------|
| 8x00 | N0780676 |
| 2x00/4x00/5x00/7x00 | N0690676 |
| O-Ring for GemTip II Tips qty. 1 | 09921045 |

Argon Humidifier with Bypass

The Argon Humidifier is commonly used in ICP analyses of samples with very high dissolved solids concentration. Helping to prevent salt build-up inside the sample introduction system, the Argon Humidifier allows uninterrupted and maintenance-free operation. The Argon Humidifier combines ease of operation, high performance and safety.



| ICP Model | Part No. |
|---------------------------------|-----------------|
| Optima 2x00/4x00/5x00/7x00/8x00 | N0775331 |



Standard Cyclonic
Spray Chamber
Part No. N0776052



Cyclonic
O-Ring Free
Part No. N0775351



Cinnabar Spray
Chamber
Part No. N0777494

Cyclonic Spray Chambers

The spray chamber is an integral part of the sample introduction system responsible for filtering the sample mist to permit the appropriate droplet size distribution to reach the plasma.

Save Time and Expense

- Decreased sample introduction system installation and optimization time due to the preset nature of the spray chamber/nebulizer combination
- More samples per hour due to minimal dead volume and efficient draining

Unique Design Characteristics

- The nebulizer port is oversized so that sample solution cannot build up around the nebulizer as it will in other cyclonic designs. This translates to less carryover, faster washout times and greater productivity from your Optima
- Each spray chamber incorporates a precisely-machined ridge along the inside top of the spray chamber. Both the angle and depth of the ridge are critical to performance. The result is efficient draining of sample waste and the elimination of large droplets being swept into the plasma. This eliminates the periodic “spiking” that adversely affects precision and fosters faster washout times

Standard and O-Ring Free glass cyclonic spray chambers can be used with either GemCone or concentric glass nebulizers. HF resistant cyclonic spray chambers should be used with GemCone, SeaSpray or MicroMist nebulizers.

| ICP Model | Type | Part No. |
|--------------------------|-------------------------------------|-----------------|
| 2x00/4x00/5x00/7x00/8x00 | Standard* | N0776052 |
| 2x00/4x00/5x00/7x00/8x00 | O-Ring Free | N0775351 |
| 2x00/4x00/5x00/7x00/8x00 | O-Ring Free with Easy-Seal Threaded | N0772017 |

*Standard Cyclonic Spray Chamber (N0776052) with Adapter (N0770614); Spray Chamber Kit with Mount Part No. N0770605

See Sample Introduction Kits for complete spares kits.

MAXIMUM SENSITIVITY AND EFFICIENCY

Cinnabar™ 20mL Glass Cyclonic Spray Chamber

The Cinnabar spray chamber is a mini-cyclonic spray chamber which gives good sensitivity at very low uptakes. The Cinnabar's design and low volume is ideal for the reduction of memory and matrix effects and very fast washout. Volume 20 mL.

| ICP Model | Type | Part No. |
|--------------------------|-------------|-----------------|
| 2x00/4x00/5x00/7x00/8x00 | O-Ring Free | N0777494 |



Part No. N0770600 Part No. N0770614

Accessories and Drain Parts

| Description. | Part No. |
|--|-----------------|
| Cyclonic Spray Chamber Adapter | N0770614 |
| Mounting Block only | N0770600 |
| Drain Adapter Assembly for Scott Spray Chamber Includes the spray chamber fitting and tubing to pump out the waste solution from the spray chamber (does not include the peristaltic pump tubing) | N0770613 |
| Carboy, 15 L | 09904991 |
| Drain Cap Assembly | N0690271 |



Part No. N0777439

Part No. N0777438

Connectors and Spares

| Description | Pkg. | Part No. |
|---|------|-----------------|
| EzyLok Connector for Jacketed Spray Chamber | 4 | N0774101 |
| Helix Locking Screw | 1 | N0777438 |
| Helix Seal | 4 | N0777439 |
| Nebulizer Adaptor Plug 16/6 for N0776052 Spray Chamber | | N0776006 |
| O-Ring Set for Nebulizer Adaptor Plug 16/6 | | N0776007 |
| O-ring kit for Tracey TFE Spray Chamber (N0777496) with Helix | | N0777844 |

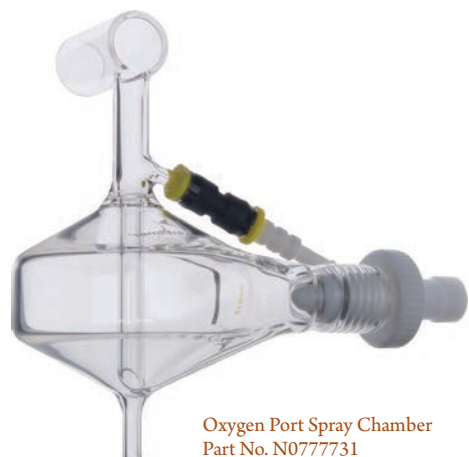

Oxygen Port Spray Chamber
Part No. N077731

HF Spray Chamber
Part No.
N0777497



HF Spray Chamber
Part No.
N0777496



Baffled Cyclonic Spray Chambers

The Baffled Cyclonic Spray Chamber features a central transfer tube which acts as a secondary particle separator, helping to separate larger aerosol particles from the sample. This reduces solvent load in the plasma without compromising detection limits.

Features and Benefits

- The distance between the bottom of the baffle and the chamber wall is carefully controlled so that droplets cannot form on the bottom of the baffle. The advantage is smooth draining and improved precision
- The baffle is cut at a sharp angle so that a large cross-section of the spray chamber is sampled as opposed to a straight cut which would have a very small sampling cross-section. The advantage is more representative sampling and reduced matrix effect

| ICP Model | Type | Part No. |
|---|-------------|-----------------|
| 2x00/4x00/5x00/7x00 DV/8x00 | Standard | N0776053 |
| 2x00/4x00/5x00/7x00 DV/8x00 | O-Ring Free | N0775352 |
| 2x00/4x00/5x00/7x00 DV/8x00 20mL | O-Ring Free | N0777495 |
| 2x00/4x00/5x00/7x00 DV/8x00 for Oil Analysis (4 mm baffle) | Standard | N0776090 |
| 2x00/4x00/5x00/7x00 DV/8x00 for Oil Analysis (4 mm baffle) | O-Ring Free | N0775355 |
| 2x00/4x00/5x00/7x00 DV/8x00 for Oil Analysis (4 mm baffle) with Oxygen Port | O-Ring Free | N0777731 |
| 4300V/5300V/7300V | Standard | N0771501 |
| 4300V/5300V/7300V | O-Ring Free | N0775356 |

HF Resistant Spray Chambers

| ICP Model | Type | Part No. |
|---|-------------|-----------------|
| 4300/5300/7300V TFE PTFE, 50mL | O-Ring Free | N0777497 |
| 2x00/4x00/5x00/7x00 DV/8x00 TFE PTFE, 50mL | O-Ring Free | N0777496 |
| O-ring kit for N0777496 Spray Chamber | | N0777844 |



Scott Spray Chamber
Part No. N0770357

Scott Spray Chambers

The Scott Spray Chamber is made from corrosion-resistant material, which is inert to most mineral acids including HF, aqua regia and all organic solvents normally used in ICP analyses. The Scott-type design minimizes pulsations from the peristaltic pump. The Type II, two-piece design ensures leak-free performance. The removable inner tube allows the chamber to be easily disassembled for cleaning.

| ICP Model | Part No. |
|--------------------------|-----------------|
| 2x00/4x00/5x00/7x00/8x00 | N0770357 |
| 3000/3000 SCR/3x00 RL | N0690640 |
| 3x00 DV/XL/3000 SCX | N0690720 |

See Sample Introduction Kits for complete spares kits.

Metal Ball Joint Clip



Used to connect spray chamber and torch. Includes tension screw for 4300V/5300V/7300V instrument.

| Description | Part No. |
|-----------------------|-----------------|
| Metal Ball Joint Clip | N0773114 |



Quick-Change Torch Module with Cyclonic Spray Chamber and Concentric Nebulizer

Complete torch and sample introduction module including complete Single-Slot Demountable Torch, mounting block, 2 mm Alumina Injector, Cyclonic Spray Chamber and MEINHARD® Concentric Nebulizer.

| ICP Model | Part No. |
|---------------------|-----------------|
| 8x00 | N0780607 |
| 2x00/4x00/5x00/7x00 | N0770607 |

Mounting Block

Mounting block only. Does not include torch, injector, spray chamber or nebulizer.



| ICP Model | Part No. |
|---------------------------------|-----------------|
| Optima 2x00/4x00/5x00/7x00/8x00 | N0770600 |

Quick-Change Torch Module for HF Analysis

| Description | ICP Model | Part No. |
|---|--------------------------|-----------------|
| HF-Resistant Analysis Includes GemCone High Dissolved Solids Nebulizer, Alumina 2.0 mm Injector, Quartz 3-Slot Torch, HF-Resistant Baffled Cyclonic Spray Chamber | Optima 4300V/5300V/7300V | N0770911 |

Quick-Change Torch Module for Oil Analysis

| Description | ICP Model | Part No. |
|--|--------------------------|-----------------|
| Used Oil Analysis Includes GemCone Nebulizer, Alumina 1.2 mm Injector, Quartz 3-Slot Torch, Baffled Cyclonic Spray Chamber | Optima 4300V/5300V/7300V | N0770910 |

QUICK-CHANGE FOR MAXIMUM EFFICIENCY



Quick-Change Torch Module with Scott Spray Chamber and GemTip Cross-Flow II Nebulizer

Complete torch and sample introduction module including Demountable Single-Slot Torch, mounting block, 2 mm Alumina Injector, Scott Spray Chamber and GemTip Cross-Flow II Nebulizer. Useful when a separate sample introduction is required for running different sample types.

| ICP Model | Part No. |
|------------------------|-----------------|
| 8x00 | N0780606 |
| 2x00/4x00/5x00/7x00 DV | N0770606 |
| 3000/3000 SCR/3x00 RL | N0690610 |
| 3x00 DV | N0690812 |
| 3x00 XL/3000 SCX | N0690712 |

Quick-Change Torch Module Support Stand

A free-standing support stand to hold your spare Quick-Change Torch Module or as a means of conveniently holding your module when working inside the sample compartment.



| ICP Model | Part No. |
|-----------------------------|-----------------|
| 2x00/4x00/5x00/7x00 DV/8x00 | N0770609 |

OPTIMA™ ICP-OES SAMPLE INTRODUCTION KITS



| Description | Part No. |
|---|-----------------|
| Cyclonic/Concentric Kit 8x00 | N0780617 |
| 1 Slot Quartz Torch | N0780130 |
| 2.0 mm i.d. Alumina Injector | N0781014 |
| Glass Cyclonic Spray Chamber | N0776052 |
| Meinhard® Type K1 Nebulizer | N0777707 |
| Quartz Torch Copper Ignitor Tape – Qty. 50 pcs. | N0781097 |

| Description | Part No. |
|---|-----------------|
| Cyclonic/Concentric Kit 2x00/4x00/5x00/7x00 DV | N0770730 |
| 1 Slot Quartz Torch | N0770338 |
| Quartz Bonnet | N0775289 |
| 2.0 mm i.d. Alumina Injector | N0775177 |
| Glass Cyclonic Spray Chamber | N0776052 |
| Meinhard® Type C High Dissolved Solids Nebulizer | 00472022 |
| Quartz Torch Copper Ignitor Tape – Qty. 120 pcs. | N0775297 |



| Description | Part No. |
|---|-----------------|
| Scott/Cross-Flow II Kit 8x00 | N0780616 |
| 1 Slot Quartz Torch | N0780130 |
| 2.0 mm i.d. Alumina Injector | N0781014 |
| Scott Spray Chamber | N0770357 |
| GemTip™ Cross-Flow II Nebulizer | N0780546 |
| Quartz Torch Copper Ignitor Tape – Qty. 50 pcs. | N0781097 |

| Description | Part No. |
|---|-----------------|
| Scott/Cross-Flow II Kit 2x00/4x00/5x00/7x00 DV | N0770731 |
| 1 Slot Quartz Torch | N0770338 |
| Quartz Bonnet | N0775289 |
| 2.0 mm i.d. Alumina Injector | N0775177 |
| Scott Spray Chamber | N0770357 |
| GemTip™ Cross-Flow II Nebulizer | N0770546 |
| Quartz Torch Copper Ignitor Tape – Qty. 120 pcs. | N0775297 |

| Description | Qty | Part No. |
|-------------------------------------|-----|-----------------|
| Organics Kit 8x00 | | N0780608 |
| 3 Slot Quartz Torch | 2 | N0780132 |
| 1.2 mm i.d. Alumina Injector | 2 | N0781007 |
| Baffled Cyclonic Spray Chamber 4 mm | 1 | N0776090 |
| GemCone™ Low-Flow Nebulizer | 1 | N0770358 |
| Cyclonic Spray Chamber Adapter | 1 | N0770614 |
| Injector Adapter Washer | 1 | N0776014 |
| Injector Adapter | 1 | N0776091 |
| Injector Adapter Nut | 1 | N0776025 |
| O-Ring | 1 | 09902207 |
| O-Ring 8.74 ID 1.78 WD | 2 | 09921028 |

| Description | Qty | Part No. |
|--|-----|-----------------|
| Organics Kit 2x00/4x00/5x00/7x00 DV | | N0770420 |
| 3 Slot Quartz Torch | 1 | N0772005 |
| 1.2 mm i.d. Alumina Injector | 1 | N0776093 |
| Baffled Cyclonic Spray Chamber 4 mm | 1 | N0776090 |
| GemCone™ Low-Flow Nebulizer | 1 | N0770358 |
| Cyclonic Spray Chamber Adapter | 1 | N0770614 |
| Injector Adapter Washer | 1 | N0776014 |
| Injector Adapter Nut | 1 | N0776025 |
| Injector Adapter | 1 | N0776091 |
| O-Ring | 1 | 09902207 |
| O-Ring 8.74 ID 1.78 WD | 2 | 09921028 |

| Description | Part No. |
|--|-----------------|
| Organics Kit 4300 V/5300 V/7300 V | N0770732 |
| 3 Slot Quartz Torch | N0771500 |
| Quartz Bonnet | N0775289 |
| 1.2 mm i.d. Alumina Injector | N0771531 |
| Baffled Cyclonic Spray Chamber | N0771501 |
| GemCone™ Low-Flow Nebulizer | N0770358 |
| Quartz Torch Copper Ignitor Tape – Qty. 120 pcs. | N0775297 |

| Description | Qty | Part No. |
|---|--------|-----------------|
| DV Oxygen Addition Kit 2x00/4x00/5x00/7x00/8x00 DV | | N0770689 |
| Baffled Cyclonic Spray Chamber 4mm for Oils w/Oxygen Port | 1 | N0777731 |
| Tygon Tubing | 25 ft. | 02506516 |
| Insert | 4 | 09903094 |
| Tube Fitting | 2 | 09903150 |
| Mass Flow Controller | 1 | N0772006 |
| Adapter for Cyclonic Spray Chamber | 1 | N0770614 |

| Description | Qty | Part No. |
|---|--------|-----------------|
| V Oxygen Addition Kit 4300 V/5300 V/7300 V | | N0770965 |
| Torch Adapter with auxiliary oxygen port | 1 | N0774070 |
| Tygon Tubing Per Iç/0.3M | 25 ft. | 02506516 |
| Insert | 4 | 09903094 |
| Tube Fitting | 2 | 09903150 |
| Mass Flow Controller | 1 | N0772006 |

TORCHES AND TORCH ACCESSORIES

Flat Plate Torch
Part No. N0780130



DEMOUNTABLE QUARTZ TORCHES

Demountable design using one-piece quartz tubing for plasma and auxiliary gas flow. Torches without slots are recommended for organic solvents. 1-slot torches are the standard torch for aqueous solutions. 3-slot torches are typically used for organic analysis.

| ICP Model | Number of Slots | Part No. |
|---------------------------------------|-----------------|-----------------|
| 8x00 | 0 | N0780133 |
| 8x00 (Standard) | 1 | N0780130 |
| 8x00 | 3 | N0780132 |
| 2x00/4x00/5x00/7x00 DV | 0 | N0770343 |
| 2x00/4x00/5x00/7x00 DV (short ver.) | 0 | N0770344 |
| 2x00/4x00/5x00/7x00 DV | 1 | N0770338 |
| 2x00/4x00/5x00/7x00 DV | 3 | N0772005 |
| 2x00/4x00/5x00/7x00 DV Organics Torch | 3 | N0772008 |
| 4300V/5300V/7300V | 3 | N0771500 |
| 7300 V Organics Torch | 3 | N0771561 |
| 3x00 DV | 1 | N0691662 |
| 3000 SCX/3x00 XL | 0 | N0695379 |
| 3000/3000 SCR/3x00 RL | 1 | N0690568 |
| 3000/3000 SCR/3x00 RL | 3 | N0681690 |

Torch Bonnets

The torch bonnet is used as a spacer between the torch and RF load coil.



| ICP Model | Part No. |
|--|-----------------|
| 2x00/4x00/5x00/7x00 | N0775289 |
| 3000/3000 SCR/3x00 RL (for instruments manufactured BEFORE 9/21/94) | N0695295 |
| 3000/3000 SCR/3x00 RL (for instruments manufactured AFTER 9/21/94) | N0695456 |
| 3X00 XL/3x00 DV | N0691664 |



Torch O-Rings

| ICP Model | Dimensions | Part No. |
|---|------------------------|-----------------|
| 8x00 Complete O-Ring Kit Includes: 09200078 (1), 09902131 (1), 09902223 (2), 09921061 (1), 09921062 (1) | | N0780437 |
| 2x00/4x00/5x00/7x00 DV Complete O-Ring Kit Includes: 09902045 (1), 09902131 (1), 09902223 (2), 09921061 (1), 09921062 (1) | | N0770437 |
| 4300V/5300V/7300V Complete O-Ring Kit | | N0770916 |
| 2x00/4x00/5x00/7x00 DV/8x00 (Viton) | 1.171 i.d., 0.139 w.d. | 09902131 |
| 2x00/4x00/5x00/7x00 DV/8x00 (Viton) | 0.799 i.d., 0.103 w.d. | 09902223 |
| 2x00/4x00/5x00/7x00 DV/8x00 | 1.109 i.d., 0.139 w.d. | 09921061 |
| 2x00/4x00/5x00/7x00 DV/8x00 | 1.046 i.d., 0.139 w.d. | 09921062 |
| 2x00/4x00/5x00/7x00 DV/8x00 | 0.801 i.d., 0.070 w.d. | 09902045 |
| 4300V/5300V/7300V (For Ball Joint) | 0.301 i.d., 0.070 w.d. | 09926070 |
| 3x00 XL/3x00 DV/3000 SCX | 0.239 i.d., 0.070 w.d. | 09902006 |
| 3x00 XL/3x00 DV/3000 SCX | 0.364 i.d., 0.070 w.d. | 09902015 |
| 3x00 XL/3x00 DV/3000 SCX | 8.74 i.d., 1.78 w.d. | 09921028 |
| 3x00 XL/3x00 DV/3000 SCX/4300V/5300V/7300V (Inside) | 0.239 i.d., 0.070 w.d. | 09902207 |
| 3x00 XL/3x00 DV/3000 SCX/4300V/5300V/7300V (Outside) | 0.301 i.d., 0.070 w.d. | 09902247 |
| All, O-Ring Lube 2 grams | | 09200078 |

Copper Ignitor Tape

| ICP Model | Qty. | Part No. |
|---------------------|------|------------------|
| 8x00 | 50 | N0781097* |
| 2x00/4x00/5x00/7x00 | 120 | N0775297 |

*Ignitor tape for Quartz and HybridXLT Torch.



EXPECT MORE FROM YOUR TORCH

ONLY FROM PERKINELMER!

Ceramic Quartz Torch

PerkinElmer's HybridXLT™ torch is the latest addition to the family of PerkinElmer genuine sample introduction components. The new ceramic/quartz hybrid design provides the highest performance for your Optima® ICP-OES 8x00 spectrometer. Available only from PerkinElmer, this new torch has an extended lifetime of up to 10x your current quartz torch, increasing instrument uptime and decreasing maintenance costs.



Features and Benefits

- Extended Torch Lifetime – up to 10x improvement
- Viewable plasma compared to a full ceramic design
- Ideal for all sample types, except organic solvents
- Increased instrument uptime
- Lower cost per analysis
- Exclusive patented design
- Lower cost than full ceramic torches

| ICP Model | Number of slots | Part No. |
|-----------|-----------------|-----------------|
| 8x00 | 1 | N0780128 |

Ceramic D-Torch™

The ceramic outer tube is of particular benefit for the analysis of wear metals in engine oils, where quartz outer tubes often suffer from short lifetime. It is also beneficial for Si determinations, where quartz outer tubes may produce high background signals.



D-Torch

Part No. N0777840

Ceramic Outer Tube

Part No. N0777880

Features and Benefits

- Analysis of high-matrix solutions (i.e. fusion samples, samples with high-dissolved solids, samples with high-acid content) which can cause early devitrification or sample deposition when using quartz

Ceramic D-Torch™ and Replacement Parts

| | ICP Model | Description | Part No. |
|--|--------------------------|--|-----------------|
| | 8x00 | D-Torch Assembly including Quartz Outer Tube | N0777840 |
| | 8x00 | Ceramic Outer Tube (optional) | N0777880 |
| | 8x00 | Base and Inner Tube | N0777841 |
| | 8x00 | Quartz Outer Tube | N0777842 |
| | 2x00/4x00/5x00/7x00* | DV D-Torch Quartz including Outer Tube | N0777508 |
| | 2x00/4x00/5x00/7x00 | DV Base and Inner Tube | N0777509 |
| | 2x00/4x00/5x00/7x00 | DV Quartz Outer Tube | N0777510 |
| | 4300/5300/7300V | D-Torch with Quartz Outer Tube | N0777051 |
| | 4300/5300/7300V | Quartz Outer Tube | N0777053 |
| | 4300/5300/7300V | Ceramic Outer Tube | N0777052 |
| | 4300/5300/7300V | Base and Inner Tube | N0777054 |
| | | Retaining Ring for Outer Tube | N0777055 |
| | | Copper Tape for D-Torch Outer Tube | N0777843 |
| | 2x00/4x00/5x00/7x00/8x00 | O-Ring Kit | N0777715 |
| | 4300/5300/7300V | Torch Adapter with Auxiliary Port | N0774070 |

*Ceramic outer tube is not available for this model.

FULL SELECTION OF INJECTORS AND ADAPTERS



ALUMINA INJECTORS

Alumina injectors are corrosion-resistant to all mineral acids including HF and aqua regia. They are also used with less volatile organic solvents, e.g., xylene. The 2.0 mm i.d. Alumina injector is shipped standard with all PerkinElmer ICP-OES instruments. A variety of sizes are available as an alternative to the standard injector.

Alumina Injectors

| ICP Model | Dimensions | Part No. |
|--|--------------|-----------------|
| 8x00 | 0.80 mm i.d. | N0781009 |
| 8x00 | 1.2 mm i.d. | N0781015 |
| 8x00 (1.2 mm entire length of tube) | 1.2 mm i.d. | N0781007 |
| 8x00 | 2.0 mm i.d. | N0781014 |
| 2x00/4x00/5x00/7x00 DV | 0.80 mm i.d. | N0775227 |
| 2x00/4x00/5x00/7x00 DV | 1.2 mm i.d. | N0775228 |
| 2x00/4x00/5x00/7x00 DV (1.2 mm entire length of tube) | 1.2 mm i.d. | N0776093 |
| 2x00/4x00/5x00/7x00 DV | 2.0 mm i.d. | N0775177 |
| 4300V/5300V/7300V | 1.2 mm i.d. | N0771531 |
| 3000/3000 SCR/3x00 RL | 0.85 mm i.d. | N0582186 |
| 3000/3000 SCR/3x00 RL | 1.5 mm i.d. | N0582185 |
| 3000/3000 SCR/3x00 RL | 2.0 mm i.d. | N0582184 |
| 3x00 XL/3x00 DV/ 3000 SCX/4300V/5300V/7300V | 2.0 mm i.d. | N0695362 |



Sapphire Injectors

Features and Benefits

- Sapphire injectors are ideal for silicon applications

| ICP Model | Dimensions | Part No. |
|---|-------------|-----------------|
| 8x00 | 2.0 mm i.d. | N0781008 |
| 2x00/4x00/5x00/7x00 DV Sapphire in PFA base, (connects directly to ESI spray chambers) | 1.8 mm i.d. | N0777044 |
| 2x00/4x00/5x00/7x00 DV | 2.0 mm i.d. | N0775247 |
| 3000/3000 SCR/3x00 RL | 2.0 mm i.d. | N0695495 |
| 3x00 XL/3x00 DV 3000 SCX/4300V/5300V/7300V | 2.0 mm i.d. | N0695494 |



Quartz Injectors

Features and Benefits

- Quartz injectors are designed for organic solvents and non-HF matrices

| ICP Model | Dimensions | Part No. |
|--|--------------|-----------------|
| 8x00 | 0.80 mm i.d. | N0781018 |
| 8x00 | 1.2 mm i.d. | N0781019 |
| 8x00 (1.2 mm entire length of tube) | 1.2 mm i.d. | N0781013 |
| 8x00 | 1.6 mm i.d. | N0781016 |
| 8x00 | 2.0 mm i.d. | N0781050 |
| 8x00 | 3.0 mm i.d. | N0781017 |
| 2x00/4x00/5x00/7x00 DV | 0.80 mm i.d. | N0775225 |
| 2x00/4x00/5x00/7x00 DV | 1.2 mm i.d. | N0775226 |
| 2x00/4x00/5x00/7x00 DV | 1.6 mm i.d. | N0775223 |
| 2x00/4x00/5x00/7x00 DV | 2.0 mm i.d. | N0775014 |
| 2x00/4x00/5x00/7x00 DV | 3.0 mm i.d. | N0775224 |
| 3x00 XL/3x00 DV/ 3000 SCX/4300V/5300V/7300V | 0.8 mm i.d. | N0695461 |
| 3x00 XL/3x00 DV/ 3000 SCX/4300V/5300V/7300V | 1.2 mm i.d. | N0695460 |
| 3x00 XL/3x00 DV/ 3000 SCX/4300V/5300V/7300V | 1.6 mm i.d. | N0695449 |
| 3x00 XL/3x00 DV/ 3000 SCX/4300V/5300V/7300V | 2.0 mm i.d. | N0695442 |

Injector Support Adapters

| ICP Model | Spray Chamber | Part No. |
|------------------------------|---------------|-----------------|
| 2x00/4x00/5x00/7x00 DV 8x00 | All | N0770603 |
| 2x00/4x00/5x00/7x00 DV 8x00* | All | N0776091 |
| 4300V/5300V/7300V (bottom) | Cyclonic | N0771526 |
| 4300V/5300V/7300V (top) | Cyclonic | N0771527 |

*For 1.2 mm entire length injectors N0776093 and N0781007

Injector Support Adapter O-Ring Kits

| ICP Model | Part No. |
|-----------------------------|-----------------|
| 2x00/4x00/5x00/7x00 DV/8x00 | N0770438 |
| 3000/3000 SCR/3x00 RL | N0690269 |
| 3x00 XL/3x00 DV/3000 SCX | N0690769 |

ESI Injectors for Optima 8x00

| Description | Part No. |
|---|-----------------|
| 1.5 mm Sapphire injector | N0782004 |
| 1.8 mm Sapphire injector | N0782005 |
| 1.8 mm Sapphire injector for Optima 8000 Series with adapter for 7x00 | N0782006 |
| 1 mm Quartz injector | N0782007 |
| 1.5 mm Quartz injector | N0782008 |
| 2 mm Quartz injector | N0782009 |
| 2.5 mm Quartz injector | N0782010 |



GENUINE SAMPLE INTRODUCTION SUPPLIES

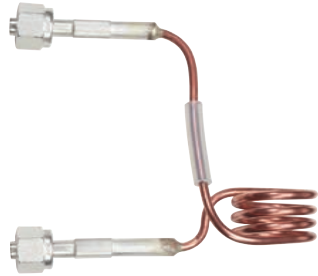

RF LOAD COILS*

| ICP Model | Part No. |
|---|-----------------|
| 2x00/4x00/5x00/7x00 DV | N0775300 |
| 4300V/5300V/7300V | N0771536 |
| 3x00 XL/3x00 DV | N0690772 |
| 3000/3000 SCR/3x00 RL (For instruments manufactured AFTER 9/21/94) | N0690668 |

* Installation by PerkinElmer Service is required, but not included.

RF Load Coil Accessories

| Description | Part No. |
|--|-----------------|
| Igniter Spark Gap Assembly for Type II Demountable Torch | N0680275 |
| Nylon Igniter Standoff | 09989859 |

Purge Component Replacement Parts

For 5x00/7100/7200/7300 DV/8300

| Description | Part No. |
|---|-----------------|
| O-Ring (for Dual View Radial Purge Tube) | 09200064 |
| O-Ring (for Dual View Axial Purge Window) | 09902143 |
| O-Ring (for Torch Clamp on Vertical Torch Module) | 09902155 |
| DV Axial Window Cap | N0773084 |
| DV Axial Window Holder | N0773090 |

For Optima 2100/7000/8000

| Description | Part No. |
|---|-----------------|
| O-Ring (for Dual View Radial Purge Tube) | 09921036 |
| O-Ring (for Dual View Axial Purge Window) | 09921062 |
| Purge Outlet O-Ring | 09921057 |

Radial Window
Part No. N0581497

Axial Window
Part No. 09992731



Purge Extension Windows

The Axial View Purge Extension Window is a replaceable quartz window that slides into the purge extension between the torch and the optics. The Radial View Purge Extension Window Tube is a replaceable quartz tube that slides into the mount between the torch and the optics for the radial view.

| ICP Model | View | Part No. |
|--|-----------|-----------------|
| 2x00/7000/8000 | DV Axial | 09992731 |
| 2x00/7000/8000 | DV Radial | N0690672 |
| 2X00 (long tube) | Radial | B0810377 |
| 3x00/4x00/5x00/7100/ 7200/7300 DV/8300 | DV Axial | N0771116 |
| 5x00/7100/ 7200/7300 DV/8300 | DV Radial | N0770944 |
| 3x00 DV (tube) | DV Axial | N0691678 |
| 3x00 DV (long tube) (38 mm/1.5 in) | DV Radial | N0691689 |
| 3000 SCX/3x00 XL | Axial | 09992731 |
| 3000/3000 SCR/3x00 RL 4300V/5300V/7300V | Radial | N0581497 |
| 4x00 DV/5x00 DV** | DV Radial | N0770322 |

** Pre November 2004



Ceramic Purge Extension

| ICP Model | Part No. |
|---|-----------------|
| 3000/3000 SCR/ 3x00 RL/4300V/5300V/7300V | N0581455 |

Ceramic Interface Cone

The Ceramic Interface Cone includes the Ceramic Cone, the Purge Window (09992731) and the Clamp. The Ceramic Cone is used between the plasma and the spectrometer.

| ICP Model | Part No. |
|------------------|-----------------|
| 3x00 XL/3000 SCX | N0690666 |

QUIET AND OIL-FREE

ICP-OES OIL-LESS AIR COMPRESSORS

PerkinElmer is expanding its product portfolio to include an industrial grade quiet oil-less compressor for dependable, clean and dry air supply. Each compressor comes assembled on an internally and externally coated air tank and includes optional self-purging regenerative air dryer with aftercooler and 5 micron particle filters. One version includes a silencing cabinet resulting in a compressor operating at a very quiet noise level of less than 60dB. All models are equipped with ASME rated pressure tanks and safety valves, line pressure regulator, gauges, and line ball valve for a complete turn key compressor station.



| Specifications | | |
|-----------------------------------|-------------------------------------|------------------------------------|
| Horse Power | | 1.5 HP |
| Output CFM/Output L. | | 6.0 CFM/170 L/min |
| Max Pressure PSI/Max Pressure Bar | | 120 PSI/8 bar |
| Noise Level | | 72 dB/A, with Enclosure 55 dB/A |
| Tank Size Gal./Tank Size L | | 13 Gallons/50 Liters |
| Dimensions | without Enclosure with Enclosure | 25" x 18" x 29" 29" x 23" x 32" |
| Weight | without Enclosure with Enclosure | 97 Lbs. 207 Lbs. |
| Packed Dimensions | without Enclosure with Enclosure | 28" x 21" x 29" 33" x 28" x 39" |

Compressors

| Description | 115V/60Hz | 220V/50Hz | 220V/60Hz |
|--|-----------------|-----------------|-----------------|
| Air Compressor | N0777881 | N0777882 | N0777883 |
| Air Compressor with Dryer | N0777602 | N0777603 | N0777604 |
| Air Compressor with Dryer in Silencing Cabinet | N0777605 | N0777606 | N0777607 |

Product meets both U.S. and Canadian CSA standards. ASME® certified tank.
Please note: Silencing cabinet cannot be sold separately.

Replacement parts

| Description | Part No. |
|-------------------------------|-----------------|
| Replacement Air Intake Filter | N0777608 |
| Micron Dryer Filter Element | N0777609 |
| Replacement Piston Assembly | N0777610 |
| Replacement Reed Valve | N0777611 |
| Replacement Head Gasket | N0777612 |



INSTRUMENT BENCHES AND ACCESSORY CARTS



Optima
Advanced Bench



Optima
Basic Bench



NexION Bench with
Optional Monitor Arm

A CUSTOMIZED APPROACH

Lab space is precious and it can be a challenge to find room for a new instrument or accessory. To make the transition easier, we've customized every bench we offer for your instrument and accessory configuration, enabling you to use your lab space to its full potential. Whether you're making room for a new instrument or replacing an old system, we have a bench solution for you.

Ordering Information

| Dimensions (Depth x Width x Height) | Description | Product Line | Part No. |
|-------------------------------------|---|-------------------|----------|
| 30" x 60" x 34" | PinAAcle Bench | AA | N0777783 |
| 30" x 60" x 35" | Optima Basic Bench | ICP-OES | N0773106 |
| 33" x 21" | Large Shelf for Optima Basic Bench (Shelf Only) | ICP-OES | N0777930 |
| 30" x 60" x 35" | Optima Advanced Bench | ICP-OES | N0771725 |
| 30" x 60" x 29" | NexION Bench with Vacuum Pump Dolly | ICP-MS | N8141230 |
| | NexION Vacuum Pump Dolly Only | ICP-MS | N8121069 |
| 26" | Monitor Arm for Optima Advanced or NexION Bench | ICP-OES/ICP-MS | N0771726 |
| 32" x 30" x 29" | Titan MPS Bench | AA/ICP-OES/ICP-MS | N0777900 |
| 16" x 19" x 34" | Accessory Cart | Various | N0777784 |
| 16" x 22" x 34" | Accessory Cart | Various | N0777785 |



Meinhard Nebulizers

The MEINHARD® Concentric Nebulizer reflects exacting standards in design and manufacturing. Its advantages include simplicity of design and operation, reproducible and self-aligning aerosol, and close fabrication control. They provide excellent sensitivity and precision for aqueous solutions and samples with few dissolved solids (less than 1%). MEINHARD® Nebulizers are self-aspirating and not to be used with solutions containing hydrofluoric acid. Nebulizers require an end cap (N0680504) for use with Scott Spray Chambers.

| Type | Material | AR Flow Rate | Uptake Rate | Part No. |
|--------------------|----------|--------------|-------------|-----------------|
| Type C3 | Glass | 1.0 L/min | 3 mL/min | N8102011 |
| Type K3 | Glass | 1.0 L/min | 3 mL/min | N0681574 |
| Type A3 | Quartz | 1.0 L/min | 3 mL/min | WE024371 |
| Type A0.5 (NexION) | Quartz | 1.0 L/min | 0.5 mL/min | N8145011 |
| Type C0.5 (NexION) | Glass | 1.0 L/min | 0.5 mL/min | N8145012 |

*Liquid Connector WE024372 not included with Meinhard nebulizers.

MEINHARD® Plus Nebulizers

MEINHARD® Plus Nebulizers provide low dead volume and high sensitivity with excellent detection limits and washout. Each Plus nebulizer includes the FitKit+ gas and sample quick connect fittings. The connections are made with high-purity PFA, minimizing the chance of contamination during backflow events. The gas connection fits snugly over the maria on the sidearm of the nebulizer.

| Description | Material | AR Flow Rate | Uptake Rate | Part No. |
|-------------------------|----------|--------------------|-------------|-----------------|
| SilQ+ Ultra-high Purity | Quartz | 1.0 L/min | 0.5 mL/min | N8122460 |
| TQ+ High Sensitivity | Quartz | 1.0 L/min | 0.5 mL/min | N8122461 |
| TQ+ High Sensitivity | Quartz | 1.0 L/min (30 psi) | 0.5 mL/min | N8142098 |
| TR+ High Sensitivity | Glass | 1.0 L/min | 0.5 mL/min | N8122462 |











*Includes FG Gas Quick Connect (N8121036) and F2 Quick Connect (N8121039) with 0.5 mm i.d. (orange marker) capillary, 70 cm.

Liquid Connector

Low dead volume PEEK connector for use with MEINHARD® Concentric Nebulizers. Requires 0.062 in (1.59 mm) o.d. tubing (WE024375). Standard on ELAN DRCs. Not required for PFA PTFE Nebulizers.

| ICP-MS Model | Part No. |
|--|-----------------|
| ELAN (solution fitting, 0.7 mm ETFE) | WE024372 |
| NexION (solution fitting, 0.5 mm PTFE) | N8145016 |

Connectors and Nebulizer Spares

| Description | Part No. |
|---|-----------------|
|  Nebulizer Clip for Meinhard Nebulizers | N0777460 |
|  Nebulizer Liquid Connector Kit 4 mm (solution fitting, 0.5 mm PTFE with adapter) (NexION) | N8145016 |
|  PFA FG Gas Quick Connect | N8121036 |
|  F2 Standard Integrated Capillary (0.5 mm i.d. orange 70 cm long) | N8121039 |
|  F0 Encapsulated Micro Tubing (0.25 mm i.d. green 70 cm long) | N8121038 |
|  F1 Detachable Capillary (0.80 mm i.d. blue 70 cm long) | N8121037 |
|  Spray Chamber Drain Fitting | N8145015 |
|  Male Barb CTFE Fitting (Part of N8145016) | N8145017 |
|  Female Barb CTFE Fitting (Part of N8145016) | N8145018 |
|  PTFE Sample Capillary 0.062 o.d. x 0.020 i.d. | WE024375 |
|  Liquid-End Nebulizer Connector (ELAN) | WE024372 |

End Cap for Concentric Nebulizers

End cap to fit any concentric nebulizer onto a Scott Spray Chamber.



| Description | Part No. |
|-----------------------------------|-----------------|
| End Cap for Concentric Nebulizers | N0680504 |

GemClean Cross-Flow II Nebulizer

Complete chemically inert Cross-Flow II nebulizer assembly for ICP-MS. Specially processed to reduce BEC levels below 1 ppb. Contains an end cap with a GemTip clear sapphire sample tip and a GemTip red ruby argon tip optimized for ICP-MS.



| Description | Part No. |
|----------------------------------|-----------------|
| GemClean Cross-Flow II Nebulizer | N8120516 |

Cross-Flow Replacement GemTips and Spares

Includes a clear sapphire sample tip and a red ruby argon tip optimized for ICP-MS. The tips are constructed of PEEK for maximum corrosion resistance. Used in all GemClean Cross-Flow II nebulizers produced after September, 1998.



| Description | Part No. |
|--|-----------------|
| Cross-Flow II Replacement GemTips | N8120515 |
| Cross-Flow II Nebulizer Argon Ferrule | 09920515 |
| Cross-Flow II Nebulizer Ferrule Kit* | N0680612 |
| Cross-Flow II Nebulizer End Cap | N8122239 |
| Cross-Flow II Nebulizer Sample Ferrule | 09920518 |
| GemTip II O-Ring | 09921045 |
| End Cap O-Ring | 09902033 |
| Sample Tubing | 09985708 |
| Argon Tubing | 09985723 |

*Includes 09920515 and 09920518.

MicroMist Nebulizers

The MicroMist micro-uptake glass concentric nebulizer offers high performance for limited sample volumes. MicroMists with sample uptakes 0.2 – 0.4 mL/min are fitted with a UniFit connector with 1.3 o.d. x 0.50 mm i.d. x 700 mm long sample tubing. MicroMists with sample uptakes 0.05 – 0.1 mL/min are fitted with a UniFit connector with 1.3 o.d. x 0.25 mm i.d. x 700 mm long sample tubing. All MicroMist nebulizers glass are supplied with the EzyLok argon connector.

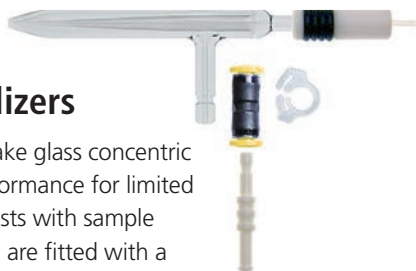

| AR Flow Rate | Uptake Rate | Part No. |
|--------------|-------------|-----------------|
| 1.0 L/min | 0.4 mL/min | N0775341 |
| 1.0 L/min | 0.2 mL/min | N0775342 |
| 1.0 L/min | 0.1 mL/min | N0775343 |
| 1.0 L/min | 0.05 mL/min | N0775344 |

SeaSpray Nebulizers

The SeaSpray Concentric Nebulizer is ideal for samples with high dissolved solids and offers outstanding nebulization efficiency for trace level analysis. It offers freedom from clogging while nebulizing solutions near the limit of solubility of most mineral salts, and conferring significant sensitivity gains. All SeaSpray Nebulizers are supplied with the EzyLok Argon connector.



| AR Flow Rate | Uptake Rate | Part No. |
|------------------|-------------|-----------------|
| 1.0 L/min | 2 mL/min | N0775340 |
| 1.0 L/min | 1 mL/min | N0774069 |
| 1.0 L/min Quartz | 1 mL/min | N0774069 |
| 1.0 L/min | 0.4mL/min | N077484 |

DuraMist Nebulizers

The DuraMist concentric nebulizer is an economical nebulizer for high precision analyses involving samples digested in HF. The DuraMist nebulizer is recommended for samples containing up to 5% HF. For samples with higher concentrations of HF, the OpalMist PFA nebulizer is recommended.



| AR Flow Rate | Uptake Rate | Part No. |
|--------------|-------------|-----------------|
| 1.0 L/min | 0.4 mL/min | N8121046 |
| 1.0 L/min | 1.0 mL/min | N8121045 |

Connectors for MicroMist and SeaSpray Nebulizers



| Description | Pkg. | Part No. |
|--|------|-----------------|
| UniFit | | |
| 0.25 mm ID x 1.27 mm OD x 700 mm long | 10 | N0777514 |
| 0.50 mm ID x 1.27 mm OD x 700 mm long | 10 | N0777513 |
| 0.75 mm ID x 1.27 mm OD x 700 mm long | 10 | N0777512 |
| 1.30 mm OD X 0.75 mm ID x 700 mm long | 3 | N0774077 |
| 1/16 inch OD X 0.75 mm ID x 700 mm long | 3 | N0774080 |
| UniFit-EzyFit Sample Tube | 6 | N0777061 |
| EzyFit | | |
| 0.25 mm ID x 1.27 mm OD x 700 mm long | 10 | N0777437 |
| 0.50 mm ID x 1.27 mm OD x 700 mm long | 10 | N0777436 |
| 0.75 mm ID x 1.27 mm OD x 700 mm long | 10 | N0777435 |
| 0.25 mm ID x 1/16" OD x 700 mm long | 10 | N0777464 |
| 0.50 mm ID x 1/16" OD x 700 mm long | 10 | N0777463 |
| 0.50 mm ID x 1/16" OD x 700 mm long Twin | 6 | N0777462 |
| 1/16 inch OD x 0.25mm ID x 700mm | 10 | N0777845 |
| 1/16 inch OD x 0.50mm ID x 700mm | 10 | N0777846 |
| 1/16 inch OD x 0.75mm ID x 700mm | 10 | N0777847 |
| UniFit-EzyFit Sample Tube | 6 | N0777061 |

OpalMist Nebulizers

The OpalMist is ideal for the geochemistry & semiconductor industry. The OpalMist PFA concentric nebulizer is for high precision analyses involving analyses requiring high chemical resistancy to HF, alkalis and organics. It also provides excellent results for trace analyses.



| AR Flow Rate | Uptake Rate | Part No. |
|--------------|-------------|-----------------|
| 1.0 L/min | 0.4 mL/min | N0777485 |
| 1.0 L/min | 0.1 mL/min | N0777486 |
| 1.0 L/min | 0.2 mL/min | N8121056 |
| 1.0 L/min | 0.05 mL/min | N8121057 |
| 1.0 L/min | 2 mL/min | N8121061 |

The Eluo™ Nebulizer Cleaner

The Eluo is designated to efficiently deliver a cleanser through the nebulizer capillary to dislodge particle build-up and thoroughly clean the nebulizer. One simple action does it all. No more messy procedures, waiting overnight or shattered nebulizers in ultrasonic baths.



| Description | Part No. |
|--|-----------------|
| For Newer OpalMist, PolyCon, DuraMist, Meinhard, other Glass Nebulizers. | N0777712 |
| For OLD style OpalMist or PolyCon Nebulizers. | N0775358 |

HIGH EFFICIENCY MICROFLOW NEBULIZERS

MicroFlow nebulizers are constructed entirely from chemically resistant fluoropolymers, ideal for strong acids, alkalis, organics, high salt solutions and high solid concentrations. They are resistant to clogging, are reliably self-aspirated or pumped and produce a fine aerosol for high transport efficiency and high sensitivity.

PFA-ST Nebulizer

The PFA-ST nebulizer features high purity, HF-resistance, and high performance, along with an exchangeable external sample uptake capillary. The sample uptake rate is controlled by the dimension of the external capillary or probe. For use with autosamplers. Requires a CTFE union (N8122355) to connect to the UltraClean autosampler probe. All-PTFE construction, chemically inert. Chemically resistant—ideal for strong acids, alkalis, organics. Resistant to clogging – reliably self-aspirated or pumped. Low, spike-free background for important elements such as:



- Fe and Ca. Produces a fine aerosol for high transport efficiency and high sensitivity
- Analyze all sample types with a single introduction system
Direct analysis of volatile and non-volatile organic solvents

| Description | Part No. |
|------------------|----------|
| PFA-ST Nebulizer | N8122192 |

PolyPro-ST Nebulizer

The PolyPro-ST Nebulizer is an HF resistant alternative to the PFA nebulizer. The PolyPro has lower chemical resistance than the PFA nebulizer but has the same high efficiency aerosol generation. A robust nebulizer that can self aspirate with an exchangeable external sample uptake capillary or used with a peristaltic pump.

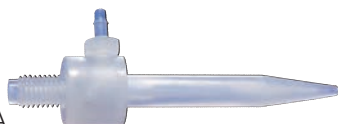

| Description | Part No. |
|----------------------|----------|
| PolyPro-ST Nebulizer | N0777220 |

PFA-ST3 Nebulizer

Designed for superior clog resistance and higher sensitivity. PFA-ST3 nebulizer with external threaded connector is a high performance, clog resistant and chemically inert nebulizer for ICP-MS.



| Description | Part No. |
|-------------------|----------|
| PFA-ST3 Nebulizer | N8145101 |



PFA Nebulizer Obstruction Removal Kit

Obstruction Removal Kit while naturally resistant to obstructions, PFA nebulizers may occasionally require maintenance. Use this kit to safely remove obstructions in all PFA-ST nebulizers for long-term high performance.

| Description | Part No. |
|-----------------------------------|----------|
| Nebulizer Obstruction Removal Kit | N8145236 |

PTFE Sample Capillaries

For use with ST Nebulizers.

| I.D. | Self-Aspiration Rate | Part No. |
|---------------|----------------------|----------|
| 0.15 mm Red | 20 µL/min | N8122382 |
| 0.2 mm Purple | 50 µL/min | N8145135 |
| 0.25 mm Green | 100 µL/min | N8122383 |
| 0.3 mm Yellow | 200 µL/min | N8145136 |
| 0.5 mm Orange | 400 µL/min | N8122384 |
| 0.8 mm Blue | 700 µL/min | N8145137 |
| 1.0 mm Gray | 1 mL/min | N8145138 |

Sample Introduction Kits for NexION

Complete high purity sample introduction system for NexION. All wetted surfaces are PTFE and Pt.



Used by a majority of semiconductor labs worldwide for the analysis of semiconductor grade chemicals and Si wafer samples. Includes 2 PFA MicroFlow Nebulizers, PureCap PFA endcap with additional gas port, PFA spray chamber, Pt injector, Pt Shield and quartz torch.

| Description | Part No. |
|---|----------|
| PFA-Platinum HF-Resistant Sample Introduction Kit | N8142001 |

Complete HF-resistant sample introduction system for NexION. All wetted surfaces are PTFE and Sapphire. Provides a chemically inert and clean introduction system. Includes a PFA-ST Nebulizer, PureCap PFA endcap with additional gas port, PFA spray chamber, Sapphire injector, Pt Shield and quartz torch.

| Description | Part No. |
|--|----------|
| PFA-Sapphire HF-Resistant Sample Introduction Kit | N8142002 |
| HF Sample Introduction Kit Consists of a Scott spray chamber with a Cross-Flow II nebulizer, a 2 mm alumina injector, injector support adapter, O-rings, tubing and connectors. | N8140507 |

Cyclonic Spray Chambers

- The Cyclonic Spray Chamber relies on momentum to efficiently and quickly remove the larger droplets from the sample mist decreasing any opportunity for occlusion or agglomeration of the smaller droplets. The result is higher efficiency, better precision and faster washouts than other spray chamber designs
- Decreased sample introduction system installation and optimization time due to the preset nature of the spray chamber/nebulizer combination
- More samples per hour due to minimal dead volume and efficient draining

Unique design characteristics:

- The nebulizer port is oversized so that sample solution cannot build up around the nebulizer as it will in other cyclonic designs
- The nebulizer port angle is tightly controlled so that the nebulizer mist impacts on the same chamber wall area in each and every spray chamber
- Each spray chamber incorporates a precisely machined ridge a long the inside top of the spray chamber. This eliminates the periodic “spiking” that adversely affects precision and fosters faster washout times

Baffled Cyclonic Spray Chambers

The spray chamber is an integral part of the sample introduction system responsible for filtering the sample mist to permit the appropriate droplet size distribution to reach the plasma. The baffled cyclonic spray chamber features a central transfer tube which acts as a secondary particle separator helping separate larger aerosol particles from the sample. This reduces solvent load in the plasma without compromising detection limits. The distance between the bottom of the baffle and the chamber wall is carefully controlled so that droplets cannot form on the bottom of the baffle. The advantage is smooth draining and improved precision.



Part No. WE025221

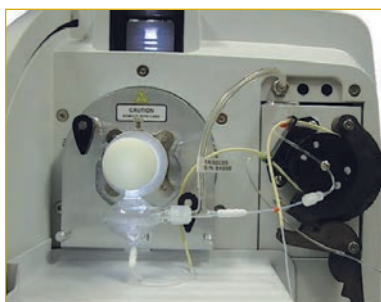

Baffled Quartz Cyclonic Spray Chambers

Baffled Quartz Spray Chamber (PTFE O-Ring type) with ball joint.



Part No. N8145013

| ICP-MS Model | Part No. |
|--|----------|
| NexION* | N8145013 |
| ELAN DRC/DRCplus/DRC II | WE025221 |
| O-Ring for Baffled Quartz Cyclonic Spray Chamber | 09210011 |

*O-Ring free

Baffled Glass Cyclonic Spray Chambers

The Cyclonic Spray Chamber relies on momentum to efficiently and quickly remove the larger droplets from the sample mist decreasing any opportunity for occlusion or agglomeration of the smaller droplets. The result is higher efficiency, better precision and faster washouts than other spray chamber designs. For use with ball joint injectors.



Part No. N8145014

| ICP-MS Model | Part No. |
|---------------------------------------|----------|
| NexION (Standard with NexION Q/X/D)** | N8145014 |
| ELAN | N0773196 |

**O-Ring free



Part No. N0777034

ELAN Baffled Quartz Cyclonic PC³ Spray Chambers

7 mm baffle, aux. gas port, drain line included and connects directly to ESI injectors. An adapter is needed to connect to other injectors. All-purpose for non-HF samples. Provides excellent sensitivity and stability with low background. For use with PC³.

| Description | Part No. |
|----------------------------|----------|
| With Auxillary Gas Port | N0777034 |
| Without Auxillary Gas Port | N0777035 |

SPRAY CHAMBERS



Part No. N8122188



Part No. N0775350

Glass Cyclonic Spray Chamber Kit

Contains one Glass Cyclonic Spray Chamber, mounting hardware and instructions. Requires, but does not include, a concentric nebulizer.

| Description | Part No. |
|--|----------|
| For ELAN 9000/6x00/5x00/DRC-e | |
| Glass Cyclonic Spray Chamber Kit | N8120150 |
| Glass Cyclonic Spray Chamber Only | N8122188 |
| O-Ring Free Glass Cyclonic Spray Chamber | N0775350 |



Part No. N8145120

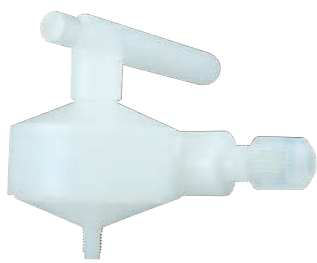

Part No. N8145122

NexION O-Ring Free Baffled Cyclonic PC³ Spray Chambers

Feature o-ring free connections to the nebulizer and torch injector, secure, leak-free threaded drain port, internal baffle and threaded auxiliary port for addition gas.

| Description | Part No. |
|--|----------|
| High Purity Quartz Cyclonic Spray Chamber provides excellent sensitivity and stability with low background | N8145120 |
| Micro Cyclonic Spray Chamber provides the fastest washout at low-flow rates compared to larger versions | N8145121 |
| Borosilicate Glass Spray Chamber | N8145119 |
| PFA Cyclonic Spray Chamber | N8145122 |

Connectors and Spares



Part No. N8141420



Part No. N0777438



Part No. N0777439

| Description | Pkg. | Part No. |
|---|------|----------|
| Helix Locking Screw | 1 | N0777438 |
| Helix Seal | 4 | N0777439 |
| PFA 6 mm Short Length Secure Replacement Nut for Quartz Cyclonic Spray Chambers | 1 | N8141420 |
| PFA 6 mm Long Length Secure Replacement Nut for Quartz Cyclonic Spray Chambers | 1 | N8145321 |



Part No. N8120124

Scott Spray Chambers

Complete HF-resistant Scott Spray Chamber Includes (1) large O-Ring (WE013060), (1) Retaining Ring (WE014081) and (1) Right-Angled Drain Connector (WE013119).

| Description | Part No. |
|--|----------|
| For NexION/ELAN 9000/6x00/5000/DRC-e | |
| Scott Spray Chamber | N8120124 |
| Scott Spray Chamber Large O-Ring | WE013060 |
| Scott Spray Chamber Retaining Ring | WE014081 |
| End-cap for Concentric Nebulizer. Ryton endcap to fit nebulizer onto Scott Spray Chamber | N0680504 |



Part No. N8142000

PFA PTFE Scott Spray Chamber

UltraClean, low volume 47 mm Scott Spray Chamber. For use with concentric nebulizers. Requires a PFA injector assembly and the PFA End Cap (N8122357).

| Description | Part No. |
|--|----------|
| PFA PTFE Scott Spray Chamber | N8122356 |
| PFA Spray Chamber with PFA End Cap for NexION* | N8142000 |

* Requires PFA body injector N8122411 or N8122412 or N8122413.



Part No. N8145099



Part No. N8142003

PC³ Peltier Coolers for NexION

The PC³ is a small and robust Peltier cooler for ICP-MS cyclonic spray chambers. The cyclonic spray chamber offers the advantages of low memory effects, fast rinseout and high sample transport efficiency. The PC³ cools the outer walls of the cyclonic spray chamber to a constant temperature, enhancing long-term signal stability, reducing polyatomic interferences such as oxides, and reducing solvent loading when volatile organic solvents are analyzed. The PC³ has 2 preset temperatures +2 °C / -5 °C and is ideal for analysis of aqueous or aqueous/organic mixtures. The PC³-LT operates at -20 °C to reduce the solvent load on the plasma for analysis of 100% volatile organic solvents.

| Description | Injector Size | Temperature | Additional Gas Port | Part No. |
|---|---------------|----------------|---------------------|-----------------|
| PC ³ Sample Introduction Kit* | 1.5 mm | +2 °C / -5 °C | Yes | N8142003 |
| HF PC ³ Sample Introduction Kit* | 1.5 mm | +2 °C / -5 °C | Yes | N8145309 |
| PC ³ -LT Organic Sample Introduction Kit* | 1.0 mm | +2 °C / -20 °C | Yes | N8145099 |
| HF PC ³ -LT Organic Sample Introduction Kit* | 1.5 mm | +2 °C / -20 °C | Yes | N8145310 |

* All PC³ kits include a PFA-ST nebulizer (N8122192).

PC^{3x} Peltier Controlled Heated or Cooled Cyclonic Chamber for NexION



The PC^{3x} is a compact Peltier heated or cooled inlet system that controls the spray chamber temperature and improves long-term stability. In cooling mode, water or solvent is removed from the aerosol, reducing water or solvent loading on the plasma. In heating mode, sensitivity is increased and volatility-related sample transport effects can be reduced or eliminated.

- Variable temperature control from -10 °C to +80 °C
- Thermal stabilization of spray chamber improves long-term stability
- Last set temperature saved for stand alone operation
- USB or Bluetooth connectivity
- Remote monitoring and control

| Description | Part No. |
|--|-----------------|
| PC ^{3x} thermally stabilized inlet system | N8145340 |

PC³ Peltier Coolers for ELAN

The PC³ is a small and robust Peltier cooler for ICP-MS cyclonic spray chambers. The cyclonic spray chamber offers the advantages of low memory effects, fast rinse-out and high sample transport efficiency. The PC³ cools the outer walls of the cyclonic spray chamber to a constant temperature, enhancing long-term signal stability, reducing polyatomic interferences such as oxides, and reducing solvent loading when volatile organic solvents are analyzed. The PC³ has two preset temperatures +2 °C / -5 °C and is ideal for analysis of aqueous or aqueous/organic mixtures. The PC³-LT operates at +2 °C / -20 °C to reduce the solvent load on the plasma for analysis of 100% volatile organic solvents.



| ICP-MS Model | Part No. |
|-----------------------------|-----------------|
| ELAN Cassette Torch Mount | N8122410 |
| ELAN Twist Type Torch Mount | N8122389 |
| ELAN PC ³ -LT | N8122452 |



IsoMist Programmable Temperature Spray Chambers

The IsoMist Programmable Temperature Spray Chamber lets you select any temperature between -10 °C and +60 °C in 1 °C increments to provide the optimum conditions for any application. The rapid response of the Peltier device allows a spray chamber temperature of -5 °C to be reached within 15 minutes. The spray chamber temperature can be monitored through a temperature versus time plot on your PC screen. And, for regulatory compliance, the temperature versus time data file can be saved with your results. If these features are not required, once the temperature has been programmed, the IsoMist can be run in stand-alone mode without a PC connection.

- Temperature range: -10 °C to +60 °C
- Temperature set in 1 °C increments
- Temperature stability: +/- 0.1 °C

| ICP-MS Model | Part No. |
|--------------|-----------------|
| ELAN | N0777364 |
| NexION | N8141426 |

INJECTORS AND ADAPTERS



Alumina Injectors

Alumina injectors are compatible with twist type and cassette torch mounts. They are vacuum baked to reduce contamination.

Features and Benefits

- 2.0 mm i.d. for use with HF-resistant sample introduction system. Standard injector for aqueous solutions and less volatile organic solvents
- 0.85 mm i.d. for use with volatile organic solutions on the HF-resistant sample introduction system

Alumina Injectors for NexION/ELAN DRC-e/9000/6x00/5000/500

| Dimension | Part No. |
|--------------|-----------------|
| 2.0 mm i.d. | N8126041 |
| 1.5 mm i.d. | N8126040 |
| 0.85 mm i.d. | N8126039 |

Quartz Injectors



Quartz Injectors are compatible with twist type and cassette torch mounts. The ELAN DRC II uses a specially designed all-quartz sample introduction system to minimize background contamination levels. The standard 2.0 mm i.d. quartz injector is held by a specially designed pass-through, injector support assembly to minimize contact with materials that could cause sample contamination, a must for determinations made at the parts-per-trillion level.

Quartz Injectors

For the NexION/ELAN DRC-e/9000/6x00/5000 when using the HF-Resistant Sample Introduction System (WE024782).

| Description | Recommended Use | Part No. |
|-------------|------------------|-----------------|
| 1.2 mm i.d. | Organic Solvents | N0681631 |
| 1.6 mm i.d. | Organic Solvents | 00473292 |
| 2.0 mm i.d. | Clinical Samples | N8125029 |

Quartz Ball Joint Injectors



For NexION/ELAN DRC/DRCplus/DRC II. For use with Pass-Through Ball Joint Injector Support Adapters (WE023951 or W1012406).

| Description | Recommended Use | Part No. |
|---------------|-------------------|-----------------|
| 0.85 mm i.d.* | Volatile Organics | WE027030 |
| 1.5 mm i.d.* | Organics | WE027005 |
| 2.0 mm i.d. | General Purpose | WE023948 |

*For reduced sample loading.

Sapphire Injectors



Sapphire Injector Tube, 2.0 mm i.d.

Demountable injector for use with the HF-resistant sample introduction system. Not for use with PFA sample introduction system.

| Dimension | Part No. |
|----------------------------------|-----------------|
| NexION/ELAN DRC-e/9000/6x00/5000 | N0695495 |

PFA Injector Assemblies

PFA/Quartz Torch Injector Assembly

| Description | Dimension | Part No. |
|-----------------------|-------------|-----------------|
| PFA/Quartz Twist Type | 1.5 mm i.d. | N8122394 |
| PFA/Quartz Cassette | 1.5 mm i.d. | N8122413 |

PFA/Sapphire Torch Injector Assembly

| Description | Dimension | Part No. |
|-------------------------|-------------|-----------------|
| PFA/Sapphire Twist Type | 1.8 mm i.d. | N8122358 |
| PFA/Sapphire Cassette | 1.8 mm i.d. | N8122411 |

PFA/Platinum Torch Injector Assembly

| Description | Dimension | Part No. |
|-------------------------|-------------|-----------------|
| PFA/Platinum Twist Type | 2.0 mm i.d. | N8122359 |
| PFA/Platinum Cassette | 2.0 mm i.d. | N8122412 |

Injector Support Adapters



| ICP-MS Model | Part No. |
|--|-----------------|
| ELAN DRC/DRCplus/DRC II | |
| Ball Joint Twist Type Torch Injector Support Adapter | WE023951 |
| ELAN DRC II | |
| Ball Joint Cassette Torch Injector Support Adapter | W1012406 |
| ELAN 9000/6x00/5000/DRC-e | |
| Twist Type Torch Injector Support Adapter | N8122007 |
| Twist Type Torch Injector Support Adapter (Assembled with O-Rings) | N8120116 |
| NexION/ELAN 9000/6x00/5000/DRCs | |
| Injector Support Adapter O-Ring Kit | N8120100 |
| Cassette Torch Injector Support Adapter For Non-Ball Joint Injectors | W1013266 |
| Cassette Torch Injector Support Adapter For Ball Joint Injectors | W1012406 |

Injector Support Adapter O-Rings

| Position | Torch Type | Part No. |
|------------------|--------------------------------|-----------------|
| Internal | Twist/Cassette | 09210011 |
| External (large) | Cassette | W1013545 |
| External | Twist/Cassette | 09210012 |
| Internal | Cassette (non-Ball Joint only) | N8122010 |
| Internal | Twist (non-Ball Joint) | WE013060 |

Injector Adapter Kits and O-Rings can be found on the next page.

Injector Adapter Kits and O-Rings

| Description | Qty | Part No. |
|--|-----|-----------------|
| For NexION Injector Adapter Kit (Includes items listed below) N8140360 | | |
| Adapter | 1 | W1012406 |
| O-Ring 3/8 inch i.d. x 1/16 inch | 1 | W1008572 |
| O-Ring 1/4 inch i.d. x 1/16 inch | 1 | W1008573 |
| Injector Spacer | 1 | W1012409 |
| Injector Nut | 1 | W1012408 |
| For NexION Injector Adapter Kit 2 (Includes items listed below) N8140527 | | |
| Injector O-Ring 0.239 i.d. x 0.070 WD | 1 | 09210011 |
| O-Ring 0.551 i.d. x 0.070 WD | 1 | N8122010 |
| O-Ring 3/8 inch i.d. x 1/16 inch | 1 | W1008572 |
| Adapter | 1 | W1012406 |
| Injector Nut | 1 | W1012408 |
| Injector Spacer | 1 | W1012409 |
| O-Ring 5/8 inch i.d. x 1/8 inch WD | 1 | W1013545 |
| For ELAN Cassette O-Ring Kit for Injector Support (Includes items listed below) N8120100 | | |
| Injector O-Ring 0.239 i.d. x 0.070 WD | 2 | 09210011 |
| Torch O-Ring 0.364 i.d. x 0.070 WD | 2 | 09210012 |
| O-Ring 0.551 i.d. x 0.070 WD | 1 | N8122010 |
| O-Ring 5/8 inch i.d. x 1/8 inch WD | 1 | W1013545 |

Demountable Quartz Torch

The EasyGlide™ torch mount and alignment system used in the ELAN and NexION ICP-MS system. It is a demountable design that incorporates a quartz torch with a fully replaceable sample injector made of fused alumina, quartz or sapphire.



| ICP-MS Model | Part No. |
|--------------|-----------------|
| NexION/ELAN | N8122006 |

High Efficiency Demountable Quartz Torch

Demountable Quartz Torch only. Operates at 25% reduced argon gas flows compared to the Demountable Quartz Torch (N8122006). The ELAN 9000 and 6x00 require the High Efficiency Torch Kit (W1007468) for first time installation.



| ICP-MS Model | Part No. |
|---------------------|-----------------|
| ELAN 9000/6x00/DRCs | W1008384 |
| NexION | N8145318 |

High Efficiency Torch Kit

Includes the High Efficiency Torch (W1008384) and flow restrictors required for use with the ELAN 9000 and 6x00.

| ICP-MS Model | Part No. |
|--------------------|-----------------|
| ELAN 9000 and 6x00 | W1007468 |

O-Ring-Free Demountable Quartz Torch

Demountable quartz torch for o-ring-free injectors. Use with ESI o-ring-free injectors.

| ICP-MS Model | Part No. |
|--------------|-----------------|
| ELAN/NexION | N8145106 |



Ceramic D-Torch

Part No. **N0777415**

Part No. **N0777419**

The D-Torch is a revolutionary new demountable torch design. With the D-Torch, you need only replace the outer tube with interchangeable quartz and ceramic outer tubes.

| Description | Part No. |
|--|-----------------|
| D-Torch complete with Quartz Outer Tube | N0777419 |
| D-Torch complete with Ceramic Outer Tube | N0777415 |
| Base and Inner Tube | N0777416 |
| Ceramic Outer Tube | N0777417 |
| Quartz Outer Tube | N0777420 |
| Retaining Ring | N0777055 |

Torch Alignment Tool

Used to align the torch in the load coil.

| ICP-MS Model | Part No. |
|----------------------------|-----------------|
| NexION/ELAN 9000/6x00/DRCs | WE015554 |

Cassette Torch Mount

The Cassette Torch Mount is an innovative torch design that is fully modular, demountable, rugged and easy to maintain.



| ICP-MS Model | Part No. |
|-----------------|-----------------|
| NexION | W1037485 |
| ELAN DRC II | W1020672 |
| ELAN 9000/DRC-e | W1020668 |

Does not include Demountable Quartz Torch or Injector.

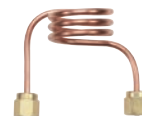

RF Load Coil Assemblies

| ICP-MS Model | Part No. |
|----------------------------|-----------------|
| NexION/ELAN 9000/6x00/DRCs | WE021816 |
| ELAN 5000 | WE012411 |

Power Amplifier Tube (Ceramic)

| ICP-MS Model | Part No. |
|---|-----------------|
| NexION/ELAN 9000/6x00/DRCs and ELAN 5000As manufactured after September, 1992 | N0695477 |

NexION SimulScan Dual-Stage Detector

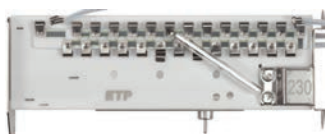

The dual-stage detector is an integral part of the NexION 300 ICP-MS SimulScan™ system. This electron multiplier measures both high- and low-level analytes simultaneously. This conserves valuable or limited samples, eliminates the need to perform time-consuming sample dilutions and allows you to quickly characterize unknown samples.

| ICP-MS Model | Part No. |
|--------------|-----------------|
| NexION* | N8145000 |

Original SimulScan Dual-Stage Detector



The original dual-stage detector is an integral part of the ELAN SimulScan™ system. This electron multiplier measures both high- and low-level analytes simultaneously. This conserves valuable or limited samples, eliminates the need to perform time-consuming sample dilutions and allows you to quickly characterize unknown samples.

| ICP-MS Model | Part No. |
|--|-----------------|
| ELAN 9000/6x00/DRCs* manufactured prior to April, 2005 | N8125001 |

Improved SimulScan Dual-Stage Detector

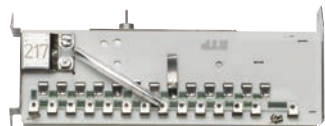

The improved Dual-Stage Detector is designed for better stability and longer lifetime than its predecessor. ELAN instruments produced after April, 2005 have the proper electronics to accept this detector without modification. ELAN instruments manufactured before April, 2005 will require a one-time upgrade to the Detector Electronics (W1013195). Using this detector in an instrument without the upgraded electronics will result in higher noise levels and shorter lifetime.

| ICP-MS Model | Part No. |
|----------------------|-----------------|
| ELAN 9000/6x00/DRCs* | N8125050 |

Detector Electronics Upgrade Kit

Boosts detector life at least 20%.

| ICP-MS Model | Part No. |
|--|-----------------|
| ELAN 9000/6x00/DRCs* manufactured prior to April, 2005 | W1013195 |

* Service installation is required, but not included.

Ion Optics

PerkinElmer offers the industry's only single-ion lens with the exclusive SwiftMount™ II cassette lens mount. No tools are required as the design incorporates a clean capture-and-release concept.

Ion Lens

| Description | ICP-MS Model | Part No. |
|-------------------------------|--|-----------------|
| Cassette Ion Lens Upgrade Kit | ELANs manufactured before April, 2005 | W1017871 |
| Series II Ion Lens | ELAN 9000/6x00/DRCs manufactured after January, 1998 | WE018034 |
| Ion Lens | ELAN 6000s manufactured before January, 1998 | WE014777 |
| Series II Lens Removal Tool | ELAN 9000/6x00/DRCs manufactured between January, 1998 and April, 2005 | W1010620 |

Series II Ion Lens



Series II ShadowStop



ShadowStop

| Description | ICP-MS Model | Part No. |
|--------------------------|--|-----------------|
| Cassette Lens ShadowStop | ELAN 9000/DRCs manufactured after April, 2005 | W1013361 |
| Series II ShadowStop | ELAN 9000/6X00/DRCs manufactured between January, 1998 and April, 2005 | WE029011 |

Vacuum Pump Fluid for ELAN

For use with roughing pumps.

| Pump Model | Part No. |
|------------|-----------------|
| Leybold | N8122004 |
| Varian | N8122308 |

Fomblin (PFPE) Vacuum Pump Fluid

For use with NexION ICP-MS only. One liter Fomblin GV80 fluid (perfluoro polyether). 1L required per pump.

| Description | Part No. |
|--------------------------|-----------------|
| NexION Vacuum Pump Fluid | N8145003 |

High Vacuum Silicon Grease

For lubrication of vacuum system O-Rings.

| Description | Part No. |
|----------------------------|-----------------|
| High Vacuum Silicon Grease | 09905147 |

TESTED AND APPROVED

Sampler and Skimmer Cones

Precision-designed and manufactured, large-orifice sampler and skimmer cones provide superior long-term stability and resist clogging, allowing analysis under both high and low sample-uptake conditions. Nickel is a very rugged, long-lasting material for the majority of sample types, while platinum is the material of choice for more corrosive samples. The ELAN sampler cone, with a 1.1 mm orifice diameter, and the skimmer cone, with a 0.9 mm orifice diameter, are the largest in the industry. They have been designed to maximize signal stability and to minimize clogging during extended runs of samples containing high dissolved solids. The sampler cone, which is continually exposed to the plasma and the sample, utilizes a threadless pop-in, pop-out design for rapid removal.



NexION Cones



ELAN Cones

Nickel Sampler and Skimmer Cones

| ICP-MS Model | Type | Part No. |
|--------------------|---------|----------|
| NexION | Sampler | W1033612 |
| NexION | Skimmer | W1026356 |
| ELAN 9000/6x00/DRC | Sampler | WE021140 |
| ELAN 9000/6x00/DRC | Skimmer | WE021137 |

Platinum Sampler and Skimmer Cones*

| ICP-MS Model | Type | Part No. |
|--------------------|---------|----------|
| NexION | Sampler | W1033614 |
| NexION | Skimmer | W1026907 |
| ELAN 9000/6x00/DRC | Sampler | WE027802 |
| ELAN 9000/6x00/DRC | Skimmer | WE027803 |

* Prices subject to change based on volatile precious metal prices.



Cone Removal Tool

| ICP-MS Model | Part No. |
|--------------------|----------|
| NexION | W1034694 |
| ELAN 9000/6x00/DRC | WE017142 |

Hyper Skimmer Cone and Spares



| Description | ICP-MS Model | Part No. |
|------------------------------|--------------|----------|
| Hyper Skimmer Cone | NexION | W1033995 |
| Hyper Skimmer O-Ring | NexION | 09902123 |
| Hyper Skimmer Screw | NexION | WE027484 |
| Hyper Skimmer Sampler Gasket | NexION | W1040148 |



Part No.
N8145319



Part No.
N8145320

ConeGuard Thread Protector

When cleaning cones which have a screw thread, it is important that the thread is not contacted by any corrosive solution. If the thread gets corroded, the cone may not seal correctly or it may bond to the base and be difficult to remove.

Sampler and Skimmer Cone O-Rings



| ICP-MS Model | Type | Qty. | Part No. |
|--------------------|---------|------|----------|
| ELAN 9000/6x00/DRC | Sampler | 5 | N8120511 |
| ELAN 9000/6x00/DRC | Skimmer | 5 | N8120512 |

| ICP-MS Model | Type | Part No. |
|--------------|-------------------|----------|
| NexION | Sampler ConeGuard | N8145319 |
| NexION | Skimmer ConeGuard | N8145320 |
| ELAN | Skimmer ConeGuard | N8121086 |

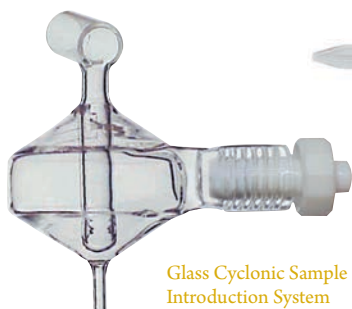

Glass Cyclonic Sample Introduction System

Glass Cyclonic Sample Introduction System for ELAN

| Description | Part No. |
|---|-----------------|
| Glass Cyclonic Sample Introduction System | N8120518 |
| Kit includes (1 of each): | |
| Baffled Glass Cyclonic Spray Chamber O-Ring Free | N0775352 |
| Cyclonic Spray Chamber Mount | WE014034 |
| MicroMist Micro-uptake Glass Concentric Nebulizer 0.2 mL/min. | N0775342 |
| Quartz Injector 2.0 mm i.d. | N8125029 |
| Tygon Tubing (1 foot) | 02506516 |
| Insert | 09903094 |
| ¼ in. Front Ferrule | 09903456 |
| Fitting | 09903464 |
| Tube Fitting | 09903465 |
| Red/Red Standard PVC Tubing 1.14 mm i.d. (Pkg. 12) | 09908585 |
| Green/Yellow Flared End PVC Tubing 0.44 mm i.d. (Pkg. 6) | N0773113 |

Quartz Cyclonic Sample Introduction System for ELAN

| Description | Part No. |
|---|-----------------|
| Quartz Cyclonic Sample Introduction System | N8120519 |
| Kit includes (1 of each): | |
| Baffled Quartz Cyclonic Spray Chamber Baffled Quartz Spray Chamber (PTFE O-Ring Type) with Ball Joint. | WE025221 |
| MicroMist Micro-uptake Glass Concentric Nebulizer Offers High Performance for Limited Sample Volumes. Fitted with an EzyFit Connector with 1.3 o.d. x 0.50 mm i.d. x 700 mm Long Sample Tubing. | N0775342 |
| Quartz Ball Injector 2.0 mm i.d. | WE023948 |
| Tygon Tubing (1 foot) | 02506516 |
| Insert | 09903094 |
| ¼ in. Front Ferrule | 09903456 |
| Fitting | 09903464 |
| Tube Fitting | 09903465 |
| Red/Red Standard PVC Tubing 1.14 mm i.d. (Pkg. 12) | 09908585 |
| Green/Yellow Flared End PVC Tubing 0.44 mm i.d. (Pkg. 6) | N0773113 |
| Ball Joint Cassette Torch Injector Support Adapter | W1012406 |
| UV Safety Shield | W1020996 |
| Connector 1A | B0199233 |



ELAN® DRC-e/9000 Spares Kit

| Description | Qty | Part No. |
|------------------------------------|-----|-----------------|
| ELAN® DRC-e/9000 Spares Kit | | N8120610 |
| Kit Includes: | | |
| Demountable Quartz Torch | 1 | N8122006 |
| RF Coil Assembly | 1 | WE021816 |
| Alumina Injector 2.0 mm i.d. | 1 | N8126041 |
| Cross-Flow II Replacement GemTips™ | 1 | N8120515 |
| Series II Ion Lens | 1 | WE018034 |
| Nickel Sampler Cones | 2 | WE021140 |
| Nickel Skimmer Cones | 2 | WE021137 |
| Sampler Cone O-Rings (Pkg. 5) | 1 | N8120511 |
| Skimmer Cone O-Rings (Pkg. 5) | 1 | N8120512 |



ELAN® DRC II Spares Kit

| Description | Qty | Part No. |
|--|-----|-----------------|
| ELAN® DRC II Spares Kit | | N8120611 |
| Kit Includes: | | |
| Demountable Quartz Torch | 1 | N8122006 |
| RF Coil Assembly | 1 | WE021816 |
| Quartz Ball Joint Injector 2.0 mm i.d. | 1 | WE023948 |
| Series II Ion Lens | 1 | WE018034 |
| Platinum Sampler Cone | 1 | WE027802 |
| Platinum Skimmer Cone | 1 | WE027803 |
| Sampler Cone O-Rings (Pkg. 5) | 1 | N8120511 |
| Skimmer Cone O-Rings (Pkg. 5) | 1 | N8120512 |
| Skimmer Cone O-Rings (Pkg. 5) | 1 | N8120512 |





NexION 300/350Q/X/D Consumables Kit

Typical one year's supply of consumables.

| Description | Qty | Part No. |
|--|-----|-----------------|
| NexION 300/350Q/X/D Consumables Kit | | N8140513 |
| Kit Includes: | | |
| Demountable Quartz Torch | 2 | N8122006 |
| Load Coil | 1 | WE021816 |
| Quartz Ball Joint Injector 2.0 mm i.d. | 2 | WE023948 |
| Cassette Torch Injector Support Adapter for Ball Joint Injectors | 1 | W1012406 |
| Glass Cyclonic Spray Chamber | 1 | N8145014 |
| Nickel Skimmer Cone | 2 | W1026356 |
| Nickel Sampler Cone | 2 | W1033612 |
| Hyper Skimmer Cone | 1 | W1033995 |
| Sampler Cone Gasket | 3 | W1040148 |
| Hyper Skimmer O-Ring | 2 | 09902123 |
| Hyper Skimmer Screw | 2 | 09919737 |
| Santoprene® 1.30 mm Gray/Gray Pump Tubing | 4 | N0777444 |
| Flared PVC 0.38 mm Green/Orange Pump Tubing | 4 | N0777042 |
| Drain Tubing (feet) | 6 | 02506495 |
| Sample Uptake Tubing (cm) | 12 | WE024375 |
| Instrument Filter (left) | 2 | W1036712 |
| Instrument Filter (back right) | 2 | W1036713 |
| Spray Chamber Drain Fitting | 2 | N8145015 |
| Nebulizer Fitting | 2 | N8145016 |
| Male Barb CTFE Fitting | 2 | N8145017 |
| Female Barb CTFE Fitting | 2 | N8145018 |



NexION 300/350S Consumables Kit

Typical one year's supply of consumables.

| Description | Qty | Part No. |
|--|-----|-----------------|
| NexION 300/350S Consumables Kit | | N8140514 |
| Kit Includes: | | |
| Demountable Quartz Torch | 2 | N8122006 |
| Load Coil | 1 | WE021816 |
| Quartz Ball Joint Injector 2.0 mm i.d. | 2 | WE023948 |
| Cassette Torch Injector Support Adapter for Ball Joint Injectors | 1 | W1012406 |
| Quartz Cyclonic Spray Chamber | 1 | N8145013 |
| Platinum Skimmer Cone | 1 | W1026907 |
| Platinum Sampler Cone | 1 | W1033614 |
| Hyper Skimmer Cone | 1 | W1033995 |
| Sampler Cone Gasket | 3 | W1040148 |
| Hyper Skimmer O-Ring | 2 | 09902123 |
| Hyper Skimmer Screw | 2 | 09919737 |
| Santoprene® 1.30 mm Gray/Gray Pump Tubing | 4 | N0777444 |
| Flared PVC 0.38 mm Green/Orange Pump Tubing | 4 | N0777042 |
| Drain Tubing (feet) | 6 | 02506495 |
| Sample Uptake Tubing (cm) | 12 | WE024375 |
| Instrument Filter (left) | 1 | W1036712 |
| Instrument Filter (back right) | 1 | W1036713 |
| Spray Chamber Drain Fitting | 2 | N8145015 |
| Nebulizer Fitting | 2 | N8145016 |
| Male Barb CTFE Fitting | 2 | N8145017 |
| Female Barb CTFE Fitting | 2 | N8145018 |



NexION Spares

| Description | Part No. |
|----------------------------------|----------|
| Metal Spill Tray for vacuum pump | N8145022 |
| UV Shield/Spray Chamber Nut | W1037267 |
| Instrument Filter (left) | W1036712 |
| Instrument Filter (back right) | W1036713 |
| NexION Sample Tray | N8141206 |
| Sample Spill Tray | W5005586 |

ENSURE INSTRUMENT REPRODUCIBILITY

Two-Stop Peristaltic Pump Tubing

PerkinElmer offers a wide range of high-quality peristaltic pump tubing for all of your ICP-OES and ICP-MS applications. Remember to replace your tubing frequently and always keep spares on hand.

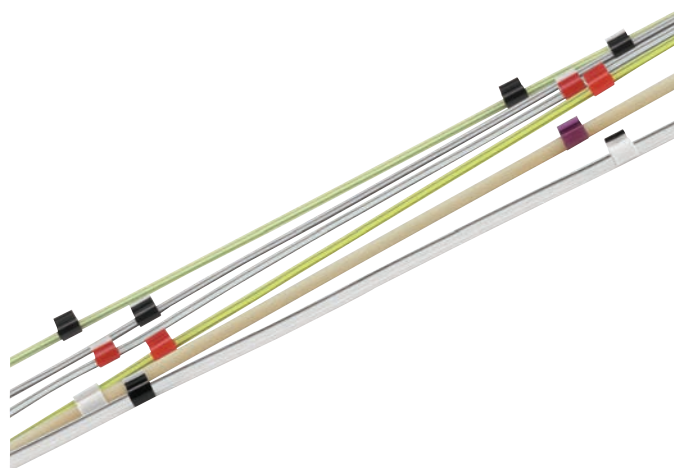

Two-Stop Peristaltic Pump Tubing

| i.d. (mm) | Stop Colors | Standard PVC (Pkg 12) | Flared PVC (Pkg 12) | Solvent Flex (Pkg 12) | Viton® (Pkg 12) | Santoprene® (Pkg 12) | Silicone (Pkg 6) |
|-----------|---------------|-----------------------|---------------------|-----------------------|-----------------|----------------------|------------------|
| 0.19 | orange red | N0695476 | N0773111 | | | | |
| 0.25 | orange blue | N0773117 | N0773112 | | | | |
| 0.38 | orange green | N0777110 | N0777042 | N0777874 | | | |
| 0.44 | green yellow | | N0773113 | | | | |
| 0.51 | orange yellow | | N0777476 | | N0777446 | | |
| 0.64 | orange white | | N0777711 | | | | |
| 0.76 | black black | 09908587 | N0777043 | 00473550 | N0773118 | | 00473552 |
| 1.02 | white white | | | | N0777442 | | N0777441 |
| 1.14 | red red | 09908585 | | 09923037 | N0773115 | N0773119 | N0691595 |
| 1.30 | grey grey | | | | N0777445 | N0777444 | N0777443 |
| 1.42 | yellow yellow | N0777521 | | | | | |
| 1.52 | yellow blue | 09923536 | | | | | |
| 1.65 | blue blue | | | | N0777447 | | |
| 1.85 | green green | N0777518 | | | | N0773116 | |
| 2.06 | purple purple | N0777561 | | | | | |
| 2.79 | purple white | | | 02508080 | | | 09923448 |
| 3.18 | black white | N8122012 | | | | | |



Internal Standard Kits

In-line Standard Additions kits, one which includes a glass mixing chamber/combiner for solutions which do not contain HF and another which includes an inert mixing chamber/combiner. Both kits are completely modular so that damaged or worn components can easily be replaced. The heart of the kit is the mixing chamber/combiner. It is designed for zero dead volume on the input ends which accommodate the sample and addition lines. The output end is designed with a small mixing chamber so that the sample and added reagent are intimately mixed prior to introduction to the nebulizer. All connections to the mixing chamber/combiner use EzyFit connectors. A sampling probe for the reagent addition bottle is included so that it remains well anchored in the bottle. Inline addition of internal standards and ionization buffers provides an efficient means of accurately and precisely dosing all of your samples without extra effort or the risk of error or contamination. Internal standardization is often used to compensate for physical and mass-space interferences in ICP spectrometry. In many cases, it also enhances short-term and long-term reproducibility.

HF-Resistant Internal Standard Kit

| Description | Part No. |
|---|-----------------|
| HF-Resistant Internal Standard Kit | N0774067 |
| Includes: | |
| HF Mixing T-piece | N0777466 |
| Internal Standard Sample Probe 0.25 mm ID | N0777465 |
| EzyFit Sample Tube 0.5 mm ID | N0777463 |
| EzyFit with 1/16 inch OD x 0.50 mm ID x 700 mm Long Sample Tube | N0777436 |
| EzyFit Internal Standard Tube 0.25 mm ID | N0777464 |
| Vitex® Gripper Paper - Qty. 6 | N0777848 |
| Orange-Blue Flared End PVC Tubing 0.25 mm ID – Qty. 12 | N0773112 |

HF-Resistant Internal Standard Kit

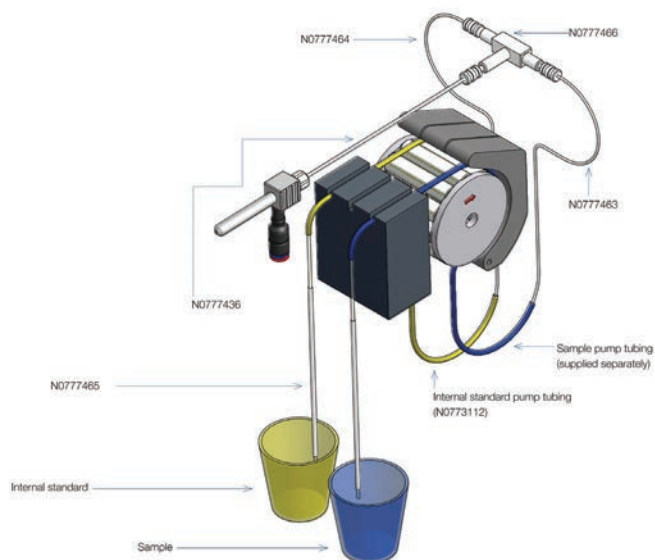

Non HF-Resistant Internal Standard Kit

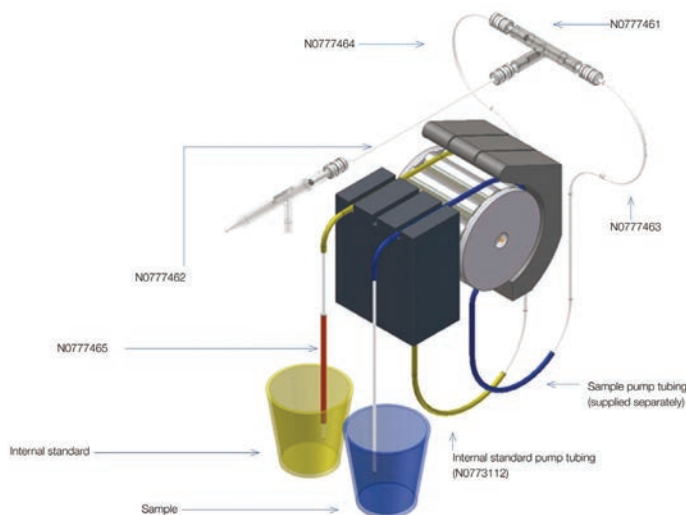

Non HF-Resistant Internal Standard Kit

| Description | Part No. |
|---|-----------------|
| Non HF-Resistant Internal Standard Kit | N0774068 |
| Includes: | |
| HF Mixing T-piece | N0777466 |
| Internal Standard Sample Probe 0.25 mm ID | N0777465 |
| EzyFit Sample Tube 0.5 mm ID | N0777463 |
| EzyFit with 1/16 inch OD x 0.50 mm ID x 700 mm Long Sample Tube | N0777436 |
| EzyFit Internal Standard Tube 0.25 mm ID | N0777464 |
| Vitex® Gripper Paper - Qty. 6 | N0777848 |
| Orange-Blue Flared End PVC Tubing 0.25 mm ID – Qty. 12 | N0773112 |

ESI MP² Two-Stop Peristaltic Pump Tubing



| i.d. (mm) | Stop Colors | Calibration Slope ($\mu\text{L}/\text{min}$ per RPM) | Non-Flared | | | Flared* | |
|---------------|---------------|--|---------------|----------------------|-----------------|---------------|-----------------|
| | | | PVC 2-stop | Santoprene 2-stop | Solva 2-stop | PVC 2-stop | Solva 2-stop |
| 0.13 | orange black | 0.6 | N8145145 | | | N8145194 | N8145208 |
| 0.19 | orange red | 1.3 | N8145146 | | | N8145195 | N8145209 |
| 0.27 | orange blue | 2.7 | N8145147 | | | N8145196 | N8145210 |
| 0.38 | orange green | 4.7 | N8145148 | N8145171 | | N8145197 | N8145211 |
| 0.44 | green yellow | 7.6 | N8145149 | | | N8145198 | N8145212 |
| 0.51 | orange yellow | 9.5 | N8145150 | | | N8145199 | N8145213 |
| 0.57 | white yellow | 11 | N8145151 | | | N8145200 | N8145214 |
| 0.64 | orange white | 14 | N8145152 | | | N8145201 | N8145215 |
| 0.76 | black black | 19 | N8145153 | N8145172 | N8145176 | N8145202 | N8145216 |
| 0.89 | orange orange | 24 | N8145154 | | | N8145177 | N8145217 |
| 0.95 | white black | 28 | N8145155 | | | N8145178 | N8145218 |
| 1.02 | white white | 31 | N8145156 | | | N8145179 | N8145219 |
| 1.09 | white red | 33 | N8145157 | | | N8145180 | N8145220 |
| 1.14 | red red | 35 | N8145158 | | | N8145181 | N8145207 |
| 1.22 | red grey | 46 | N8145159 | | | N8145182 | |
| 1.30 | grey grey | 47 | N8145160 | N8145173 | N8145183 | | |
| 1.42 | yellow yellow | 50 | N8145161 | | | N8145184 | |
| 1.52 | yellow blue | 51 | N8145162 | N8145174 | N8145185 | | |
| 1.65 | blue blue | 55 | N8145163 | | | N8145186 | |
| 1.75 | blue green | 58 | N8145164 | | | N8145187 | |
| 1.85 | green green | 61 | N8145165 | | | N8145188 | |
| 2.06 | purple purple | 64 | N8145166 | | | N8145189 | |
| 2.20 | purple black | 65 | N8145167 | | | N8145190 | |
| 2.54 | purple orange | 67 | N8145168 | | | N8145191 | |
| 2.79 | purple white | 69 | N8145169 | | | N8145192 | |
| 3.17 | black white | 70 | N8145170 | N8145175 | N8145193 | | |
| Bridge Length | | | 72 mm | 72 mm | 72 mm | 72 mm | 72 mm |

* For easy insertion of PFA capillaries

i.d. = internal diameter

Non-Flared



PVC

Santoprene

SOLVA

Three-Stop Peristaltic Pump Tubing

| i.d. (mm) | Stop Colors | Standard PVC Clear (Pkg 12) | Pharmed Tan (Pkg 12) | Solvent Resistant Yellow (Pkg 12) |
|--------------|----------------------|--------------------------------|-------------------------|--------------------------------------|
| 1.65 | black black black | B0506058 | | |
| 1.75 | white white white | | | B0507692 |
| 1.85 | red red red | B0193160 | *B3140730 | |
| 2.06 | yellow blue yellow | B0193161 | | |
| 2.20 | purple purple purple | B0199034 | | |
| 2.54 | purple white purple | | *B3140721 | |
| 2.79 | black white black | B0508310 | | |
| 0.51 | orange yellow orange | B0506737 | | |

* Used for S10 and AS9X autosamplers

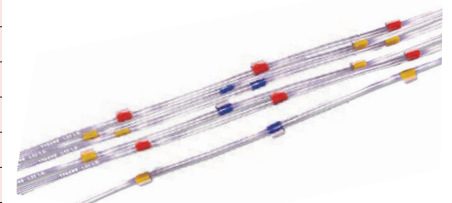

AUTOSAMPLER PROBES AND COMPONENTS

PerkinElmer AS-90/90A/90plus/ 91/93plus/S10 Sampling Probe Assemblies Stainless Steel



| Description | Part No. |
|--|-----------------|
| Flame Sampling Probe Assembly, 0.6 mm i.d. Includes Stainless Steel Sampling Probe and Screw Fitting (B3000152) and Flame Capillary (B3000157 – replaces B0196963) Tubing Assembly. | B3000159 |
| FIAS™ Sampling Probe Assembly, 0.6 mm i.d. Includes Stainless Steel Sampling Probe and Screw Fitting (B3000152) and FIAS Capillary Tubing Assembly (B3000158 – replaces B0196966). | B3000160 |
| FIAS Standard Sampling Probe Assembly, 1.0 mm i.d. Includes Stainless Steel Sampling Probe and Screw Fitting (B3000152) and FIAS Capillary Tubing Assembly (B0191060 – replaces B0501044). | B3000161 |

Corrosion-Resistant

Corrosion-resistant probes are suitable for inorganic acids and most organic solvents, except NMP.

| Description | Part No. |
|--|-----------------|
| Flame Sampling Probe Assembly, 0.6 mm i.d.* Includes Sampling Probe with FEP Tube and Screw Fitting (B3000055) and Capillary Tubing Assembly (B3000157). Standard with AS93plus/S10. | B3001770 |
| FIAS Sampling Probe Assembly, 0.6 mm i.d.* Includes Sampling Probe with FEP Tube and Screw Fitting (B3000055) and FIAS Capillary Tubing Assembly (B3000158). | B3001771 |
| FIAS Standard Sampling Probe Assembly, 1.0 mm i.d.* Includes Sampling Probe with FEP Tube and Screw Fitting (B3001769) and Capillary Tubing Assembly (B0191060). | B3001772 |

*This probe cannot be used with AS-90s, with the older sampling probe holder.

Sampling Probe Assembly Components

| Description | Part No. |
|---|-----------------|
| Stainless Steel Sampling Probe with Screw Fitting Requires, but does not include, one of the capillary tubing assemblies described below. | B3000152 |
| Flame Capillary Tubing Assembly 1 m length, 0.6 mm i.d., one fitting (red) | B3000157 |
| FIAS Capillary Tubing Assembly 1 m length, 0.6 mm i.d., two fittings (red) | B3000158 |
| FIAS Capillary Tubing Assembly 1 m length, 1.0 mm i.d., two fittings (blue) | B0191060 |

| Description | Part No. |
|---|-----------------|
| Corrosion-Resistant Probe only 0.6 mm | B3000055 |
| Corrosion-Resistant Probe only 0.1.0 mm | B3001769 |
| O-Ring to hold Probe | B0172053 |
| Probe Holder (white plastic) | B3000151 |

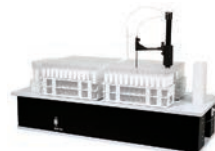

ESI Autosampler Probes

| Description | Part No. |
|---|-----------------|
| Autosampler Probes | |
| Autosampler Probe, 0.15 mm | N0777221 |
| Autosampler Probe, 0.20 mm | N0777222 |
| Autosampler Probe, 0.25 mm | N0777223 |
| Autosampler Probe, 0.30 mm | N0777224 |
| Autosampler Probe, 0.50 mm | N0777225 |
| Autosampler Probe, 0.80 mm | N0777226 |
| Sample Probes | |
| High Flow, Carbon Fiber Support, 0.8 mm i.d. (blue) | N0777285 |
| Low Flow, Carbon Fiber Support, 0.8 mm i.d. (blue) | N0777266 |
| Sample Probe Line Holder | N0777227 |
| Carrier Probes | |
| High Flow, Carbon Fiber Support, 0.5 mm i.d. (orange) | N0777286 |
| Low Flow, Carbon Fiber Support, 0.5 mm i.d. (orange) | N0777267 |



Cetac Carbon Fiber Autosampler Probes

Probes reinforced with rigid carbon fiber to ensure probe accuracy without the use of a guide plate when mounted to a Z-drive with double probe clamps.

| Description | Part No. |
|---------------------------------------|-----------------|
| 0.5 Blue 0.5 mm ID x 108 in - Teflon | N0777547 |
| 1.0 2 Blue 1.0 mm ID x 75 in - Teflon | N0777568 |

Cetac Ultem Autosampler Probes

Probes made with Ultem brand polyetherimide resin are more flexible than the carbon fiber reinforced probes. Use of a Z-drive-mounted guide plate is required.

| Description | Part No. |
|--|-----------------|
| 0.5 mm Blue 0.5 mm ID x 108 in - Teflon | N0774088 |
| 1.0 mm 2 Blue 1.0 mm ID x 75 in - Teflon | N0777565 |

Cetac Stainless Steel Autosampler Probe

| Description | Part No. |
|---|-----------------|
| Steel probe with screen tip (100 mesh) designed for oil analysis. | N0771529 |

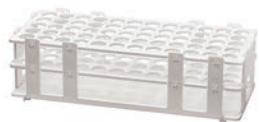

PerkinElmer Sample Trays

AS-93plus/S10 Sample Trays

| Description/Capacity | Sample Vessel Size | Part No. |
|--------------------------------------|--------------------|-----------------|
| Tray F – 9/29* ¹ | 50 mL/15 mL | B3001647 |
| Tray E – 90 ² | 4.5 mL, 6 mL, 8 mL | B3140617 |
| Tray H & Tray F – 60 ³ | 15 mL, 16 mL | B3140618 |
| Tray E, H & Tray G – 21 ⁴ | 50 mL | B3140621 |

* AS-93plus/S10 sample trays are polypropylene.

¹ Rack B3001647 (rinsing-port rack) with rinsing port location (location 0), 8 locations for 50 mL solution containers (calibration and/or test sample solutions), and 29 locations for 15 mL solution containers (test sample solutions).

² Rack B3140617 each with 90 locations for 6 mL and 8 mL solution containers (test sample solutions).

³ Rack B3140618 with 60 locations for 15 mL solution containers (test sample solutions).

⁴ Rack B3140621 with 21 locations each for 50 mL solution containers (calibration and/or test sample solutions). Location 0 in the first rack is for the rinsing port.

AS-90/90A/90plus Sample Trays

| Description/Capacity | Sample Vessel Size | Part No. |
|----------------------|--------------------|-----------------|
| Tray A – 144 | 4.5 mL, 6 mL, 8 mL | B3000133 |
| Tray B – 98* | 15 mL, 16 mL | B3000132 |
| Tray C – 36 | 50 mL | B3000135 |
| Blank Tray | | B0501056 |

*Polypropylene sample tray.

AS-91 Sample Trays

| Description/Capacity | Sample Vessel Size | Part No. |
|--|--------------------|-----------------|
| Tray E – 218 | 4.5 mL, 6 mL, 8 mL | B0509554 |
| 8 - 50 mL spots & Tray F – 152 / 8 (160) | 15 mL, 16 mL | B0509555 |
| Tray G – 55 | 50 mL | B0508520 |

Trays A, C, E, F and G are powder-coated, corrosion-resistant aluminum.

AS-93plus/S10 Rinsing Kit

| Description/Capacity | Part No. |
|---------------------------|-----------------|
| AS-93plus/S10 Rinsing Kit | B3140236 |

Spare Parts

| | |
|--|-----------------|
| Rinsing Port | B3140622 |
| Adapter M | B0507919 |
| Pump Tube – 2.79 mm i.d. (pkg. 6) purple-white | B3140721 |
| Pump Tube – 1.14 mm i.d. (pkg. 6) | B3140730 |
| Tygon® Drain Tube – 2 m red-red-red | B0018283 |
| PVC Rinse Liquid Feed Tube – 1 m | B0048139 |
| Connector | B3140715 |

Cetac Autosampler Racks

Racks

| Rack | Vial Size | Part No. |
|---------------------------------------|---------------|-----------------|
| 21-Position, 30.5 mm square opening | 50 mL | N0777152 |
| 24-Position, 25.2 mm square opening | 30 mL | N0777151 |
| 40-Position, 20.6 mm square opening | 20 mL | N0777150 |
| 30-Position Tall Rack, square opening | 14 mL | N0777062 |
| 40-Position | 20 mL | N0777169 |
| 40-Position/Gilson 29 | 20 mL | N0777155 |
| 45-Position/120 cc Sample Rack (oils) | | N0777298 |
| 60-Position, 17.0 mm square opening | 14 mL or 15mL | N0777149 |
| 80-Position Collection Metal for Oil | 15mL | N0774085 |
| 90-Position, 13.5 mm square opening | 7 mL or 8 mL | N0777148 |
| 90-Position, 13.3 mm round opening | 7 mL or 8 mL | N0777153 |
| 90-Position Collection Metal for Oil | 8 mL | N0777154 |



ESI Autosampler Racks

Racks and Rack Covers

| Description | Size | Diameter | Part No. |
|-----------------------|-------|----------|-----------------|
| Standard Racks | | | |
| 10-Position | | 28 mm | N0777228 |
| 24-Position | 4 x 6 | 14 mm | N0777234 |
| Adapter Plate** | | | N0777235 |

**For Gemetec/Cetac ASX-100's racks

Micro Racks

| | | | |
|-----------------------|--------|-------|-----------------|
| 21-Position | 3 x 7 | 14 mm | N0777229 |
| 40-Position | 4 x 10 | 14 mm | N0777230 |
| 60-Position | 5 x 12 | 8 mm | N0777231 |
| 90-Position | 5 x 12 | | N0777232 |
| Cover for Micro Racks | | | N0777233 |

Large Racks

| | | | |
|-------------|--------|-------|-----------------|
| 21-Position | 3 x 7 | 30 mm | N0777242 |
| 40-Position | 4 x 10 | 20 mm | N0777243 |
| 60-Position | 5 x 12 | 16 mm | N0777244 |
| 90-Position | 6 x 15 | 13 mm | N0777245 |

Super Racks

| | | | |
|----------------|--------|-------|-----------------|
| 10-Position*** | 2 x 5 | 61 mm | N0777253 |
| 12-Position | 2 x 6 | 50 mm | N0777252 |
| 21-Position | 3 x 7 | 22 mm | N0777251 |
| 21-Position | 3 x 7 | 28 mm | N0777250 |
| 21-Position | 3 x 7 | 30 mm | N0777249 |
| 27-Position | 3 x 9 | 28 mm | N0777248 |
| 80-Position | 5 x 16 | 16 mm | N0777247 |
| 120-Position | 6 x 20 | 13 mm | N0777246 |

***Holds 205 mL bottles.

Polypropylene Autosampler Tubes

PerkinElmer translucent polypropylene tubes are designed to provide excellent chemical resistance. PerformR™ 15 mL and 50 mL conical tubes are designed for your routine everyday applications and storage needs. SuperClear™ tubes are made from a unique medical grade resin. PerformR and SuperClear tubes are available with either a flat cap with a two stage seal, or a plug style cap that includes a very deep sealing area.



Round Bottom Tubes



| Description | Type | Size | Pack | Qty | Part No. |
|--|----------|----------------|---------|------|-----------------|
| 5 mL without caps | Standard | 12 mm x 75 mm | Bulk | 500 | B0193235 |
| 8 mL without caps | Standard | 13 mm x 100 mm | Bulk | 1200 | N0777156 |
| 8 mL without caps | Standard | 13 mm x 100 mm | 250/bag | 1000 | N0777159 |
| 8 mL without caps | Standard | 13 mm x 100 mm | Bulk | 1000 | B0508901 |
| 14 mL without caps | Standard | 17 mm x 100 mm | Bulk | 1000 | N0777940 |
| 14 mL with Dual Position, Polyethylene Caps included | Standard | 17 mm x 100 mm | Bulk | 1000 | N0777941 |
| Dual Position Caps for 14 mL, N0777940 Tubes (clear) Caps Only | Standard | | Bulk | 1000 | N0777942 |
| 14 mL without caps | Standard | 17 mm x 100 mm | 250/bag | 1000 | N0777168 |
| 15 mL without plugs | Standard | 17 mm x 100 mm | Bulk | 1200 | N0777167 |
| Plugs for 15 mL N0777167 Tubes, (blue) Plugs Only | Standard | | Bulk | 1200 | N0777599 |
| 15 mL Graduated without plugs | Standard | 17 mm x 100 mm | Bulk | 2000 | N0777071 |
| Plugs for 15 mL N0777071 Tubes, (white) Plugs Only | Standard | | Bulk | 1000 | N0777072 |
| 16 mL without caps | Standard | 17 mm x 100 mm | 250/bag | 1000 | N9301205 |

Conical Bottom Tubes with Graduation



| Description | Type | Size | Pack | Qty | Part No. |
|---|------------|----------------|---------------|-----|-----------------|
| 15 mL with Red Flat Caps attached, (Standard PerkinElmer S10 Tubes) | Standard | 17 mm x 120 mm | 50/bag | 500 | B0193233 |
| 15 mL Sterile Tubes, with Teal Flat Caps attached | Sterile | 17 mm x 118 mm | 50/bag | 500 | N0774095 |
| 15 mL Metal Free Sterile Tubes Racked with White Flat Caps | Sterile | 17 mm x 118 mm | 25/Rack | 500 | N0776118 |
| 15 mL with Teal Flat Caps attached | SuperClear | 17 mm x 118 mm | 50/bag | 500 | N0777701 |
| 15 mL with Teal Flat Caps attached | SuperClear | 17 mm x 118 mm | Racked 50/bag | 500 | N0777702 |
| 15 mL with Teal Flat Caps attached | SuperClear | 17 mm x 118 mm | Bulk | 500 | N0777703 |
| 15 mL with Teal Flat Caps attached | SuperClear | 17 mm x 118 mm | 50/bag | 500 | N0777704 |
| 15 mL with Teal Flat Caps attached | SuperClear | | Racked 50/bag | 500 | N0777705 |
| 15 mL with Teal Plug Caps | SuperClear | 17 mm x 118 mm | Bulk | 500 | N0777706 |
| 50 mL with Red Flat Caps attached, (Standard PerkinElmer S10 Tubes), Freestanding | Standard | 28 mm x 115 mm | 25/bag | 500 | B0193234 |
| 50 mL with Red Flat Caps attached | Standard | 28 mm x 114 mm | 25/bag | 300 | N0777901 |
| 50 mL with Teal Flat Caps attached, Freestanding | PerformR | 30 mm x 116 mm | 50/bag | 500 | N0777697 |
| 50 mL with Teal Flat Caps attached, Freestanding | PerformR | 30 mm x 116 mm | Bulk | 500 | N0777698 |
| 50 mL with Teal Plug Caps attached, Freestanding | PerformR | 30 mm x 116 mm | 50/bag | 500 | N0777699 |
| 50 mL with Teal Plug Caps included, Freestanding | PerformR | 30 mm x 116 mm | Bulk | 500 | N0777700 |
| 50 mL Sterile Tubes with Teal Flat Caps attached | Sterile | 29 mm x 115 mm | 50/bag | 500 | N0774096 |
| 50 mL Metal Free Sterile Tubes Racked with White Flat Caps | Sterile | 30 mm x 116 mm | 25/Rack | 500 | N0776116 |
| 50 mL with Teal Flat Caps attached | SuperClear | 29 mm x 115 mm | 50/bag | 500 | N0777691 |
| 50 mL with Teal Flat Caps attached | SuperClear | 29 mm x 115 mm | Racked 50/bag | 500 | N0777692 |
| 50 mL with Teal Flat Caps included | SuperClear | 29 mm x 115 mm | Bulk | 500 | N0777693 |
| 50 mL with Teal Plug Caps attached | SuperClear | 29 mm x 115 mm | 50/bag | 500 | N0777694 |
| 50 mL with Teal Plug Caps attached | SuperClear | 29 mm x 115 mm | Racked 50/bag | 500 | N0777695 |
| 50 mL with Teal Plug Caps included | SuperClear | 29 mm x 115 mm | Bulk | 500 | N0777696 |

PIONEERED THE USE OF FLOW INJECTION TECHNIQUES



FIMS



FIAS

The use of flow injection saves time, money and manpower — while at the same time, extending your analytical flexibility and capabilities.

PerkinElmer carries a wide selection of genuine supplies and accessories for your FIMS-100, FIMS-400, FIAS-100 or FIAS-400. Keeping your system in good working order by using only the best replacement parts is the first step in assuring quality analytical performance. Regular maintenance and/or replacement of consumables such as tubing, connectors and adapters will maximize the lifetime and productivity of your PerkinElmer flow injection system.

Adapters with Internal Thread

¼ in (6.4 mm) Internal Screw Thread

| Type* | Description | Part No. |
|-------|---|----------------------|
| A B | A 1.8 mm o.d. nipple B 3.3 mm o.d. nipple | B0193342 B0506716 |
| C | 4 mm o.d. nipple | B0196850 |
| E | For the quartz cell | B0196857 |
| F | 0.7 mm o.d. Pt/Ir capillary nipple | B0193873 |
| G | Two nipples to connect tubes to the pre-concentration accessory | B0501580 |

Connectors

| Type* | Description | Part No. |
|-------|---|----------|
| IA | Connector with nipples for 1.7 to 3.2 mm i.d. tubes | B0199233 |
| IB | Connector with nipples for 2.4 to 3.2 mm i.d. tubes | B0196882 |
| II | Connector with ¼ in (6.4 mm) internal screw thread | B0196704 |
| IIIA | T-piece with nipples for 1.5 to 2.5 mm i.d. tubes | B0199035 |
| IIIB | T-piece with nipples for 3.5 to 4.5 mm i.d. tubes | B0198201 |

Adapters with External Thread

¼ in (6.4 mm) External Screw Thread

| Type* | Description | Part No. |
|-------|--|----------------------|
| K L | K 1.8 mm o.d. nipple L 2.8 mm o.d. nipple | B0507918 B0507920 |
| M | 4 mm o.d. nipple | B0507919 |
| N | 0.7 mm o.d. Pt/Ir capillary nipple | B0507949 |
| | Screw Plug | B0507921 |

*Type designation refers to diagrams in instrument manuals.

FIAS/FIMS Cell Replacement Parts

| Description | Part No. |
|--|----------|
| Complete FIAS Cell and Windows | B0507486 |
| FIAS Cell only (no windows) | B0507487 |
| Quartz Windows for FIAS or FIMS | B0066549 |
| FIMS Complete Cell and Windows | B0510334 |
| FIMS Cell Only (no windows) | B0510370 |
| FIMS Hg Lamp | B3000243 |
| FIMS Hg Filter Replacement for Hg Scrubber | B3000274 |

Mixing/Separation Assembly

Complete modular unit, consisting of two mixing manifolds with tubing adapters, a gas liquid separator with a PTFE membrane, five spare PTFE membranes, one PTFE tube (110 mm long) and one PTFE tube (300 mm long).

| Description | Part No. |
|----------------------------|-----------------|
| Mixing/Separation Assembly | B0507957 |

Mixing Block

Modular “building block” type mixing manifold with one mixing channel and three connections, two inlet and one outlet. Made from chemically-resistant plastic. Several of these blocks can be “plugged” together easily to create a single unit with enhanced mixing capabilities.



| Description | Part No. |
|--------------|-----------------|
| Mixing Block | B0507962 |

Gas/Liquid Separator

Modular “building block” type gas-liquid separator made from chemically-resistant plastic. An exchangeable PTFE membrane in the screw cap of the separator prevents liquid from being carried into the quartz cell when working with strong foaming samples.



| Description | Part No. |
|---|-----------------|
| Gas/Liquid Separator | B0507959 |
| Glass Gas/Liquid Separator | B0193772 |
| Gas/Liquid Separator Holder for Glass Separator | B0509479 |
| PTFE Membrane (pkg. 50) | B0508306 |
| Mixing Manifold for Glass Gas/Liquid Separator | B0187258 |

Tool, Screw Connectors

| Description | Part No. |
|------------------------|-----------------|
| Tool, Screw Connectors | B0501315 |

Flow Injection Furnace Supplies

| Description | Part No. |
|-----------------------------------|-----------------|
| FIAS-Furnace Sample Transfer Tube | B0509612 |
| Quartz Pipette Tip/20 mm (pkg. 1) | B0510032 |
| Silicone Tube | B0029796 |

Sample Loops

| Description | Part No. |
|-------------|-----------------|
| 200 µL | B0194048 |
| 500 µL | B0194049 |
| 1,000 µL | B0501000 |

Tubing

Standard PVC clear peristaltic pump tubing has a wall thickness of 0.84 mm.

Three-Stop Peristaltic Pump Tubing, Pkg. 12

| Tubing i.d. | Color Code | Part No. |
|-------------|---------------|-----------------|
| 0.76 mm | Black/black | B0506058 |
| 1.14 mm | Red/red | B0193160 |
| 1.52 mm | Yellow/blue | B0193161 |
| 2.06 mm | Violet/violet | B0199034 |
| 3.18 mm | Black/white | B0508310 |

Solvent Resistant Yellow Peristaltic Pump Tubing, Pkg. 12

| Tubing i.d. | Color Code | Part No. |
|-------------|-------------|-----------------|
| 1.02mm | White/white | B0507692 |

PTFE Tubing

| Tubing i.d. | Length | Part No. |
|-------------|--------|-----------------|
| 0.35 mm | 1 m | B0506060 |
| 0.5 mm | 1 m | B0507020 |
| 0.7 mm | 1 m | B0507021 |
| 1.0 mm | 1 m | B0029792 |
| 1.75 mm | 1 m | B0017998 |

PTFE Tubing Assemblies

| Tubing i.d. | Screw Fittings Color | Length | Part No. |
|--|----------------------|----------|-----------------|
| 0.35 mm | White | 60 mm | B0501594 |
| 1.0 mm | Blue | 110 mm | B0191058 |
| 1.0 mm | Blue | 300 mm | B0198097 |
| 1.0 mm | Blue | 700 mm | B0191059 |
| 1.0 mm | Blue | 1,000 mm | B0191060 |
| 1.75 mm | Black | 250 mm | B0198099 |
| 1.75 mm | Black | 450 mm | B0198100 |
| 3-dimensional reactor 0.35 mm (two flanged ends) | | | B0501595 |

PVC Tubing

| Description | Part No. |
|---|-----------------|
| 3 mm i.d. with 1 mm wall thickness, no fittings | B0048139 |

Price per meter.

Silicone Tubing

| Description | Part No. |
|-----------------------------------|-----------------|
| 1 m x 5 mm i.d., no fittings | B0018283 |
| 1 m x 3 mm i.d. | B0070126 |
| For FIMS Cell Exhaust Outlet, 3 m | B0046948 |

EXPERIENCE RELIABLE, ACCURATE RESULTS



Inorganic Aqueous Standards

PerkinElmer offers a complete selection of atomic spectroscopy aqueous standards. Each solution is supplied with a comprehensive Certificate of Analysis that documents the quality and reliability.

Single-Element Standards – 1,000 µg/mL

| Element | Symbol | Matrix | Pure Grade 125 mL Part No. | Pure Grade 500 mL Part No. | Pure Plus Grade 125 mL Part No. |
|------------|--------|---------------------------|----------------------------------|----------------------------------|---------------------------------------|
| Aluminum | Al | 2% HNO ₃ | N9300184 | N9300100 | N9303726 |
| Antimony | Sb | 2% HNO ₃ | N9300207 | N9300101 | N9303750 |
| Arsenic | As | 2% HNO ₃ | N9300180 | N9300102 | N9303727 |
| Barium | Ba | 2% HNO ₃ | N9300181 | N9300103 | N9303729 |
| Beryllium | Be | 2% HNO ₃ | N9300172 | N9300104 | N9303730 |
| Bismuth | Bi | 10% HNO ₃ | N9303761 | N9300105 | N9303731 |
| Boron | B | H ₂ O | | N9303760 | N9300106 |
| Cadmium | Cd | 2% HNO ₃ | N9300176 | N9300107 | N9303734 |
| Calcium | Ca | 2% HNO ₃ | N9303763 | N9300108 | N9303733 |
| Carbon | C | H ₂ O | | N9303762 | N9300109 |
| Cerium | Ce | 2% HNO ₃ | N9303765 | N9300110 | |
| Cesium | Cs | 2% HNO ₃ | N9303767 | N9300111 | |
| Chromium | Cr | 2% HNO ₃ | N9300173 | N9300112 | N9303736 |
| Cobalt | Co | 2% HNO ₃ | N9303766 | N9300113 | N9303735 |
| Copper | Cu | 2% HNO ₃ | N9300183 | N9300114 | N9303737 |
| Dysprosium | Dy | 2% HNO ₃ | N9303768 | N9300115 | |
| Erbium | Er | 2% HNO ₃ | N9303769 | N9300116 | |
| Europium | Eu | 2% HNO ₃ | N9303770 | N9300117 | |
| Gadolinium | Gd | 2% HNO ₃ | N9303773 | N9300118 | |
| Gallium | Ga | 2% HNO ₃ | N9303772 | N9300119 | |
| Germanium | Ge | H ₂ O/0.16% F- | N9303774 | N9300120 | N9303739 |
| Gold | Au | 10% HCl | N9303759 | N9300121 | N9303728 |
| Hafnium | Hf | 2% HCl | | N9303775 | N9300122 |
| Holmium | Ho | 2% HNO ₃ | N9303776 | N9300123 | |
| Indium | In | 2% HNO ₃ | N9303777 | N9300124 | N9303741 |

Pure Grade Standards for AA and ICP-OES

- Analyzed by ICP-OES
- Analyzed by Classical Wet Assay
- 32 trace impurities analyzed by ICP-MS of the final solution and reported on the certificate
- Impurities reported at ppm level
- All Standards are prepared and certified under ISO Guide 34 and ISO 17025



Pure Plus Grade Standards for ICP-MS

- Analyzed by ICP-OES
- Analyzed by Classical Wet Assay
- 67 trace impurities analyzed by ICP-MS of the final solution and reported on the certificate
- Impurities reported at ppb level
- All Standards are prepared and certified under ISO Guide 34 and ISO 17025

Single-Element Standards – 1,000 µg/mL (con't)

| Element | Symbol | Matrix | Pure Grade 125 mL Part No. | Pure Grade 500 mL Part No. | Pure Plus Grade 125 mL Part No. |
|--------------|--------|--------------------------|----------------------------------|----------------------------------|---------------------------------------|
| Iridium | Ir | 10% HCl | N9303778 | N9300125 | |
| Iron | Fe | 2% HNO ₃ | N9303771 | N9300126 | N9303738 |
| Lanthanum | La | 2% HNO ₃ | N9303780 | N9300127 | |
| Lead | Pb | 2% HNO ₃ | N9300175 | N9300128 | N9303748 |
| Lithium | Li | 2% HNO ₃ | N9303781 | N9300129 | |
| Lutetium | Lu | 2% HNO ₃ | N9303782 | N9300130 | |
| Magnesium | Mg | 2% HNO ₃ | N9300179 | N9300131 | N9303743 |
| Manganese | Mn | 2% HNO ₃ | N9303783 | N9300132 | N9303744 |
| Mercury | Hg | 10% HNO ₃ | N9300174 | N9300133 | N9303740 |
| Molybdenum | Mo | H ₂ O | N9303784 | N9300134 | N9303745 |
| Neodymium | Nd | 2% HNO ₃ | N9303787 | N9300135 | |
| Nickel | Ni | 2% HNO ₃ | N9300177 | N9300136 | N9303747 |
| Niobium | Nb | H ₂ O/0.4% HF | N9303786 | N9300137 | |
| Palladium | Pd | 10% HCl | N9303789 | N9300138 | |
| Phosphorus | P | H ₂ O | N9303788 | N9300139 | |
| Platinum | Pt | 10% HCl | N9303791 | N9300140 | |
| Potassium | K | 2% HNO ₃ | N9303779 | N9300141 | N9303742 |
| Praseodymium | Pr | 2% HNO ₃ | N9303790 | N9300142 | |
| Rhenium | Re | H ₂ O | N9303793 | N9300143 | |
| Rhodium | Rh | 10% HCl | N9303794 | N9300144 | N9303749 |
| Rubidium | Rb | 2% HNO ₃ | N9303792 | N9300145 | |
| Ruthenium | Ru | 10% HCl | N9303795 | N9300146 | |
| Samarium | Sm | 2% HNO ₃ | N9303800 | N9300147 | |
| Scandium | Sc | 2% HNO ₃ | N9303798 | N9300148 | N9303751 |
| Selenium | Se | 2% HNO ₃ | N9300182 | N9300149 | N9303752 |

Single-Element Standards – 1,000 µg/mL (con't)

| Element | Symbol | Matrix | Pure Grade 125 mL Part No. | Pure Grade 500 mL Part No. | Pure Plus Grade 125 mL Part No. |
|-----------|--------|---------------------------|----------------------------------|----------------------------------|---------------------------------------|
| Silicon | Si | H ₂ O | N9303799 | N9300150 | |
| Silver | Ag | 2% HNO ₃ | N9300171 | N9300151 | N9303725 |
| Sodium | Na | 2% HNO ₃ | N9303785 | N9300152 | N9303746 |
| Strontium | Sr | 2% HNO ₃ | N9303802 | N9300153 | |
| Sulfur | S | H ₂ O | N9303796 | N9300154 | |
| Tantalum | Ta | H ₂ O/0.8% HF | N9303803 | N9300155 | |
| Tellurium | Te | 5% HNO ₃ | N9303805 | N9300156 | |
| Terbium | Tb | 2% HNO ₃ | N9303804 | N9300157 | N9303753 |
| Tin | Sn | 20% HCl | N9303801 | N9300161 | N9303838 |
| Thallium | Tl | 2% HNO ₃ | N9300170 | N9300158 | N9303755 |
| Thorium | Th | 2% HNO ₃ | N9303842 | | |
| Thulium | Tm | 2% HNO ₃ | N9303807 | N9300160 | |
| Titanium | Ti | H ₂ O/0.24% F- | N9303806 | N9300162 | N9303754 |
| Tungsten | W | H ₂ O | N9303809 | N9300163 | |
| Uranium | U | 2% HNO ₃ | N9303844 | | |
| Vanadium | V | 2% HNO ₃ | N9303808 | N9300165 | N9303756 |
| Ytterbium | Yb | 2% HNO ₃ | N9303811 | N9300166 | |
| Yttrium | Y | 2% HNO ₃ | N9303810 | N9300167 | N9303757 |
| Zinc | Zn | 2% HNO ₃ | N9300178 | N9300168 | N9303758 |
| Zirconium | Zr | 2% HNO ₃ | N9303812 | N9300169 | |

Single-Element Standards – 1 µg/mL

| Element | Symbol | Matrix | Pure Grade 125 mL Part No. |
|-----------|--------|---|----------------------------------|
| Aluminum | Al | 2% HCl | N9304200 |
| Aluminum | Al | 2% HNO ₃ | N9304201 |
| Antimony | Sb | 2% HCl | N9304202 |
| Antimony | Sb | H ₂ O/Tr.HNO ₃ /Tr.Tart | N9304203 |
| Arsenic | As | 2% HCl | N9304204 |
| Arsenic | As | 2% HNO ₃ | N9304205 |
| Barium | Ba | 2% HCl | N9304206 |
| Barium | Ba | 2% HNO ₃ | N9304207 |
| Beryllium | Be | 2% HNO ₃ | N9304208 |
| Bismuth | Bi | 2% HNO ₃ | N9304209 |
| Boron | B | H ₂ O | N9304210 |
| Cadmium | Cd | 2% HCl | N9304211 |
| Cadmium | Cd | 2% HNO ₃ | N9304212 |
| Calcium | Ca | 2% HCl | N9304213 |
| Calcium | Ca | 2% HNO ₃ | N9304214 |
| Carbon | C | H ₂ O | N9304215 |
| Cerium | Ce | 2% HNO ₃ | N9304216 |
| Cesium | Cs | 2% HNO ₃ | N9304217 |
| Chromium | Cr | 2% HCl | N9304218 |
| Chromium | Cr | 2% HNO ₃ | N9304219 |
| Chromium | Cr | H ₂ O | N9304220 |

Single-Element Standards – 1 µg/mL (con't)

| Element | Symbol | Matrix | Pure Grade 125 mL Part No. |
|--------------|--------|------------------------|----------------------------------|
| Cobalt | Co | 2% HCl | N9304221 |
| Cobalt | Co | 2% HNO ₃ | N9304222 |
| Copper | Cu | 2% HCl | N9304223 |
| Copper | Cu | 2% HNO ₃ | N9304224 |
| Dysprosium | Dy | 2% HNO ₃ | N9304225 |
| Erbium | Er | 2% HNO ₃ | N9304226 |
| Europium | Eu | 2% HNO ₃ | N9304227 |
| Gadolinium | Gd | 2% HNO ₃ | N9304228 |
| Gallium | Ga | 2% HNO ₃ | N9304229 |
| Germanium | Ge | H ₂ O | N9304230 |
| Gold | Au | 2% HCl | N9304231 |
| Hafnium | Hf | 2% HCl | N9304232 |
| Holmium | Ho | 2% HNO ₃ | N9304233 |
| Indium | In | 2% HNO ₃ | N9304234 |
| Iridium | Ir | 2% HCl | N9304235 |
| Iron | Fe | 2% HCl | N9304236 |
| Iron | Fe | 2% HNO ₃ | N9304237 |
| Lanthanum | La | 2% HNO ₃ | N9304238 |
| Lead | Pb | 2% HNO ₃ | N9304239 |
| Lithium | Li | 2% HCl | N9304240 |
| Lithium | Li | 2% HNO ₃ | N9304241 |
| Lutetium | Lu | 2% HNO ₃ | N9304242 |
| Magnesium | Mg | 2% HCl | N9304243 |
| Magnesium | Mg | 2% HNO ₃ | N9304244 |
| Manganese | Mn | 2% HNO ₃ | N9304245 |
| Potassium | K | 2% HCl | N9304247 |
| Potassium | K | 2% HNO ₃ | N9304248 |
| Molybdenum | Mo | H ₂ O | N9304249 |
| Niobium | Nb | H ₂ O/tr HF | N9304250 |
| Neodymium | Nd | 2% HNO ₃ | N9304251 |
| Nickel | Ni | 2% HNO ₃ | N9304252 |
| Palladium | Pd | 2% HCl | N9304253 |
| Phosphorus | P | H ₂ O | N9304254 |
| Platinum | Pt | 2% HCl | N9304255 |
| Praseodymium | Pr | 2% HNO ₃ | N9304256 |
| Rubidium | Rb | 2% HNO ₃ | N9304257 |
| Rhenium | Re | H ₂ O | N9304258 |
| Rhodium | Rh | 2% HCl | N9304259 |
| Ruthenium | Ru | 2% HCl | N9304260 |
| Samarium | Sm | 2% HNO ₃ | N9304261 |
| Scandium | Sc | 2% HNO ₃ | N9304262 |
| Selenium | Se | 2% HNO ₃ | N9304263 |
| Silicon | Si | H ₂ O/tr HF | N9304264 |
| Silver | Ag | 2% HNO ₃ | N9304265 |
| Sodium | Na | 2% HCl | N9304266 |

Single-Element Standards – 1 µg/mL (con't)

| Element | Symbol | Matrix | Pure Grade 125 mL Part No. |
|-----------|--------|----------------------------|----------------------------------|
| Sodium | Na | 2% HNO ₃ | N9304267 |
| Strontium | Sr | 2% HCl | N9304268 |
| Strontium | Sr | 2% HNO ₃ | N9304269 |
| Sulfur | S | H ₂ O | N9304270 |
| Tantalum | Ta | H ₂ O/tr HF | N9304271 |
| Tellurium | Te | 5% HCl | N9304272 |
| Tellurium | Te | 2% HNO ₃ | N9304273 |
| Terbium | Tb | 2% HNO ₃ | N9304274 |
| Thallium | Tl | 2% HNO ₃ | N9304275 |
| Thorium | Th | 2% HNO ₃ | N9304276 |
| Thulium | Tm | 2% HNO ₃ | N9304277 |
| Tin | Sn | 5% HCl | N9304278 |
| Tin | Sn | 2% HNO ₃ /tr HF | N9304279 |
| Titanium | Ti | H ₂ O/tr HF | N9304280 |
| Tungsten | W | 2% HNO ₃ /tr HF | N9304281 |
| Tungsten | W | H ₂ O | N9304282 |
| Uranium | U | 2% HNO ₃ | N9304283 |
| Vanadium | V | 2% HCl | N9304284 |
| Vanadium | V | 2% HNO ₃ | N9304285 |
| Ytterbium | Yb | 2% HNO ₃ | N9304286 |
| Yttrium | Y | 2% HNO ₃ | N9304287 |
| Zinc | Zn | 2% HCl | N9304288 |
| Zinc | Zn | 2% HNO ₃ | N9304289 |
| Zirconium | Zr | 2% HCl | N9304290 |
| Zirconium | Zr | 2% HNO ₃ | N9304291 |

Single-Element Pure Plus Standards - 10 µg/mL

| Element | Symbol | Matrix | Pure Plus Grade 125 mL Part No. |
|-----------|--------|------------------------|---------------------------------------|
| Bismuth | Bi | 2% HNO ₃ | N9303731 |
| Germanium | Ge | H ₂ O tr HF | N9303739 |
| Indium | In | 2% HNO ₃ | N9303741 |
| Rhodium | Rh | 2% HCl | N9303749 |
| Scandium | Sc | 2% HNO ₃ | N9303751 |
| Terbium | Tb | 2% HNO ₃ | N9303753 |
| Yttrium | Y | 2% HNO ₃ | N9303757 |

Single-Element Pure Standards - 10,000 µg/mL

| Element | Symbol | Matrix | Pure Grade 125 mL Part No. | Pure Grade 500 mL Part No. |
|----------|--------|--|----------------------------------|----------------------------------|
| Aluminum | Al | 5% HNO ₃ | N9304111 | N9304110 |
| Antimony | Sb | 20% HCl | | N9304292 |
| Antimony | Sb | H ₂ O/Tartaric Acid/Tr HNO ₃ | N9304294 | |
| Arsenic | As | 5% HNO ₃ | N9304295 | N9304296 |

Single-Element Pure Standards - 10,000 µg/mL (con't)

| Element | Symbol | Matrix | Pure Grade 125 mL Part No. | Pure Grade 500 mL Part No. |
|------------|--------|----------------------------|----------------------------------|----------------------------------|
| Barium | Ba | 5% HNO ₃ | N9304297 | N9304298 |
| Beryllium | Be | 5% HNO ₃ | N9304299 | N9304300 |
| Boron | B | H ₂ O | N9304301 | N9304302 |
| Cadmium | Cd | 5% HNO ₃ | N9304303 | N9304304 |
| Calcium | Ca | 5% HNO ₃ | N0691581 | N9303764 |
| Cerium | Ce | 5% HNO ₃ | N9304305 | N9304306 |
| Cesium | Cs | 5% HNO ₃ | N9304307 | N9304308 |
| Chromium | Cr | 2% HNO ₃ | N9304309 | N9304311 |
| Chromium | Cr | 5% HCl | | N9304310 |
| Chromium | Cr | H ₂ O | | N9304312 |
| Cobalt | Co | 5% HNO ₃ | N9304313 | N9304314 |
| Copper | Cu | 5% HNO ₃ | N9304112 | N9300283 |
| Erbium | Er | 5% HNO ₃ | | N9304315 |
| Gadolinium | Gd | 5% HNO ₃ | N9304316 | N9304317 |
| Iron | Fe | 5% HNO ₃ | N9304113 | N9307117 |
| Lanthanum | La | 5% HNO ₃ | N9304318 | N9304319 |
| Lead | Pb | 5% HNO ₃ | N9304321 | N9304320 |
| Lithium | Li | 5% HCl | | N9304322 |
| Lithium | Li | 5% HNO ₃ | N9304323 | N9304324 |
| Magnesium | Mg | 5% HNO ₃ | N0691745 | N9304114 |
| Manganese | Mn | 5% HNO ₃ | N9304115 | |
| Mercury | Hg | 10% HNO ₃ | N9304325 | N9304326 |
| Molybdenum | Mo | H ₂ O | N9304327 | N9304328 |
| Nickel | Ni | 5% HNO ₃ | N9304117 | N9304116 |
| Niobium | Nb | H ₂ O | | N9304329 |
| Niobium | Nb | H ₂ O/tr HF | N9304330 | |
| Phosphorus | P | H ₂ O | N9304119 | N9304118 |
| Potassium | K | 5% HNO ₃ | N9304121 | N9304120 |
| Rubidium | Rb | 2% HNO ₃ | N9304331 | N9304332 |
| Scandium | Sc | 2% HNO ₃ | N9304333 | |
| Scandium | Sc | 5% HNO ₃ | N9304334 | |
| Selenium | Se | 5% HNO ₃ | N9304335 | N9304336 |
| Silicon | Si | H ₂ O/4% F- | N9304122 | |
| Silver | Ag | 5% HNO ₃ | N9304337 | N9304338 |
| Sodium | Na | 5% HNO ₃ | N9304124 | N9304123 |
| Strontium | Sr | 5% HCl | N9304339 | |
| Strontium | Sr | 5% HNO ₃ | N9304340 | N9304341 |
| Sulfur | S | H ₂ O | N9304126 | N9304125 |
| Tantalum | Ta | H ₂ O | | N9304342 |
| Tantalum | Ta | H ₂ O/tr HF | N9304343 | |
| Tin | Sn | HNO ₃ /2% HF | | N9304344 |
| Tin | Sn | 20% HCl | N9304345 | N9304346 |
| Titanium | Ti | 40% HCl | | N9304347 |
| Titanium | Ti | H ₂ O | N9304348 | N9304349 |
| Tungsten | W | 2% HNO ₃ /5% HF | | N9304350 |

Single-Element Pure Standards - 10,000 µg/mL (con't)

| Element | Symbol | Matrix | Pure Grade 125 mL Part No. | Pure Grade 500 mL Part No. |
|-----------|--------|----------------------|----------------------------------|----------------------------------|
| Tungsten | W | H ₂ O | N9304351 | N9304352 |
| Uranium | U | 5% HNO ₃ | N9304353 | N9304354 |
| Vanadium | V | 15% HCl | | N9304355 |
| Vanadium | V | 15% HNO ₃ | N9304356 | N9304357 |
| Yttrium | Y | 5% HNO ₃ | N9304128 | N9304127 |
| Zinc | Zn | 5% HNO ₃ | N9304129 | |
| Zirconium | Zr | 10% HCl | | N9304358 |
| Zirconium | Zr | 5% HNO ₃ | N9304359 | N9304360 |

STANDARDS FOR ALL YOUR LABORATORY NEEDS

Our go-to multi-element standards are suitable for your daily laboratory needs. Spanning across a wide range of applications and methods, you'll find the right solution to help you achieve laboratory success.

Multi-Element Standards

| Matrix | Contents | Vol. | Part No. |
|-----------------------------------|--|--------|----------|
| Multi-Element Solution | | | |
| 5% HNO ₃ | 1,000 µg/mL: Al, Ca, Fe, Mg | 500 mL | N9307113 |
| Multi-Element Solution | | | |
| 5% HNO ₃ | 1,000 µg/mL: K, Na, P | 500 mL | N9307114 |
| Multi-Element Solution | | | |
| 5% HNO ₃ | 1,000 µg/mL: Mo, Sb, Sn, W, Zr | 500 mL | N9307115 |
| Multi-Element Solution | | | |
| 5% HNO ₃ | 1,000 µg/mL: As, Ba, Be, Cd, Cr, Co, Cu, La, Pb, Li, Mn, Ni, Sc, Sr, V, Y, Zn | 500 mL | N9307116 |
| 5% HNO ₃ / trace HF | 100 µg/mL: Ge, Mo, S, Si, Ti | 125 mL | N9308541 |
| 20% HCl/ 1% HNO ₃ | 100 µg/mL: Au, Cr, Sb, Sn, Te | 125 mL | N9308542 |
| 5% HNO ₃ | 100 µg/mL: Ag, As, B, Ba, Be, Bi, Ca, Cd, Co, Cu, Fe, K, Li, Mg, Mn, Na, Ni, P, Pb, Se, Sr, Tl, U, V, Zn | 125 mL | N9308543 |
| Multi-Element Solution 1 | | | |
| 2% HNO ₃ | 10 µg/mL: Be, Bi, Ce, Co, In, Mg, Ni, Pb, U | 125 mL | N9300231 |
| Multi-Element Solution 2 | | | |
| 5% HNO ₃ | 10 µg/mL: Ce, Dy, Er, Eu, Gd, Ho, La, Lu, Nd, Pr, Sc, Sm, Tb, Th, Tm, Y, Yb | 125 mL | N9300232 |

Multi-Element Standards (con't)

| Matrix | Contents | Vol. | Part No. |
|--|--|--------|----------|
| Multi-Element Solution 3 | | | |
| 5% HNO ₃ | 10 µg/mL: Ag, Al, As, Ba, Be, Bi, Ca, Cd, Co, Cr, Cs, Cu, Fe, Ga, Hg*, In, K, Li, Mg, Mn, Na, Ni, Pb, Rb, Se, Sr, Tl, U, V, Zn *Supplied in separate bottle. | 125 mL | N9300233 |
| Multi-Element Solution 3 without Mercury | | | N9301720 |
| Multi-Element Solution 4 | | | |
| 10% HCl/1% HNO ₃ | 10 µg/mL: Au, Hf, Ir, Pd, Pt, Rh, Ru, Sb, Sn, Te | 125 mL | N9300234 |
| Multi-Element Solution 5 | | | |
| H ₂ O/tr HF/ tr HNO ₃ | 10 µg/mL: B, Ge, Mo, Nb, P, Re, S, Si, Ta, Ti, W, Zr | 125 mL | N9300234 |
| Set of Multi-Element Solutions | | | |
| Includes: (1 bottle of each) | | | N9300236 |
| | Multi-Element Solution 2 | 125 mL | N9300232 |
| | Multi-Element Solution 3 | 125 mL | N9300233 |
| | Multi-Element Solution 4 | 125 mL | N9300234 |
| | Multi-Element Solution 5 | 125 mL | N9300235 |
| | Water Blank | 125 mL | N9303814 |
| | Hydrochloric Acid Blank | 125 mL | N9300238 |
| | 2% Nitric Acid Blank | 125 mL | N9300239 |
| PerkinElmer Pure I | | | |
| 5% HNO ₃ | 400 µg/mL: Tl 200 µg/mL: Bi, In, Pb 150 µg/mL: Ga 100 µg/mL: Al 50 µg/mL: Ag, Ni 25 µg/mL: Cr 20 µg/mL: Cd, Co, Cu, Zn 15 µg/mL: B, Fe 5 µg/mL: Ba, Mn 1 µg/mL: Be, Sr | 125 mL | N9303940 |
| PerkinElmer Pure IV (Quality Control Standard 23) | | | |
| 10% HNO ₃ | 1,000 µg/mL: Ag, Al, B, Ba, Bi, Ca, Cd, Co, Cr, Cu, Fe, Ga, In, K, Li, Mg, Mn, Na, Ni, Pb, Sr, Tl, Zn | 125 mL | N9303941 |
| PerkinElmer Pure VIII | | | |
| 5% HNO ₃ | 100 µg/mL: Al, B, Ba, Be, Bi, Ca, Cd, Co, Cr, Cu, Fe, Ga, K, Li, Mg, Mn, Na, Ni, Pb, Se, Sr, Te, Tl, Zn | 125 mL | N9303942 |
| PerkinElmer Pure IX | | | |
| 5% HNO ₃ | 100 µg/mL: As, Be, Pb, Cd | 125 mL | N9303943 |
| PerkinElmer Pure X | | | |
| 2% HNO ₃ | 35,000 µg/mL: Ca 15,000 µg/mL: Mg 8,000 µg/mL: Na 3,000 µg/mL: K 100 µg/mL: B, Fe, Mo, Sr 50 µg/mL: As, Ba, Ni, V, Zn 30 µg/mL: Mn 25 µg/mL: Co, Pb 20 µg/mL: Be, Cd, Cr, Cu 10 µg/mL: Bi, Se, Tl 8 µg/mL Mercury in 5% HNO ₃ | 125 mL | N9303944 |

Multi-Element Standards (con't)

| Matrix | Contents | Vol. | Part No. |
|---|---|--------|-----------------|
| 8 µg/mL Mercury in 5% HNO₃ | | | |
| 5% HNO ₃ | 8 µg/mL: Hg | 125 mL | N9303954 |
| PerkinElmer Pure XI | | | |
| 5% HNO ₃ | 2,500 µg/mL: Zn 900 µg/mL: Cr, Pb 800 µg/mL: Cu 200 µg/mL: Ni 10 µg/mL: Cd | 125 mL | N9303945 |
| 5 µg/mL Mercury in 5% HNO₃ | | | |
| 5% HNO ₃ | 5 µg/mL: Hg in 5% HNO ₃ | 125 mL | N9303949 |
| PerkinElmer Pure XIII | | | |
| 5% HNO ₃ | 500 µg/mL: Al 250 µg/mL: V 100 µg/mL: As, Be, Co, Cr, Cu, Fe, Mn, Ni, Pb, Zn 25 µg/mL: Cd, Se | 125 mL | N9303946 |
| PerkinElmer Pure XVI (Quality Control Standard, 21 Elements) | | | |
| 5% HNO ₃ / tr Tartaric Acid/ tr HF | 100 µg/mL: As, Be, Ca, Cd, Co, Cr, Cu, Fe, Li, Mg, Mn, Mo, Ni, Pb, Sb, Se, Sr, Ti, Tl, V, Zn | 125 mL | N9300281 |
| PerkinElmer Pure XVII | | | |
| 15% HCl/ trace HF | 100 µg/mL: Hf, Ir, Sb, Sn, Ta, Tl, Zr | 125 mL | N9303948 |
| PerkinElmer Pure VI | | | |
| 1 mol/L HNO ₃ / tr Tartaric Acid | 10 µg/mL: Ag, Al, Ba, Bi, Cd, Co, Cr, Cu, Ga, K, Li, Mg, Mn, Mo, Na, Ni, Pb, Rb, Sr, Te, Tl, U, V 100 µg/mL: As, B, Be, Fe, Se, Zn 1000 µg/mL: Ca | 125 mL | N9307741 |

Mixed Calibration Standards

| Matrix | Contents | Vol. | Part No. |
|-------------------------------------|--|--------|-----------------|
| Mixed Calibration Standard | | | |
| 2% HNO ₃ | 50 µg/mL: As, K 10 µg/mL: La, Li, Mn, Ni, Sr, Zn 1 µg/mL: Ba, Mg | 500 mL | N0691579 |
| Mixed Calibration Standard 1 | | | |
| 2% HNO ₃ | 500 µg/mL: Pb 200 µg/mL: Se 150 µg/mL: Cd, Zn 100 µg/mL: Mn 50 µg/mL: Be | 125 mL | N9300200 |
| Mixed Calibration Standard 2 | | | |
| 5% HNO ₃ | 10,000 µg/mL: Fe 100 µg/mL: Ba, Co, Cu, V | 125 mL | N9300201 |
| Mixed Calibration Standard 3 | | | |
| 2% HNO ₃ / tr HF | 500 µg/mL: As 100 µg/mL: Mo, Si | 125 mL | N9300202 |
| Mixed Calibration Standard 4 | | | |
| 5% HNO ₃ | 1,000 µg/mL: Ca 400 µg/mL: K 200 µg/mL: Al, Na 20 µg/mL: Cr, Ni | 125 mL | N9300203 |

Mixed Calibration Standards (con't)

| Matrix | Contents | Vol. | Part No. |
|---|--|--------|-----------------|
| Mixed Calibration Standard 5 | | | |
| 5% HNO ₃ tr Tartaric Acid/ tr HF | 1,000 µg/mL: Mg 200 µg/mL: Sb, Tl 100 µg/mL: B 50 µg/mL: Ag | 125 mL | N9300204 |

Spike Standards

| Matrix | Contents | Vol. | Part No. |
|---|--|--------|-----------------|
| Spike Sample Standard I | | | |
| 5% HNO ₃ tr Tartaric Acid/ tr HF | 200 µg/mL: Al, As, Ba, Se, Tl 100 µg/mL: Fe 50 µg/mL: Co, Mn, Ni, Pb, Sb, V, Zn | 125 mL | N9300230 |
| Spike Sample Standard I (water) | | | |
| 5% HNO ₃ tr Tartaric Acid/ tr HF | 500 µg/mL: Fe 250 µg/mL: Ba, Zn 100 µg/mL: Co, Cr, Cu, Mn, Ni, Sb, V 50 µg/mL: As, Pb 25 µg/mL: Ag, Be, Cd, Se, Tl | 125 mL | N9303839 |
| Spike Sample Standard 2 (soil) | | | |
| 5% HNO ₃ tr Tartaric Acid/ tr HF | 250 µg/mL: Ba, Cr, Cu, Zn 150 µg/mL: V 125 µg/mL: Ni 100 µg/mL: Co, Pb, Sb 50 µg/mL: As, Cd 25 µg/mL: Ag, Be, Se, Tl | 125 mL | N9303840 |
| Spike Sample Standard 3 (for ILM 05.2) | | | |
| 5% HNO ₃ tr Tartaric Acid/ tr HF | 200 µg/mL: Al, Ba 50 µg/mL: Co, Mn, Ni, V, Zn 25 µg/mL: Cu 20 µg/mL: Cr 10 µg/mL: Sb 5 µg/mL: Ag, Be, Cd, Tl 4 µg/mL: As 2 µg/mL: Pb 1 µg/mL: Se | 125 mL | N9303841 |

Quality Control Standards

| Matrix | Contents | Vol. | Part No. |
|--|--|--------|-----------------|
| Quality Control Standard 1A | | | |
| 5% HNO ₃ /tr Tartaric Acid HF | 1,000 µg/mL: Sb, Ti | 125 mL | N9304130 |
| Quality Control Standard 1B | | | |
| 10% HNO ₃ | 1,000 µg/mL: As, Be, Ca, Cd, Co, Cr, Cu, Fe, Li, Mg, Mn, Mo, Ni, Pb, Se, Sr, Ti, Tl, V, Zn | 125 mL | N9304131 |
| Quality Control Standard, 21 Elements Pure (Pure XVI) | | | |
| 5% HNO ₃ / tr Tartaric Acid/ tr HF | 100 µg/mL: As, Be, Ca, Cd, Co, Cr, Cu, Fe, Li, Mg, Mn, Mo, Ni, Pb, Sb, Se, Sr, Ti, Tl, V, Zn | 125 mL | N9300281 |
| Quality Control Standard, 21 Elements Pure Plus | | | |
| 5% HNO ₃ / tr Tartaric Acid/ tr HF | 100 µg/mL: As, Be, Ca, Cd, Co, Cr, Cu, Fe, Li, Mg, Mn, Mo, Ni, Pb, Sb, Se, Sr, Ti, Tl, V, Zn | 125 mL | N9303837 |
| Quality Control Standard, 7A Elements | | | |
| 5% HNO ₃ / tr HF | 1,000 µg/mL: K 500 µg/mL: Si 100 µg/mL: Al, B, Ba, Na 50 µg/mL: Ag | 125 mL | N9300280 |

MATRIX MODIFIERS AND AA TEST MIXES



We offer standards specifically for your Atomic Absorption (AA) instrument. From mixed standards to reagents, we have what you need for your AA analysis.

GFAAS Mixed Standard

| Matrix | Contents | Vol. | Part No. |
|-----------------------------------|--|--------|-----------------|
| 5% HNO ₃ w/trace HF | 100 µg/mL: Al, As, Pb, Sb, Se, Tl 50 µg/mL: Ba, Co, Cu, Ni 20 µg/mL: Cr, Fe, Mn 10 µg/mL: Ag 5 µg/mL: Be, Cd | 125 mL | N9300244 |

AA Test Mix

| Matrix | Contents | Vol. | Part No. |
|--------|---|--------|-----------------|
| 2% HCl | 50 µg/mL: Ca, Cr, Cu, Fe, Ni 20 µg/mL: K 10 µg/mL: Na, Zn | 125 mL | 02900540 |

Matrix Modifiers for Graphite Furnace AA

| Matrix | Contents | Vol. | Part No. |
|--|--|--------|-----------------|
| Mg(NO ₃) ₂ | 1% Mg (NO ₃) ₂ (as nitrate) | 100 mL | B0190634 |
| Pd | 1% Pd (as nitrate) | 50 mL | B0190635 |
| NH ₄ H ₂ PO ₄ | 10% NH ₄ H ₂ PO ₄ | 100 mL | N9303445 |

Reagents

| Description | Vol. | Part No. |
|-------------------------------|--------|-----------------|
| Triton® X-100 Wetting Agent | 100 mL | N9300260 |
| Antifoaming Silicone Emulsion | 500 mL | B0507226 |
| Glycerol | 1 L | B3141064 |

Order your FREE PerkinElmer Pure Standards Periodic Table Poster

Our standards periodic table poster is a great addition to any lab. Aside from its modern design,

we provide you with more than just a table of elements. In order to make a better periodic table, we highlighted all the elements for which we offer standards for, increasing the functionality and utility of the poster.

Go to www.perkinelmer.com/periodic and fill out the form to receive your standards periodic table poster.

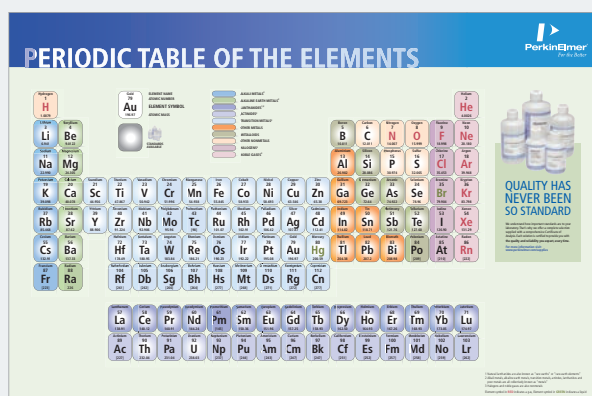

ENVIRONMENTAL ANALYSIS STANDARDS



We offer a variety of environmental analysis standards for all your environmental application needs.

Environmental Method Sets

| Matrix | Contents | Vol. | Part No. |
|--|---|--------|-----------------|
| Environmental Standard Kit for NexION Standard Mode | | | N9307118 |
| 1 bottle each: | | | |
| 5% HNO ₃ | 1,000 µg/mL: Ca, K, Mg, Na | 125 mL | N9307805 |
| 5% HNO ₃ | 1,000 µg/mL: Al, Fe | 125 mL | N9307806 |
| 5% HNO ₃ / tr Tartaric Acid/ tr HF | 100 µg/mL: Ag, Al, As, Ba, Be, Ca, Cd, Co, Cr, Cu, Fe, K, Mg, Mn, Mo, Na, Ni, Pb, Sb, Se, Sn, Sr, Ti, Tl, V, Zn | 125 mL | N9301721 |
| 2% HNO ₃ | 100 µg/mL: B, Th, U | 125 mL | N9307807 |
| 5% HNO ₃ | 10 µg/mL: Hg | 125 mL | N9300253 |
| 2% HNO ₃ | 50 µg/mL: Sc, Ge 10 µg/mL: Rh, In, Tb | 125 mL | N9308591 |
| Environmental Standard Kit for NexION KED/DRC Mode | | | N9307119 |
| 1 bottle each: | | | |
| 5% HNO ₃ | 1,000 µg/mL: Ca, K, Mg, Na | 125 mL | N9307805 |
| 5% HNO ₃ | 1,000 µg/mL: Al, Fe | 125 mL | N9307806 |
| 5% HNO ₃ / tr Tartaric Acid/ tr HF | 100 µg/mL: Ag, Al, As, Ba, Be, Ca, Cd, Co, Cr, Cu, Fe, K, Mg, Mn, Mo, Na, Ni, Pb, Sb, Se, Sn, Sr, Ti, Tl, V, Zn | 125 mL | N9301721 |
| 2% HNO ₃ | 100 µg/mL: B, Th, U | 125 mL | N9307807 |
| 5% HNO ₃ | 10 µg/mL: Hg | 125 mL | N9300253 |
| 2% HNO ₃ | 100 µg/mL: Sc 50 µg/mL: Ge 1 µg/mL: Rh, In, Tb | 125 mL | N9308592 |

Environmental Method Sets (con't)

| Matrix | Contents | Vol. | Part No. |
|---|--|--------|-----------------|
| Environmental Standard Kit for ELAN non-DRC/ Standard ICP-MS Instruments | | | N9307111 |
| 1 bottle each: | | | |
| 5% HNO ₃ | 1,000 µg/mL: Ca, K, Mg, Na | 125 mL | N9307805 |
| 5% HNO ₃ | 1,000 µg/mL: Al, Fe | 125 mL | N9307806 |
| 5% HNO ₃ / tr Tartaric Acid/ tr HF | 100 µg/mL: Ag, Al, As, Ba, Be, Ca, Cd, Co, Cr, Cu, Fe, K, Mg, Mn, Mo, Na, Ni, Pb, Sb, Se, Sn, Sr, Ti, Tl, V, Zn | 125 mL | N9301721 |
| 2% HNO ₃ | 100 µg/mL: B, Th, U | 125 mL | N9307807 |
| 5% HNO ₃ | 10 µg/mL: Hg | 125 mL | N9300253 |
| Internal Standard Mix | | | |
| 5% HNO ₃ / tr HCL | 50 µg/mL: Sc 20 µg/mL: Ge 10 µg/mL: In, Ir, Li6, Rh, Tb, Y | 125 mL | N9307808 |
| Environmental Standard Kit for ELAN DRC Instruments | | | N9307112 |
| 1 bottle each: | | | |
| 5% HNO ₃ | 1,000 µg/mL: Ca, K, Mg, Na | 125 mL | N9307805 |
| 5% HNO ₃ | 1,000 µg/mL: Al, Fe | 125 mL | N9307806 |
| 5% HNO ₃ / tr Tartaric Acid/ tr HF | 100 µg/mL: Ag, Al, As, Ba, Be, Ca, Cd, Co, Cr, Cu, Fe, K, Mg, Mn, Mo, Na, Ni, Pb, Sb, Se, Sn, Sr, Ti, Tl, V, Zn | 125 mL | N9301721 |
| 2% HNO ₃ | 100 µg/mL: B, Th, U | 125 mL | N9307807 |
| 5% HNO ₃ | 10 µg/mL: Hg | 125 mL | N9300253 |
| 5% HNO ₃ / tr HCL | Internal Standard Mix 200 µg/mL: Sc 20 µg/mL: Ga 10 µg/mL: In, Ir, Rh, Tm | 125 mL | N9307738 |
| Contract Lab Program Modification Set | | | N9307103 |
| 1 bottle each: | | | |
| 2% HNO ₃ / 5% HCl | 10 µg/mL: Ba, Be, Ce, Co, In, Li, Mg, Pb, Rh, Tl, U, Y | 125 mL | N9303843 |
| 2% HNO ₃ / tr Tartaric Acid/ tr HF | 20 µg/mL: Ag, Al, As, Ba, Be, Cd, Co, Cr, Cu, Mn, Mo, Ni, Pb, Sb, Se, Th, Tl, U, V, Zn | 125 mL | N9303816 |
| 5% HNO ₃ / tr Tartaric Acid/ tr HF | 100 µg/mL: Ag, Al, As, Ba, Be, Ca, Cd, Co, Cr, Cu, Fe, K, Mg, Mn, Mo, Na, Ni, Pb, Sb, Se, Sn, Sr, Ti, Tl, V, Zn | 125 mL | N9301721 |
| 5% HNO ₃ / tr Tartaric Acid | 500 µg/mL: Ca, K, Mg, Na 20 µg/mL: Al, Ba 10 µg/mL: Fe 6 µg/mL: Sb 5 µg/mL: Co, V 4 µg/mL: Ni 2.5 µg/mL: Cu 2 µg/mL: Zn 1.5 µg/mL: Mn 1 µg/mL: Ag, As, Cr, Tl 0.5 µg/mL: Be, Cd, Se 0.3 µg/mL: Pb | 125 mL | N9303819 |
| 2% HNO ₃ / tr Tartaric Acid/ tr HF | 10 µg/mL: Ag, Al, As, Ba, Be, Cd, Co, Cr, Cu, Mn, Ni, Pb, Sb, Se, Tl, V, Zn | 125 mL | N9303821 |
| 5% HNO ₃ | 10 µg/mL: Hg | 125 mL | N9300253 |
| 2% HNO ₃ | 200 µg/mL: Ca, Fe, K, Mg, Na | | N9303822 |
| 2% HNO ₃ | 10 µg/mL: Mo, Th, U | | N9303823 |
| 2% HNO ₃ / tr HF | 10 µg/mL: Mo, Sn, Sr, Ti | 125 mL | N9303824 |

Environmental Method Sets (con't)

| Matrix | Contents | Vol. | Part No. |
|---|--|--------|-----------------|
| 5% HNO ₃ / tr HF | 21,215 µg/mL: Cl 3,000 µg/mL: Ca 2,500 µg/mL: Fe, Na 2,000 µg/mL: C 1,000 µg/mL: Al, K, Mg, P, S 20 µg/mL: Mo, Ti | 125 mL | N9303827 |
| 2% HNO ₃ | 20 µg/mL: Co, Cr, Cu, Mn, Ni, V 10 µg/mL: As, Cd, Se, Zn 5 µg/mL: Ag | 125 mL | N9303829 |
| 5% HNO ₃ / tr Tartaric Acid/ tr HF | 500 µg/mL: Fe 250 µg/mL: Ba, Zn 100 µg/mL: Co, Cr, Cu, Mn, Ni, Sb, V 50 µg/mL: As, Pb 25 µg/mL: Ag, Be, Cd, Se, Tl | 125 mL | N9303839 |
| 5% HNO ₃ / tr Tartaric Acid/ tr HF | 250 µg/mL: Ba, Cr, Cu, Zn 150 µg/mL: V 125 µg/mL: Ni 100 µg/mL: Co, Pb, Sb 50 µg/mL: As, Cd 5 µg/mL: Ag, Be, Se, Tl | 125 mL | N9303840 |
| 5% HNO ₃ | 1,000 µg/mL: Al, Ca, Fe, K, Mg, Na 20 µg/mL: Ag, As, Ba, Be, Cd, Co, Cr, Cu, Mn, Ni, Pb, Se, Tl, V, Zn | 125 mL | N9303835 |
| H ₂ O/tr HF | 7,200 µg/mL: Cl 2,000 µg/mL: C 1,000 µg/mL: P, S 20 µg/mL: Mo, Sb, Ti | 125 mL | N9303836 |
| Calibration Standards Set for Method 6010 | | | N9307104 |
| 1 bottle each: | | | |
| 5% HNO ₃ | 5,000 µg/mL: Ca, K, Mg, Na | 125 mL | N9300218 |
| 5% HNO ₃ | 400 µg/mL: Ni 200 µg/mL: Zn 150 µg/mL: Mn 100 µg/mL: Ag, Cr | 125 mL | N9300219 |
| 5% HNO ₃ | 2,000 µg/mL: Al, Ba 1,000 µg/mL: Fe 500 µg/mL: Co, V 250 µg/mL: Cu 50 µg/mL: Be | 125 mL | N9300220 |
| 5% HNO ₃ | 100 µg/mL: As, Tl 50 µg/mL: Cd, Pb, Se | 125 mL | N9300221 |
| H ₂ O/tr HF | 10 µg/mL: B, Ge, Mo, Nb, P, Re, S, Si, Ta, Ti, W, Zr | 125 mL | N9300235 |
| 2% HNO ₃ | 1,000 µg/mL: Li | 500 mL | N9300129 |
| 2% HNO ₃ | 1,000 µg/mL: Sb | 500 mL | N9300101 |
| 2% HNO ₃ | 1,000 µg/mL: Sr | 500 mL | N9300153 |
| 20% HNO ₃ | 1,000 µg/mL: Sn | 500 mL | N9300161 |
| 2% HNO ₃ | 1,000 µg/mL: Cr | 500 mL | N9300112 |
| 2% HNO ₃ | 1,000 µg/mL: Cu | 500 mL | N9300114 |
| 2% HNO ₃ | 1,000 µg/mL: Mn | 500 mL | N9300132 |
| 2% HNO ₃ | 1,000 µg/mL: Ni | 500 mL | N9300136 |
| H ₂ O/tr HF | 1,000 µg/mL: Ti | 500 mL | N9300162 |
| 2% HNO ₃ | 1,000 µg/mL: V | 500 mL | N9300165 |
| 2% HNO ₃ | 1,000 µg/mL: Al | 500 mL | N9300100 |
| 2% HNO ₃ | 1,000 µg/mL: Ca | 500 mL | N9300108 |
| 2% HNO ₃ | 1,000 µg/mL: Fe | 500 mL | N9300126 |
| 2% HNO ₃ | 1,000 µg/mL: Mg | 500 mL | N9300131 |

Environmental Method Sets (con't)

| Matrix | Contents | Vol. | Part No. |
|--|---|--------|-----------------|
| Internal Standard Set for Method 6010 & 200.7 | | | N9307105 |
| 1 bottle each: | | | |
| 2% HNO ₃ | 1,000 µg/mL: Y | 500 mL | N9300167 |
| 2% HNO ₃ | 1,000 µg/mL: Sc | 500 mL | N9300148 |
| Interference Solutions for Method 6010 | | | N9307106 |
| 1 bottle each: | | | |
| 2% HNO ₃ | 1,000 µg/mL: Al | 125 mL | N9300184 |
| 2% HNO ₃ | 1,000 µg/mL: Ca | 500 mL | N9300108 |
| 2% HNO ₃ | 1,000 µg/mL: Mg | 125 mL | N9300179 |
| 2% HNO ₃ | 1,000 µg/mL: Fe | 500 mL | N9300126 |
| 2% HNO ₃ | 1,000 µg/mL: K | 500 mL | N9300141 |
| 2% HNO ₃ | 1,000 µg/mL: Na | 500 mL | N9300152 |
| 2% HNO ₃ | 1,000 µg/mL: Cr | 500 mL | N9300112 |
| 2% HNO ₃ | 1,000 µg/mL: Cu | 500 mL | N9300114 |
| 2% HNO ₃ | 1,000 µg/mL: Mn | 500 mL | N9300132 |
| 2% HNO ₃ | 1,000 µg/mL: Ni | 500 mL | N9300136 |
| H ₂ O/tr HF | 1,000 µg/mL: Ti | 500 mL | N9300162 |
| 2% HNO ₃ | 1,000 µg/mL: V | 500 mL | N9300165 |
| 5% HNO ₃ | 5,000 µg/mL: Al, Ca, Mg 2,000 µg/mL: Fe | 500 mL | N9300226 |
| 5% HNO ₃ / tr Tart-HF | 100 µg/mL: Cd, Ni, Zn 60 µg/mL: Sb 50 µg/mL: Ba, Be, Co, Cr, Cu, Mn, V 20 µg/mL: Ag 10 µg/mL: As, Tl 5 µg/mL: Pb, Se | 125 mL | N9300227 |
| 5% HNO ₃ | 1,000 µg/mL: Cr, Cu, Mn, Ni, Ti, V | 500 mL | N9300228 |
| 5% HNO ₃ / tr Tartaric Acid/ tr HF | 100 µg/mL: Al, As, B, Mo, Na, Sb, Se, Tl 10 µg/mL: Ca, Fe, Mg, Si | 125 mL | N9300229 |
| Calibration Standards for Method 200.7 | | | N9307107 |
| 5% HNO ₃ | 5,000 µg/mL: Ca, K, Mg, Na | 125 mL | N9300218 |
| 5% HNO ₃ | 400 µg/mL: Ni 200 µg/mL: Zn 150 µg/mL: Mn 100 µg/mL: Ag, Cr | 125 mL | N9300219 |
| 5% HNO ₃ | 2,000 µg/mL: Al, Ba 1,000 µg/mL: Fe 500 µg/mL: Co, V 250 µg/mL: Cu 50 µg/mL: Be | 125 mL | N9300220 |
| 5% HNO ₃ | 100 µg/mL: As, Tl 50 µg/mL: Cd, Pb, Se | 125 mL | N9300221 |
| H ₂ O/tr HF | 10 µg/mL: B, Ge, Mo, Nb, P, Re, S, Si, Ta, Ti, W, Zr | 125 mL | N9300235 |
| 2% HNO ₃ | 1,000 µg/mL: Li | 500 mL | N9300129 |
| 2% HNO ₃ | 1,000 µg/mL: Sb | 500 mL | N9300101 |
| 2% HNO ₃ | 1,000 µg/mL: Sr | 500 mL | N9300153 |
| 20% HNO ₃ | 1,000 µg/mL: Sn | 500 mL | N9300161 |

Environmental Method Sets (con't)

| Matrix | Contents | Vol. | Part No. |
|---|--|--------|-----------------|
| Interference Solutions for Method 200.7 | | | N9307108 |
| 2% HNO ₃ | 1,000 µg/mL: Al | 125 mL | N9300184 |
| 2% HNO ₃ | 1,000 µg/mL: Ca | 500 mL | N9300108 |
| 2% HNO ₃ | 1,000 µg/mL: Mg | 125 mL | N9300179 |
| 2% HNO ₃ | 1,000 µg/mL: Fe | 500 mL | N9300126 |
| 2% HNO ₃ | 1,000 µg/mL: K | 500 mL | N9300141 |
| 2% HNO ₃ | 1,000 µg/mL: Na | 500 mL | N9300152 |
| 5% HNO ₃ | 5,000 µg/mL: Al, Ca, Mg 2,000 µg/mL: Fe | 500 mL | N9300226 |
| 5% HNO ₃ / tr Tart-HF | 100 µg/mL: Cd, Ni, Zn 60 µg/mL: Sb 50 µg/mL: Ba, Be, Co, Cr, Cu, Mn, V 20 µg/mL: Ag 10 µg/mL: As, Tl 5 µg/mL: Pb, Se | 125 mL | N9300227 |
| Environmental EPA Set 1 | | | N9307110 |
| 2% HNO ₃ | 500 µg/mL: Pb 200 µg/mL: Se 150 µg/mL: Cd, Zn 100 µg/mL: Mn 50 µg/mL: Be | 125 mL | N9300200 |
| 5% HNO ₃ | 10,000 µg/mL: Fe 100 µg/mL: Ba, Co, Cu, V | 125 mL | N9300201 |
| 2% HNO ₃ / tr HF | 500 µg/mL: As 100 µg/mL: Mo, Si | 125 mL | N9300202 |
| 5% HNO ₃ | 1,000 µg/mL: Ca 400 µg/mL: K 200 µg/mL: Al, Na 20 µg/mL: Cr, Ni | 125 mL | N9300203 |
| 5% HNO ₃ / tr Tart-HF | 1,000 µg/mL: Mg 200 µg/mL: Sb, Tl 100 µg/mL: B 50 µg/mL: Ag | 125 mL | N9300204 |
| 5% HNO ₃ | 20,000 µg/mL: K 1,000 µg/mL: As, Pb, Tl 500 µg/mL: Se 300 µg/mL: Ag, Ba, Cd, Co, Cr, Cu, Ni, V, Zn 200 µg/mL: Mn 100 µg/mL: Be | 125 mL | N9300205 |
| 5% HNO ₃ | 100 µg/mL: Hg | 125 mL | N9300223 |
| 5% HNO ₃ | 6,000 µg/mL: Ca 5,000 µg/mL: Fe 3,000 µg/mL: Mgs 1,200 µg/mL: Al 1,000 µg/mL: Na | 125 mL | N9300208 |
| H ₂ O/tr HNO ₃ / 0.6% Tartaric Acid | 1,000 µg/mL: Sb | 125 mL | N9300207 |
| 5% HNO ₃ | ASTM® Type I Water | 500 mL | N9307809 |
| 5% HCl | ASTM® Type I Water | 500 mL | N9307810 |
| Environmental EPA Set 2 | | | N9307109 |
| 2% HNO ₃ | 500 µg/mL: Pb 200 µg/mL: Se 150 µg/mL: Cd, Zn 100 µg/mL: Mn 50 µg/mL: Be | 125 mL | N9300200 |
| 5% HNO ₃ | 10,000 µg/mL: Fe 100 µg/mL: Ba, Co, Cu, V | 125 mL | N9300201 |
| 2% HNO ₃ / tr HF | 500 µg/mL: As 100 mg/mL: Mo, Si | 125 mL | N9300202 |

| Matrix | Contents | Vol. | Part No. |
|---|--|--------|-----------------|
| 5% HNO ₃ | 1,000 µg/mL: Ca 400 µg/mL: K 200 µg/mL: Al, Na 20 µg/mL: Cr, Ni | 125 mL | N9300203 |
| 5% HNO ₃ / tr Tart-HF | 1,000 µg/mL: Mg 200 µg/mL: Sb, Tl 100 µg/mL: B 50 µg/mL: Ag | 125 mL | N9300204 |
| 5% HNO ₃ | 20,000 µg/mL: K 1,000 µg/mL: As, Pb, Tl 500 µg/mL: Se 300 µg/mL: Ag, Ba, Cd, Co, Cr, Cu, Ni, V, Zn 200 µg/mL: Mn 100 µg/mL: Be | 125 mL | N9300205 |
| 5% HNO ₃ | 6,000 µg/mL: Ca 5,000 µg/mL: Fe 3,000 µg/mL: Mgs 1,200 µg/mL: Al 1,000 µg/mL: Na | 125 mL | N9300208 |
| H ₂ O/tr HNO ₃ / 0.6% Tartaric Acid | 1,000 µg/mL: Sb | 125 mL | N9300207 |
| 5% HNO ₃ | ASTM® Type I Water | 500 mL | N9307809 |
| 5% HCL | ASTM® Type I Water | 500 mL | N9307810 |

Water Pollutant Standards

| Matrix | Contents | Vol. | Part No. |
|--|---|--------|-----------------|
| Primary Drinking Water Metals | | | |
| 2% HNO ₃ | 100 µg/mL: Ba 10 µg/mL: Ag, As, Cr, Hg*, Pb 5 µg/mL: Cd, Se | 125 mL | N9300216 |
| Secondary Drinking Water Metals | | | |
| 2% HNO ₃ | 500 µg/mL: Zn 100 µg/mL: Cu 30 µg/mL: Fe 5 µg/mL: Mn | 125 mL | N9300217 |
| Trace Metals I | | | |
| 5% HNO ₃ | 500 µg/mL: Al 250 µg/mL: V 100 µg/mL: As, Be, Co, Cr, Cu, Fe Mn, Ni, Pb, Zn 25 µg/mL: Cd, Se 10 µg/mL: Hg* | 125 mL | N9300211 |
| *Supplied in separate bottle. | | | |
| Trace Metals II | | | |
| 2% HNO ₃ | 20 µg/mL: Sb, Tl 10 µg/mL: Ag | 125 mL | N9300212 |
| Trace Metals III | | | |
| 2% HNO ₃ | 500 µg/mL: Ba, Ca, Mo, Na 100 µg/mL: K, Mg | 125 mL | N9300213 |
| Alternate Metals I | | | |
| 2% HNO ₃ | 20 µg/mL: Al, Fe, V 10 µg/mL: Co, Cu, Mn, Ni, Zn 5 µg/mL: Be, Sb, Tl | 125 mL | N9300214 |
| Alternate Metals II | | | |
| 2% HNO ₃ | 500 µg/mL: Ca, Na 100 µg/mL: K, Mg | 125 mL | N9300215 |
| Alternate Metals II | | | |
| 2% HNO ₃ | 500 µg/mL: Ca, Na 100 µg/mL: K, Mg | 500 mL | N9303952 |

Toxicity Characteristic Leachate Procedure (TCLP) Standard

| Matrix | Contents | Vol. | Part No. |
|------------------------|--|--------|-----------------|
| TCLP Standard 1 | | | |
| 2% HNO ₃ | 500 µg/mL: Ba 25 µg/mL: Ag, As, Cr, Pb 100 µg/mL: Hg* 5 µg/mL: Cd, Se <small>*Supplied in separate bottle.</small> | 500 mL | N9300241 |

PHARMACEUTICAL ANALYSIS STANDARDS



USP Standards

As a part of our United States Pharmacopeia (USP) compliant offering, we provide calibration and check standards for the analysis of metals in drugs, pharmaceutical substances and raw materials to verify Oral Daily Dose PDE, Parenteral Component Limit and Parenteral Daily Dose PDE.

Our trace metal USP standards can be used to calibrate Arsenic, Cadmium, Lead and Mercury, the four toxic metals as part of the USP regulations. When you couple our accurate and reliable USP standards with your ICP-MS you will remain compliant with the new and changing regulations.

ICH Standards

In conjunction with our United States Pharmacopeia (USP) calibration standards, we offer six calibration standards for the analysis of metals in pharmaceutical materials and products following the International Conference on Harmonization (ICH) guidelines.

The ICH standards verify Elemental Impurities, Precious Metals Impurities and Parenteral Elemental Impurities. Couple our accurate and reliable ICH standards with your ICP-MS and you will remain compliant with the new and changing regulations.

USP AND ICH STANDARDS

| Description | Matrix | Contents | Vol. | Part No. |
|---|---------------------|---|--------|-----------------|
| USP Oral Elemental Impurities A (Big 4) | 5% HNO ₃ | 25 mg/kg: Cd 15 mg/kg Hg 5 mg/kg Pb 1.5 mg/kg As | 125 mL | N9304150 |
| USP Precious Metal Impurities B (with Os) | 15% HCl | 100 mg/kg: Ir, Pd, Pt, Rh, Ru, Os | 125 mL | N9304151 |
| USP Precious Metals Impurities B | 15% HCl | 100 mg/kg: Ir, Pd, Pt, Rh, Ru | 125 mL | N9304152 |
| USP Oral /Parenteral Elemental Impurities C | 5% HNO ₃ | 1000 mg/kg: Cu 500 mg/kg Ni 100 mg/kg Mo, V | 125 mL | N9304153 |
| USP Parenteral Elemental Impurities D (Big 4) | 5% HNO ₃ | 5 mg/kg: Pb 2.5 mg/kg Cd 1.5 mg/kg As, Hg | 125 mL | N9304154 |
| USP Dietary Supplement Metal Impurities | 5% HNO ₃ | 15 mg/kg: As 5 mg/kg Pb 2.5 mg/kg Cd 1.5 mg/kg Hg | 125 mL | N8145322 |
| USP Inhalation Metal Impurities A | 5% HNO ₃ | 1.5 mg/kg: As, Cd, Hg, 5 mg/kg Pb, | 125 mL | N8145323 |
| USP Inhalation Metal Impurities B | 5% HNO ₃ | 250 mg/kg: Mo 70 mg/kg Cu 30 mg/kg V 25 mg/kg Cr, 1.5 mg/kg Ni | 125 mL | N8145324 |
| ICH Oral Elemental Impurities A (Big 4) | 5% HNO ₃ | 25 mg/kg: Cd 15 mg/kg Hg 5 mg/kg Pb 1.5 mg/kg As | 125 mL | N9304155 |
| ICH Precious Metal Impurities B (with Os) | 15% HCl | 100 mg/kg: Ir, Pd, Pt, Rh, Ru, Os | 125 mL | N9304156 |
| ICH Precious Metals Impurities B | 15% HCl | 100 mg/kg: Ir, Pd, Pt, Rh, Ru | 125 mL | N9304157 |
| ICH Parenteral Elemental Impurities D (Big 4) | 5% HNO ₃ | 5 mg/kg: Pb 2.5 mg/kg Cd 1.5 mg/kg As, Hg | 125 mL | N9304158 |
| Global/ICH Elemental Impurities E | 5% HNO ₃ | 2500 mg/kg: Mn 1000 mg/kg Cu 250 mg/kg Cr, Ni 100 mg/kg Co, Mo, V | 125 mL | N9304159 |
| Global/ICH Elemental Impurities F | 5% HNO ₃ | 13,000 mg/kg: Fe, Zn | 125 mL | N9304160 |



GOLD NANOPARTICLE STANDARDS

| Description | Diam (nm) | Number of Particles/mL | Vol. (mL) | Part No. |
|--|-----------|------------------------|-----------|-----------------|
| 30 nm Spherical Au Nanoparticle in DI Water | 30 | 2.00E+11 | 25 | N8142300 |
| 40 nm Spherical Au Nanoparticle in DI Water | 40 | 8.70E+10 | 25 | N8142301 |
| 50 nm Spherical Au Nanoparticle in DI Water | 50 | 4.50E+10 | 25 | N8142302 |
| 60 nm Spherical Au Nanoparticle in DI Water | 60 | 2.60E+10 | 25 | N8142303 |
| 70 nm Spherical Au Nanoparticle in DI Water | 70 | 1.60E+10 | 25 | N8142304 |
| 80 nm Spherical Au Nanoparticle in DI Water | 80 | 1.10E+10 | 25 | N8142305 |
| 90 nm Spherical Au Nanoparticle in DI Water | 90 | 7.80E+09 | 25 | N8142306 |
| 100 nm Spherical Au Nanoparticle in DI Water | 100 | 5.70E+09 | 25 | N8142307 |

INSTRUMENT SET-UP AND CALIBRATION STANDARDS



From instrument installation to instrument calibration, we provide quality set-up, check and calibration standards to ensure instrument performance.

Instrument Calibration Standards

| Matrix | Contents | Vol. | Part No. |
|---|--|----------|-----------------|
| Instrument Calibration Standard 1 | | | |
| 5% HNO ₃ / tr Tartaric Acid | 20 µg/mL: Ag, Al, As, Ba, Be, Cd, Co, Cr, Cu, Mn, Mo, Ni, Pb, Sb, Se, Th, Tl, U, V, Zn | 125 mL | N9303816 |
| Instrument Calibration Standard 2 | | | |
| 5% HNO ₃ / tr Tartaric Acid/ tr HF | 100 µg/mL: Ag, Al, As, Ba, Be, Ca, Cd, Co, Cr, Cu, Fe, K, Mg, Mn, Mo, Na, Ni, Pb, Sb, Se, Sn, Sr, Ti, Tl, V, Zn | 125 mL | N9301721 |
| Instrument Calibration Standard 3 | | | |
| 5% HNO ₃ | 1,000 µg/mL: Ca, Fe, K, Mg, Na | 125 mL | N9303818 |
| Initial Calibration Verification Standard 1 | | | |
| 5% HNO ₃ / tr Tartaric Acid | 1,000 µg/mL: Ca, Fe, K, Mg, Na, Sr 10 µg/mL: Ag, Al, As, Ba, Be, Cd, Co, Cr, Cu, Mn, Mo, Ni, Pb, Sb, Se, Tl, V, Zn, Th, U | 125 mL | N9303825 |
| Initial Calibration Verification Standard 2 | | | |
| 2% HNO ₃ / tr HF | 10 µg/mL: Sn, Ti | 125 mL | N9303826 |
| ELAN® 6100 DRC Setup/Stab/Masscal Solution | | | |
| 0.5% HNO ₃ | 10 µg/L: Ba 1 µg/L: Al, Cd, Ce, Cr, Cu, In, Pb, Mg, Mn, Rh, Th | 1,000 mL | N8125035 |
| ELAN DRC/DRCplus/DRC II Solution Kit | | | |
| Solution Kit (Includes items listed below) | | | N8120541 |
| 2 x 1,000 mL: Setup/Stability/Masscal Solution | | | N8125035 |
| 2 x 250 mL: Wash Solution | | | N8125033 |
| 1 x 250 mL: Sensitivity/Detection Limit Solution | | | N8125034 |
| 1 x 125 mL: Methanol Blank Solution | | | N8125037 |
| 1 x 125 mL: Chromium in Methanol Solution | | | N8125038 |

Instrument Calibration Standards (con't)

| Matrix | Contents | Part No. |
|--|--|--------------------------|
| ELAN 9000/6100 Solution Kit | | |
| 2 x 1,000 mL: Setup/Stability/Masscal Solution | | N8125030 |
| 1 x 125 mL: Dual-Detector | | N8125010 |
| 1 x 1,000 mL: Wash Solution | | N8122038 |
| 1 x 250 mL: Detection Limit Solution | | N8125031 |
| ELAN 9000/6100 Setup/Stability/Masscal Solution | | |
| 1% HNO ₃ | 10 µg/L: Ba, Cd, Ce, Cu, In, Pb, Mg, Rh, U | 1,000 mL N8125030 |
| ELAN 9000/6x00 Dual-Detector Calibration Solution | | |
| 1% HNO ₃ | 200 µg/L: Cd, Cu, Pb, Mg, Rh | 125 mL N8125032 |
| ELAN 6000/5000 Plasma Setup Solution | | |
| 2% HNO ₃ | 10 µg/L: Ba, Cd, Ce, Cu, Ge, Rh, Sc, Pb, Mg, Rh, Sc, Tb, Tl | 1,000 mL N8122014 |
| ELAN 5000 Detection Limit Solution | | |
| 2% HNO ₃ | 10 µg/L: Be, Co, Ge, In, Tl, U | 125 mL N8122017 |

SmartTune Standards

| Matrix | Contents | Vol. | Part No. |
|--|---|----------|-----------------|
| SmartTune Solution for Standard ELANs/DRC-e | | | |
| 1% HNO ₃ | 10 µg/L: Ba, Be, Ce, Co, In, Pb, Mg, Rh, U | 1,000 mL | N8125040 |
| SmartTune Solution for DRC/DRCplus/DRC II | | | |
| 0.5% HNO ₃ | 10 µg/L: Ba 1 µg/L: Be, Ce, Co, In, Fe, Pb, Mg, Th, U | 1,000 mL | N8125041 |
| Tuning Solution 1 | | | |
| 2% HNO ₃ / 5% HCL | 10 µg/mL: Ba, Be, Ce, Co, In, Li, Mg, Pb, Rh, Tl, U, Y | 125 mL | N9303843 |
| NexION Setup Solution | | | |
| 1% HNO ₃ | 1 µg/L: Be, Ce, Fe, In, Li, Mg, Pb, U | 500 mL | N8145051 |
| 1% HNO ₃ | 10 µg/L: Be, Ce, Fe, In, Li, Mg, Pb, U | 500 mL | N8145284 |

Instrument Setup Solutions

| Matrix | Contents | Vol. | Part No. |
|-------------------------------------|--|--------|-----------------|
| Vis Wavecal Solution | | | |
| 2% HNO ₃ | 50 µg/mL: K 10 µg/mL: La, Li, Mn, Na, Sr 1 µg/mL: Ba, Ca | 250 mL | N9302946 |
| UV Wavecal Solution | | | |
| 5% HCL | 100 µg/mL: K, P, S 20 µg/mL: As, La, Li, Mn, Mo, Na, Mo, Na, Ni, Sc | 250 mL | N0681470 |
| 5% HCL | 100 µg/mL: K, P, S 20 µg/mL: As, La, Li, Mn, Mo, Na, Ni, Sc 1 µg/mL: Ca | 500 mL | N0582152 |
| Low UV Standard | | | |
| 2% HNO ₃ | 10 µg/mL: Al, P, S | 250 mL | N0691580 |
| Calcium Stray Light Standard | | | |
| H ₂ O | 10,000 µg/mL: Ca | 125 mL | N0691581 |
| 1% HNO ₃ | 10 µg/L: Be, Ce, Fe, In, Li, Mg, Pb, U | 500 mL | N8145284 |

Initial Calibration Verification Standards

| Matrix | Contents | Vol. | Part No. |
|---|---|--------|-----------------|
| 5% HNO ₃ / tr Tartaric Acid | 500 µg/mL: Ca, K, Mg, Na 200 µg/mL: Al, Ba 100 µg/mL: Fe 60 µg/mL: Sb 50 µg/mL: Co, V 40 µg/mL: Ni 25 µg/mL: Cu 20 µg/mL: Zn 15 µg/mL: Mn 10 µg/mL: Ag, As, Cr, Tl 5 µg/mL: Be, Cd, Se 3 µg/mL: Pb | 500 mL | N9300224 |
| 5% HNO ₃ / tr Tartaric Acid | 500 µg/mL: Ca, K, Mg, Na 200 µg/mL: Al, Ba 100 µg/mL: Fe 60 µg/mL: Sb 50 µg/mL: Co, V 40 µg/mL: Ni 25 µg/mL: Cu 20 µg/mL: Zn 15 µg/mL: Mn 10 µg/mL: Ag, As, Cr, Tl 5 µg/mL: Be, Cd, Se 3 µg/mL: Pb | 125 mL | N9303953 |

Instrument Calibration Standards for CLP

| Matrix | Contents | Vol. | Part No. |
|--|---|--------|-----------------|
| Instrument Calibration Standard 1 | | | |
| 5% HNO ₃ | 5,000 µg/mL: Ca, K, Mg, Na | 125 mL | N9300218 |
| Instrument Calibration Standard 2 | | | |
| 5% HNO ₃ | 400 µg/mL: Ni 200 µg/mL: Zn 150 µg/mL: Mn 100 µg/mL: Ag, Cr | 125 mL | N9300219 |
| Instrument Calibration Standard 3 | | | |
| 5% HNO ₃ | 2,000 µg/mL: Al, Ba 1,000 µg/mL: Fe 500 µg/mL: Co, V 250 µg/mL: Cu 50 µg/mL: Be | 125 mL | N9300220 |
| Instrument Calibration Standard 4 | | | |
| 5% HNO ₃ | 100 µg/mL: As, Tl 50 µg/mL: Cd, Se 30 µg/mL: Pb | 125 mL | N9300221 |

Instrument Check Standards

| Matrix | Contents | Vol. | Part No. |
|---|---|--------|-----------------|
| Instrument Check Standard 1 | | | |
| 2% HNO ₃ / tr Tartaric Acid/ tr HF | 10 µg/L: Ba 1 µg/L: Be, Ce, Co, In, Fe, Pb, Mg, Co, Cr, Cu, Mn, Ni, Pb, Sb, Se, Tl, V, Zn | 125 mL | N9303821 |
| Instrument Check Standard 3 | | | |
| 2% HNO ₃ | 200 µg/mL: Ca, Fe, K, Mg, Na | 125 mL | N9303822 |
| Instrument Check Standard 4 | | | |
| 2% HNO ₃ | 10 µg/mL: Mo, Th, U | 125 mL | N9303823 |
| Instrument Check Standard 5 | | | |
| 2% HNO ₃ / tr HF | 10 µg/mL: Mo, Sn, Sr, Ti | 125 mL | N9303824 |

Interference Check Standards

| Matrix | Contents | Vol. | Part No. |
|--|---|--------|-----------------|
| Interference Check Standard 1 | | | |
| H ₂ O/tr HNO ₃ / 0.6% Tartaric Acid | 1,000 µg/mL: Sb | 125 mL | N9300207 |
| Interference Check Standard 5 | | | |
| 5% HNO ₃ | 6,000 µg/mL: Ca 5,000 µg/mL: Fe 3,000 µg/mL: Mg 1,200 µg/mL: Al 1,000 µg/mL: Na | 125 mL | N9300208 |
| Interference Check Standard 18 | | | |
| 5% HNO ₃ | 20,000 µg/mL: K 1,000 µg/mL: As, Pb, Tl 500 µg/mL: Se 300 µg/mL: Ag, Ba, Cd, Co, Cr, Cu, Ni, V, Zn 200 µg/mL: Mn 100 µg/mL: Be, Hg* | 125 mL | N9300205 |
| Interferents A | | | |
| 5% HNO ₃ | 5,000 µg/mL: Al, Ca, Mg 2,000 µg/mL: Fe | 500 mL | N9300226 |
| Alternate Interferents A | | | |
| 5% HNO ₃ | 1,000 µg/mL: Cr, Cu, Mn, Ni, Ti, V | 500 mL | N9300228 |
| Analytes B | | | |
| 5% HNO ₃ / tr Tartaric Acid/ tr HF | 100 µg/mL: Cd, Ni, Zn 60 µg/mL: Sb 50 µg/mL: Ba, Be, Co, Cr, Cu, Mn, V 20 µg/mL: Ag 10 µg/mL: As, Tl 5 µg/mL: Pb, Se | 125 mL | N9300227 |
| Alternate Analytes B | | | |
| 5% HNO ₃ / tr Tartaric Acid/ tr HF | 100 µg/mL: Al, As, B, Mo, Na, Sb, Se, Tl 10 µg/mL: Ca, Fe, Mg, Si | 125 mL | N9300229 |
| Interference Check Standards | | | |
| H ₂ O/tr HNO ₃ / 0.6% Tartaric Acid | 1,000 µg/mL: Sb | 500 mL | N9303797 |
| Interference Check Solution 1 (for SW-846 & ILM 05.2) | | | |
| 5% HNO ₃ / tr HF | 10,000 µg/mL: Cl 2,000 µg/mL: C 1,000 µg/mL: Al, Ca, Fe, K, Mg, Na, P, S 20 µg/mL: Mo, Ti | 125 mL | N9303828 |
| Interference Check Solution 2 (for SW-846) | | | |
| 2% HNO ₃ | 10 µg/mL: Ag, As, Cd, Co, Cr, Cu, Mn, Ni, Zn | 125 mL | N9303830 |
| Analytes C (for ILM 05.2) | | | |
| 2% HNO ₃ / tr Tartaric Acid/ tr HF | 2 µg/mL: Ag, As, Ba, Be, Cd, Co, Cr, Cu, Hg*, Mn, Ni, Pb, Sb, Se, Tl, V, Zn | 125 mL | N9303831 |

*Supplied in separate bottle.

Internal Standard Solutions

| Matrix | Contents | Vol. | Part No. |
|--|--------------------------------------|--------|-----------------|
| Multi-Element Internal Standard | | | |
| 2% HNO ₃ | 10 µg/mL: Bi, Ho, In, Li6, Sc, Tb, Y | 125 mL | N9303834 |
| Internal Standard Mix | | | |
| 5-10% HNO ₃ | 10 µg/mL: Bi, Ge, In, Li6, Sc, Tb, Y | 125 mL | N9303832 |
| Internal Standard Mix | | | |
| 5-10% HNO ₃ | 10 µg/mL: Bi, Ge, In, Li6, Sc, Tb, Y | 125 mL | N9303833 |

Contract Required Detection Limits (CRDL)

| Matrix | Contents | Vol. | Part No. |
|---|--|--------|-----------------|
| 5% HNO ₃ / tr Tartaric Acid/ tr HF | 120 µg/mL: Sb 100 µg/mL: Co, V 80 µg/mL: Ni 50 µg/mL: Cu 40 µg/mL: Zn 30 µg/mL: Mn 20 µg/mL: Ag, As, Cr, Tl 10 µg/mL: Be, Cd, Se 6 µg/mL: Pb | 125 mL | N9300225 |

Performance Verification Standards

| Matrix | Contents | Vol. | Part No. |
|---|---|--------|-----------------|
| Methanol Blank Solution | | | |
| 1% Semiconductor Grade | 10 µg/mL: Cr | 125 mL | N8125037 |
| Chromium in Methanol Solution | | | |
| 1% Semiconductor Grade Methanol | 10 µg/mL: Cr | 125 mL | N8125038 |
| Selenium Solution | | | |
| 5% HNO ₃ | 10 µg/mL: Se | 250 mL | N8125039 |
| NexION® 300Q Solution Kit – Non-Cell | | | |
| Solution Kit (Includes items listed below) | | | N8140503 |
| 1% HNO ₃ | 1 x 250 mL NexION Wash Solution | | N8145050 |
| | 1 X 500 mL NexION Setup Solution | | N8145051 |
| | 1 X 500 mL NexION 300Q Non-cell Stability Solution | | N8145053 |
| | 1 x 100 mL NexION Standard/ DRC Mode Detection Limit Blank Solution | | N8145055 |
| | 1 X 100 mL NexION Standard/ DRC Mode Detection Limit Solution | | N8145056 |
| | 1 x 100 mL NexION Dual Detector Solution | | N8145059 |
| NexION 300 X/D/S Solution Kit – Cell Instruments | | | |
| Solution Kit (Includes items listed below) | | | N8140504 |
| 1% HNO ₃ | 1 x 250 mL NexION Wash Solution | | N8145050 |
| | 1 X 500 mL NexION Setup Solution | | N8145051 |
| | 1 x 250 mL NexION KED Setup Solution | | N8145052 |
| | 1 x 500 mL NexION 300X/D/S Cell Stability Solution | | N8145054 |
| | 1 x 100 mL NexION Standard/DRC Mode Detection Limit Blank Solution | | N8145055 |
| | 1 x 100 mL NexION Standard/DRC Mode Detection Limit Solution | | N8145056 |

Instrument Calibration Standards (con't)

| Matrix | Contents | Vol. | Part No. |
|--|---|--------|-----------------|
| | 1 x 100 mL NexION KED Mode Detection Limit Blank Solution | | N8145057 |
| | 1 x 100 mL NexION KED Mode Detection Limit Solution | | N8145058 |
| | 1 x 100 mL NexION Dual Detector Solution | | N8145059 |
| NexION Setup Solution | | | |
| 1% HNO ₃ | 1 µg/L: Be, Ce, Fe, In, Li, Mg, Pb, U | 500 mL | N8145051 |
| 1% HNO ₃ | 10 µg/L: Be, Ce, Fe, In, Li, Mg, Pb, U | 500 mL | N8145284 |
| NexION KED Setup Solution | | | |
| 1% HNO ₃ | 10 µg/mL: Be, Ce, Fe, In, Li, Mg, Pb, U | 500 mL | N8145289 |
| 1% HCL | 10 µg/L: Co 1 µg/L: Ce | 250 mL | N8145052 |
| NexION 300Q Non-cell Stability Solution | | | |
| 1% HNO ₃ | 1 µg/L: Cd, Cu, Mg, Pb | 500 mL | N8145053 |
| NexION 300X/D/S Cell Stability Solution | | | |
| 1% HNO ₃ | 1 µg/L: Cd, Cr, Fe, In, Mg, Pb 10 µg/L: Co, Cu, Se | 500 mL | N8145054 |
| NexION 300X/D Internal Standard Stock Solution | | | |
| 2% HNO ₃ | 100 µg/mL: Sc 50 µg/mL: Ge 1 µg/mL: Rh, In, Tb | 125 mL | N9308592 |
| NexION 300Q Internal Standard Stock Solution | | | |
| 2% HNO ₃ | 50 µg/mL: Sc, Ge 10 µg/mL: Rh, In, Tb | 125 mL | N9308591 |
| NexION Standard/DRC Mode Detection Limit Blank Solution | | | |
| 0.5% HNO ₃ | | 100 mL | N8145055 |
| NexION Standard/DRC Mode Detection Limit Solution | | | |
| 0.5% HNO ₃ | 1 µg/L: Be, Ca, Co, Fe, In, U | 100 mL | N8145056 |
| NexION KED Mode Detection Limit Blank Solution | | | |
| 1% HCL | | 100 mL | N8145057 |
| NexION KED Mode Detection Limit Solution | | | |
| 1% HCL | 10 µg/L: V, As, Se | 100 mL | N8145058 |
| NexION Dual Detector Solution | | | |
| 2% HNO ₃ | 200 µg/L: Al, Ba, Ce, Co, Cu, In, Li, Mg, Mn, Ni, Pb, Tb, U, Zn | 100 mL | N8145059 |
| NexION AFT Single-Element Solution | | | |
| 2% HNO ₃ | 2 µg/L: Fe | 100 mL | N8145060 |
| NexION AFT Multi-Element Solution | | | |
| 2% HNO ₃ | 2 µg/L: Ag, Al, As, Ba, Be, Bi, Ce, Bi, Ca, Cd, Co, Cr, Cs, Cu, Fe, Ga, In, K, Li, Mg, Mn, Na, Ni, Pb, Rb, Se, Sr, Tl, U, V, Zn | 100 mL | N8145061 |



Universal Data Acquisition Standards Kit

Our Universal Data Acquisition Standards Kit includes 5 standards solutions in bottles of 125 mL.

Universal Data Acquisition Standards Kit

| Matrix | Contents | Vol. | Part No. |
|--|--|--------|-----------------|
| Solution Kit (Includes items listed below) | | | |
| Solution Kit (Includes items listed below) | | | N9306225 |
| 5% HNO ₃ | 10 µg/mL: Ce, Dy, Er, Eu, Gd, Ho, La, Lu, Nd, Pr, Sm, Sc, Tb, Th, Tm, Y, Yb | 125 mL | N9300232 |
| 5% HNO ₃ | 10 µg/mL: Al, Ag, As, Ba, Be, Bi, Ca, Cd, Co, Cr, Cs, Cu, Fe, Ga, Hg*, In, K, Li, Mg, Mn, Na, Ni, Pb, Rb, Se, Sr, Tl, U, V, Zn | 125 mL | N9300233 |
| 10% HCL/ 1% HNO ₃ | 10 µg/mL: Au, Hf, Ir, Pd, Pt, Rh, Ru, Sb, Sn, Te | 125 mL | N9300234 |
| 5% HNO ₃ | 10 µg/mL: Hg | 125 mL | N9300253 |
| H ₂ O/tr HF /tr HNO ₃ | 10 µg/mL: B, Ge, Mo, Nb, P, Re, S, Si, Ta, Ti, W, Zr | 125 mL | N9300235 |

*Supplied in separate bottle.

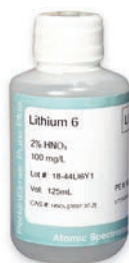

Isotope Standard

The PerkinElmer ICP and ICP-MS isotope standard comes in a 125 mL bottle and is supplied with a comprehensive Certificate of Analysis.

Isotope Standard

| Matrix | Contents | Vol. | Part No. |
|---------------------------|----------------|--------|-----------------|
| Lithium 6 Standard | | | |
| 2% HNO ₃ | 100 µg/mL: Li6 | 125 mL | N9303955 |



Matrix Blanks and Wash Standards

We offer wash standards and matrix blanks for your application needs.

Wash Standards

| Matrix | Vol. | Part No. |
|---|----------|-----------------|
| ELAN DRC Wash Solution | | |
| 0.5% HNO ₃ | 250 mL | N8125033 |
| ELAN 9000/6X00/DRC-e Wash Solution | | |
| 1% HNO ₃ | 1,000 mL | N8122038 |
| NexION Wash Solution | | |
| 1% HNO ₃ | 250 mL | N8145050 |

Matrix Blanks

| Matrix | Vol. | Part No. |
|---|--------|-----------------|
| Water Blank | | |
| ASTM® Type I Water, 18 megohm | 125 mL | N9303814 |
| ASTM® Type I Water, 18 megohm | 250 mL | N9303813 |
| Hydrochloric Acid Blanks | | |
| 2% HCl in ASTM® Type I Water | 125 mL | N9300238 |
| 5% HNO ₃ in ASTM® Type I Water | 500 mL | N9308571 |
| Nitric Acid Blanks | | |
| 1% HNO ₃ in ASTM® Type I Water | 125 mL | N9303732 |
| 2% HNO ₃ in ASTM® Type I Water | 125 mL | N0773120 |
| 5% HNO ₃ in ASTM® Type I Water | 500 mL | N9308571 |

METALLO-ORGANIC STANDARDS



PerkinElmer Metallo-Organic Standards provide a comprehensive solution to your application needs.

Our product offering includes:

- Single and multi-element standards for the analysis of wear metals and metal additives in oil
- Reference materials for used oil analysis of fuel, soot, water, acid number, base number, or viscosity
- Sulfur standards made from polysulfide oil
- High purity matrix oils and solvents
- Proficiency testing standards with instant feedback

Each product is shipped with a comprehensive Certificate of Analysis.

Our Metallo-Organic Standards have been designed to give you the confidence you need when analyzing difficult samples.

Lubricants Guide



For more information on our Lubricants consumables offering visit www.PerkinElmer.com/lubricants. You'll find everything from application notes to a comprehensive guide of consumables for all your Lubricants analysis needs.

Single-Element, Metallo-Organic Standards

| Element Name | Symbol | Matrix | Size | Part No. |
|----------------------|--------|-----------------|------|----------|
| Aluminum 1000 µg/g | Al | hydrocarbon oil | 50 g | N9308200 |
| Antimony 1000 µg/g | Sb | hydrocarbon oil | 50 g | N9308201 |
| Arsenic 1000 µg/g | As | hydrocarbon oil | 50 g | N9308202 |
| Barium 1000 µg/g | Ba | hydrocarbon oil | 50 g | N9308203 |
| Beryllium 1000 µg/g | Be | hydrocarbon oil | 50 g | N9308204 |
| Bismuth 1000 µg/g | Bi | hydrocarbon oil | 50 g | N9308205 |
| Boron 1000 µg/g | B | hydrocarbon oil | 50 g | N9308206 |
| Cadmium 1000 µg/g | Cd | hydrocarbon oil | 50 g | N9308207 |
| Calcium 1000 µg/g | Ca | hydrocarbon oil | 50 g | N9308208 |
| Calcium 5000 µg/g | Ca | hydrocarbon oil | 50 g | N9308322 |
| Chromium 1000 µg/g | Cr | hydrocarbon oil | 50 g | N9308209 |
| Cobalt 1000 µg/g | Co | hydrocarbon oil | 50 g | N9308210 |
| Copper 1000 µg/g | Cu | hydrocarbon oil | 50 g | N9308211 |
| Iron 1000 µg/g | Fe | hydrocarbon oil | 50 g | N9308212 |
| Lanthanum 1000 µg/g | La | hydrocarbon oil | 50 g | N9308213 |
| Lead 1000 µg/g | Pb | hydrocarbon oil | 50 g | N9308214 |
| Lithium 1000 µg/g | Li | hydrocarbon oil | 50 g | N9308215 |
| Magnesium 1000 µg/g | Mg | hydrocarbon oil | 50 g | N9308216 |
| Manganese 1000 µg/g | Mn | hydrocarbon oil | 50 g | N9308217 |
| Mercury 1000 µg/g | Hg | hydrocarbon oil | 50 g | N9308218 |
| Molybdenum 1000 µg/g | Mo | hydrocarbon oil | 50 g | N9308219 |
| Nickel 1000 µg/g | Ni | hydrocarbon oil | 50 g | N9308220 |
| Phosphorus 1000 µg/g | P | hydrocarbon oil | 50 g | N9308221 |
| Potassium 1000 µg/g | K | hydrocarbon oil | 50 g | N9308222 |
| Scandium 1000 µg/g | Sc | hydrocarbon oil | 10 g | N9308255 |
| Scandium 1000 µg/g | Sc | hydrocarbon oil | 50 g | N9308223 |
| Selenium 1000 µg/g | Se | hydrocarbon oil | 50 g | N9308224 |
| Silicon 1000 µg/g | Si | hydrocarbon oil | 50 g | N9308225 |
| Silver 1000 µg/g | Ag | hydrocarbon oil | 50 g | N9308226 |
| Sodium 1000 µg/g | Na | hydrocarbon oil | 50 g | N9308227 |
| Strontium 1000 µg/g | Sr | hydrocarbon oil | 50 g | N9308228 |
| Sulfur 10 µg/g | S | hydrocarbon oil | 50 g | N9308229 |
| Sulfur 100 µg/g | S | hydrocarbon oil | 50 g | N9308230 |
| Sulfur 1000 µg/g | S | hydrocarbon oil | 50 g | N9308231 |
| Thallium 1000 µg/g | Tl | hydrocarbon oil | 50 g | N9308232 |
| Tin 1000 µg/g | Sn | hydrocarbon oil | 50 g | N9308233 |
| Titanium 1000 µg/g | Ti | hydrocarbon oil | 50 g | N9308234 |
| Vanadium 1000 µg/g | V | hydrocarbon oil | 50 g | N9308235 |
| Yttrium 1000 µg/g | Y | hydrocarbon oil | 50 g | N9308236 |
| Yttrium 5000 µg/g | Y | hydrocarbon oil | 50 g | N9308323 |
| Zinc 1000 µg/g | Zn | hydrocarbon oil | 50 g | N9308237 |
| Zirconium 1000 µg/g | Zr | hydrocarbon oil | 50 g | N9308238 |

V-21 Wear Metal Standards

Includes: Ag, Al, B, Ba, Ca, Cd, Cr, Cu, Fe, Mg, Mn, Mo, Na, Ni, P, Pb, Si, Sn, Ti, V, Zn

| Description | Matrix | Size | Part No. |
|------------------------------------|-----------------|-------|-----------------|
| V-21 Wear Metals Standard 10 µg/g | hydrocarbon oil | 100 g | N9308300 |
| V-21 Wear Metals Standard 10 µg/g | hydrocarbon oil | 200 g | N9308301 |
| V-21 Wear Metals Standard 10 µg/g | hydrocarbon oil | 400 g | N9308324 |
| V-21 Wear Metals Standard 30 µg/g | hydrocarbon oil | 100 g | N9308302 |
| V-21 Wear Metals Standard 30 µg/g | hydrocarbon oil | 200 g | N9308303 |
| V-21 Wear Metals Standard 30 µg/g | hydrocarbon oil | 400 g | N9308325 |
| V-21 Wear Metals Standard 50 µg/g | hydrocarbon oil | 100 g | N9308304 |
| V-21 Wear Metals Standard 50 µg/g | hydrocarbon oil | 200 g | N9308305 |
| V-21 Wear Metals Standard 50 µg/g | hydrocarbon oil | 400 g | N9308326 |
| V-21 Wear Metals Standard 100 µg/g | hydrocarbon oil | 100 g | N9308306 |
| V-21 Wear Metals Standard 100 µg/g | hydrocarbon oil | 200 g | N9308307 |
| V-21 Wear Metals Standard 100 µg/g | hydrocarbon oil | 400 g | N9308327 |
| V-21 Wear Metals Standard 300 µg/g | hydrocarbon oil | 100 g | N9308308 |
| V-21 Wear Metals Standard 300 µg/g | hydrocarbon oil | 200 g | N9308309 |
| V-21 Wear Metals Standard 300 µg/g | hydrocarbon oil | 400 g | N9308328 |
| V-21 Wear Metals Standard 500 µg/g | hydrocarbon oil | 100 g | N9308310 |
| V-21 Wear Metals Standard 500 µg/g | hydrocarbon oil | 200 g | N9308311 |
| V-21 Wear Metals Standard 500 µg/g | hydrocarbon oil | 400 g | N9308329 |
| V-21 Wear Metals Standard 900 µg/g | hydrocarbon oil | 100 g | N9308312 |
| V-21 Wear Metals Standard 900 µg/g | hydrocarbon oil | 200 g | N9308313 |
| V-21 Wear Metals Standard 900 µg/g | hydrocarbon oil | 400 g | N9308330 |

V-21+K Wear Metal Standards

Includes: Ag, Al, B, Ba, Ca, Cd, Cr, Cu, Fe, K, Mg, Mn, Mo, Na, Ni, P, Pb, Si, Sn, Ti, V, Zn

| Description | Matrix | Size | Part No. |
|--------------------------------------|-----------------|-------|-----------------|
| V-21+K Wear Metals Standard 10 µg/g | hydrocarbon oil | 100 g | N9308355 |
| V-21+K Wear Metals Standard 10 µg/g | hydrocarbon oil | 200 g | N9308356 |
| V-21+K Wear Metals Standard 30 µg/g | hydrocarbon oil | 100 g | N9308357 |
| V-21+K Wear Metals Standard 30 µg/g | hydrocarbon oil | 200 g | N9308358 |
| V-21+K Wear Metals Standard 30 µg/g | hydrocarbon oil | 400 g | N9308371 |
| V-21+K Wear Metals Standard 50 µg/g | hydrocarbon oil | 100 g | N9308359 |
| V-21+K Wear Metals Standard 50 µg/g | hydrocarbon oil | 200 g | N9308360 |
| V-21+K Wear Metals Standard 50 µg/g | hydrocarbon oil | 400 g | N9308372 |
| V-21+K Wear Metals Standard 100 µg/g | hydrocarbon oil | 100 g | N9308361 |
| V-21+K Wear Metals Standard 100 µg/g | hydrocarbon oil | 200 g | N9308362 |
| V-21+K Wear Metals Standard 100 µg/g | hydrocarbon oil | 400 g | N9308373 |
| V-21+K Wear Metals Standard 300 µg/g | hydrocarbon oil | 100 g | N9308363 |
| V-21+K Wear Metals Standard 300 µg/g | hydrocarbon oil | 200 g | N9308364 |
| V-21+K Wear Metals Standard 500 µg/g | hydrocarbon oil | 100 g | N9308365 |
| V-21+K Wear Metals Standard 500 µg/g | hydrocarbon oil | 200 g | N9308366 |
| V-21+K Wear Metals Standard 500 µg/g | hydrocarbon oil | 400 g | N9308374 |
| V-21+K Wear Metals Standard 900 µg/g | hydrocarbon oil | 100 g | N9308367 |
| V-21+K Wear Metals Standard 900 µg/g | hydrocarbon oil | 200 g | N9308368 |

V-23 Wear Metal Standards

Includes: Ag, Al, B, Ba, Ca, Cd, Cr, Cu, Fe, K, Mg, Mn, Mo, Na, Ni, P, Pb, Sb, Si, Sn, Ti, V, Zn

| Description | Matrix | Size | Part No. |
|------------------------------------|-----------------|-------|-----------------|
| V-23 Wear Metals Standard 10 µg/g | hydrocarbon oil | 100 g | N9308239 |
| V-23 Wear Metals Standard 10 µg/g | hydrocarbon oil | 200 g | N0776109 |
| V-23 Wear Metals Standard 10 µg/g | hydrocarbon oil | 400 g | N9308315 |
| V-23 Wear Metals Standard 30 µg/g | hydrocarbon oil | 100 g | N9308241 |
| V-23 Wear Metals Standard 30 µg/g | hydrocarbon oil | 200 g | N9308242 |
| V-23 Wear Metals Standard 30 µg/g | hydrocarbon oil | 400 g | N9308316 |
| V-23 Wear Metals Standard 50 µg/g | hydrocarbon oil | 100 g | N9308243 |
| V-23 Wear Metals Standard 50 µg/g | hydrocarbon oil | 200 g | N0776104 |
| V-23 Wear Metals Standard 50 µg/g | hydrocarbon oil | 400 g | N9308317 |
| V-23 Wear Metals Standard 100 µg/g | hydrocarbon oil | 100 g | N9308245 |
| V-23 Wear Metals Standard 100 µg/g | hydrocarbon oil | 200 g | N0776105 |
| V-23 Wear Metals Standard 100 µg/g | hydrocarbon oil | 400 g | N9308318 |
| V-23 Wear Metals Standard 300 µg/g | hydrocarbon oil | 100 g | N9308247 |
| V-23 Wear Metals Standard 300 µg/g | hydrocarbon oil | 200 g | N9308248 |
| V-23 Wear Metals Standard 300 µg/g | hydrocarbon oil | 400 g | N9308319 |
| V-23 Wear Metals Standard 500 µg/g | hydrocarbon oil | 100 g | N9308249 |
| V-23 Wear Metals Standard 500 µg/g | hydrocarbon oil | 200 g | N0776106 |
| V-23 Wear Metals Standard 500 µg/g | hydrocarbon oil | 400 g | N9308320 |
| V-23 Wear Metals Standard 900 µg/g | hydrocarbon oil | 100 g | N9308251 |
| V-23 Wear Metals Standard 900 µg/g | hydrocarbon oil | 200 g | N9308252 |
| V-23 Wear Metals Standard 900 µg/g | hydrocarbon oil | 400 g | N9308321 |

Internal Standards

| Description | Matrix | Size | Part No. |
|--|-----------------|-------|-----------------|
| Cobalt (Co) Internal Standard, 6% | mineral spirits | 200 g | N0776107 |
| Cobalt (Co) Internal Standard, 6% | mineral spirits | 400 g | N9308334 |
| Cobalt (Co) Internal Standard, 5000 µg/g | hydrocarbon oil | 50 g | N9308258 |
| Cobalt Sulfur-Free Metallo-Organic Concentrate: Co @ approx 3% | hydrocarbon oil | 400 g | N9304168 |



Metal Additive Standards

| Description | Matrix | Size | Part No. |
|---|-----------------|-------|-----------------|
| Metal Additive Standard 3: Ca @ 5000 µg/g; P, Zn @ 1600 µg/g | hydrocarbon oil | 100 g | N9308369 |
| Metal Additive Standard 3: Ca @ 5000 µg/g; P, Zn @ 1600 µg/g | hydrocarbon oil | 200 g | N9308370 |
| Metal Additive Standard 3: Ca @ 5000 µg/g; P, Zn @ 1600 µg/g | hydrocarbon oil | 400 g | N9308552 |
| Metal Additive Standard 4: Ca @ 5000 µg/g; Mg, P, Zn @ 1600 µg/g | hydrocarbon oil | 100 g | N9308259 |
| Metal Additive Standard 4: Ca @ 5000 µg/g; Mg, P, Zn @ 1600 µg/g | hydrocarbon oil | 200 g | N0776108 |
| Metal Additive Standard 4: Ca @ 5000 µg/g; Mg, P, Zn @ 1600 µg/g | hydrocarbon oil | 400 g | N9308333 |



V-Solv™ ICP Solvent 1 Gallon



V-Solv™ ICP Solvent 5 Gallon

V-Solv™ ICP Solvent is a proprietary solvent that is used for diluting oil and other organic liquids for analysis by ICP and ICP-MS. Use V-Solv™ as a matrix blank and as a diluent for your calibration standards and samples for outstanding nebulization characteristics.

Citrajel cleaner is ideal for use in labware washers, manual and ultrasonic cleaning. Use on glassware, metals, plastics, ceramics, porcelain, rubber and fiberglass. Corrosion inhibiting formula removes metal oxides, scale, salts, inorganic residues, trace metals and amphoteric proteins. Suitable for acid washing and rinsing.

Matrix Oils and Solvents

| Description | Matrix | Size | Part No. |
|-------------------------------|--------------------|----------|-----------------|
| Hydrocarbon Oil | 75 cSt oil | 500 mL | N0776103 |
| Hydrocarbon Oil | 75 cSt oil | 1 Gal. | N9308262 |
| Mineral Oil (low sulfur) | 20 cSt mineral oil | 500 mL | N9308263 |
| Mineral Oil (low sulfur) | 20 cSt mineral oil | 1/2 Gal. | N9308264 |
| V-Solv™ ICP Solvent | hydrocarbon oil | 1 Gal. | N9308265 |
| V-Solv™ ICP Solvent | hydrocarbon oil | 5 Gal. | N9308378 |
| Citrajel® Liquid Acid Cleaner | | 1 Gal. | N0777063 |
| Citrajel® Liquid Acid Cleaner | | 5 Gal. | N0777064 |

Fuel Dilution Standards

| Description | Matrix | Size | Part No. |
|--|------------------------|--------|-----------------|
| Blank for Diesel Fuel Dilution Standard | 75 cSt hydrocarbon oil | 100 mL | N9308266 |
| 2% (v/v) Devolatilized Diesel Fuel in Hydrocarbon Oil | 75 cSt hydrocarbon oil | 100 mL | N9308267 |
| 4% (v/v) Devolatilized Diesel Fuel in Hydrocarbon Oil | 75 cSt hydrocarbon oil | 100 mL | N9308297 |
| 5% (v/v) Devolatilized Diesel Fuel in Hydrocarbon Oil | 75 cSt hydrocarbon oil | 100 mL | N9308268 |
| 10% (v/v) Devolatilized Diesel Fuel in Hydrocarbon Oil | 75 cSt hydrocarbon oil | 100 mL | N9308269 |
| Blank for Gas Fuel Dilution Standard | 75 cSt hydrocarbon oil | 100 mL | N9308270 |
| 2% (v/v) Devolatilized Gasoline in Hydrocarbon Oil | 75 cSt hydrocarbon oil | 100 mL | N9308271 |
| 5% (v/v) Devolatilized Gasoline in Hydrocarbon Oil | 75 cSt hydrocarbon oil | 100 mL | N9308272 |
| 10% (v/v) Devolatilized Gasoline in Hydrocarbon Oil | 75 cSt hydrocarbon oil | 100 mL | N9308273 |
| Blank | 20 cSt hydrocarbon oil | 100 mL | N9308274 |

Acid Number Standards

| Description | Matrix | Size | Part No. |
|---|-----------------|-------|-----------------|
| Acid Number (AN) Reference Material, 0.1 mg KOH/g | hydrocarbon Oil | 100 g | N9308160 |
| Acid Number (AN) Reference Material, 0.1 mg KOH/g | hydrocarbon Oil | 400 g | N9308161 |
| Acid Number (AN) Reference Material, 1 mg KOH/g | hydrocarbon Oil | 100 g | N9308162 |
| Acid Number (AN) Reference Material, 1 mg KOH/g | hydrocarbon Oil | 400 g | N9308163 |
| Acid Number (AN) Reference Material, 1.5 mg KOH/g | hydrocarbon Oil | 100 g | N9308164 |
| Acid Number (AN) Reference Material, 1.5 mg KOH/g | hydrocarbon Oil | 400 g | N9308165 |
| Acid Number (AN) Reference Material, 0.5 mg KOH/g | hydrocarbon Oil | 100 g | N9308166 |
| Acid Number (AN) Reference Material, 0.5 mg KOH/g | hydrocarbon Oil | 400 g | N9308167 |
| Acid Number (AN) Reference Material, 3 mg KOH/g | hydrocarbon Oil | 50 g | N9308168 |
| Acid Number (AN) Reference Material, 3 mg KOH/g | hydrocarbon Oil | 400 g | N9308169 |
| Acid Number (AN) Reference Material, 2 mg KOH/g | hydrocarbon Oil | 50 g | N9308170 |

Base Number Standards

| Description | Matrix | Size | Part No. |
|--|-----------------|-------|-----------------|
| Base Number (BN) Reference Material, 10 mg KOH/g | hydrocarbon Oil | 50 g | N9308555 |
| Base Number (BN) Reference Material, 10 mg KOH/g | hydrocarbon Oil | 400 g | N9308173 |
| Base Number (BN) Reference Material, 15 mg KOH/g | hydrocarbon Oil | 50 g | N9308174 |
| Base Number (BN) Reference Material, 30 mg KOH/g | hydrocarbon Oil | 50 g | N9308176 |
| Base Number (BN) Reference Material, 30 mg KOH/g | hydrocarbon Oil | 400 g | N9308177 |
| Base Number (BN) Reference Material, 40 mg KOH/g | hydrocarbon Oil | 50 g | N9308178 |
| Base Number (BN) Reference Material, 6 mg KOH/g | hydrocarbon Oil | 50 g | N9308554 |
| Base Number (BN) Reference Material, 6 mg KOH/g | hydrocarbon Oil | 400 g | N9308181 |
| Base Number (BN) Reference Material, 70 mg KOH/g | hydrocarbon Oil | 50 g | N9308182 |



Karl Fischer Standards

| Nominal Water Concentration (%) | Matrix | Size | Part No. |
|----------------------------------|-----------------|-------|-----------------|
| Karl Fischer Water in Oil, Blank | 10W30 motor oil | 50 g | N9308278 |
| Karl Fischer Water in Oil, 0.1% | 10W30 motor oil | 400 g | N9308279 |
| Karl Fischer Water in Oil, 0.5% | 10W30 motor oil | 50 g | N9308280 |
| Karl Fischer Water in Oil, 1.0% | 10W30 motor oil | 50 g | N9308281 |

Soot Content Standards

| Nominal Water Concentration (%) | Matrix | Size | Part No. |
|------------------------------------|------------------|-------|-----------------|
| Nominal Soot Content Range: Blank | 15W40 diesel oil | 50 mL | N9308282 |
| Nominal Soot Content Range: 0.5-2% | 15W40 diesel oil | 50 mL | N9308283 |
| Nominal Soot Content Range: 2-4% | 15W40 diesel oil | 50 mL | N9308284 |
| Nominal Soot Content Range: 4-6% | 15W40 diesel oil | 50 mL | N9308285 |

Biodiesel Standards

| Description | Matrix | Size | Part No. |
|--|----------------|--------|-----------------|
| Biodiesel Blank | B100 biodiesel | 100 mL | N9308286 |
| Biodiesel Blank | B100 biodiesel | 500 mL | N9308287 |
| Sulfur @ 20 µg/g in Biodiesel | B100 biodiesel | 100 mL | N9308288 |
| Metals in Biodiesel – Ca, K, Mg, Na, P @ 20 µg/g | B100 biodiesel | 100 g | N9308289 |
| Metals in Biodiesel - Ca, K, Mg, Na, P @ 5µg/g | B100 Biodiesel | 100 g | N9308726 |

Coolant Standards

| Description | Matrix | Size | Part No. |
|---|--------|-------|-----------------|
| Custom HI 1A: Al @ 10µg/mL; Mg @ 20µg/mL; Ca @ 32µg/mL; Cu, Fe, Pb, Zn @ 50µg/mL; B @ 1000µg/mL; P @ 2000µg/mL; K @ 5000µg/mL; Na @ 10,000µg/mL 3% HNO3 (v/v) | | 500mL | N9308341 |
| Custom QC 1A: Al, Cu @ 5µg/mL; Mg @ 10µg/mL; Zn @ 20µg/mL; Fe, Pb @ 25µg/mL; Ca @ 50µg/mL; B @ 250µg/mL; P @ 1000µg/mL; K @ 2500µg/mL; Na @ 5000µg/mL 3% HNO3 (v/v) | | 500mL | N9308342 |
| Custom LO 1A: Al, Cu @ 2µg/mL; Mg, Zn @ 4µg/mL; Fe @ 5µg/mL; Ca, Pb @ 10µg/mL; B @ 50µg/mL; P @ 400µg/mL; K, Na @ 1000µg/mL 3% HNO3 (v/v) | | 500mL | N9308343 |
| Custom QC 1B: Sn @ 10µg/mL; Si @ 30µg/mL; Mo @ 50µg/mL 3% HNO3 (v/v)/tr HF 500mL | | 500mL | N9308344 |
| Custom LO 1B: Sn @ 5µg/mL; Si @ 10µg/mL; Mo @ 20µg/mL 3% HNO3 (v/v)/tr HF | | 500mL | N9308345 |
| Custom HI 1B: Sn @ 20µg/mL; Mo, Si @ 100µg/mL 3% HNO3 (v/v)/tr HF | | 500mL | N9308346 |

Sulfur Standards

| Description | Matrix | Size | Part No. |
|--|--------------------|--------|-----------------|
| Polysulfide Oil Blank | 13 cSt Mineral Oil | 500 mL | N9308390 |
| Sulfur @ 500 µg/g, from Polysulfide Oil | 13 cSt Mineral Oil | 500 mL | N9308391 |
| Sulfur @ 1000 µg/g, from Polysulfide Oil | 13 cSt Mineral Oil | 500 mL | N9308392 |
| Sulfur @ 5000 µg/g, from Polysulfide Oil | 13 cSt Mineral Oil | 500 mL | N9308393 |
| Sulfur @ 1 wt%, from Polysulfide Oil | 13 cSt Mineral Oil | 500 mL | N9308394 |
| Sulfur @ 5 wt%, from Polysulfide Oil | 13 cSt Mineral Oil | 500 mL | N9308395 |
| Sulfur @ 0 µg/g (Blank) | #2 Diesel Fuel | 500 mL | N9308714 |
| Sulfur @ 5 µg/g, from Polysulfide Oil | #2 Diesel Fuel | 500 mL | N9308715 |
| Sulfur @ 10 µg/g, from Polysulfide Oil | #2 Diesel Fuel | 500 mL | N9308716 |
| Sulfur @ 15 µg/g, from Polysulfide Oil | #2 Diesel Fuel | 500 mL | N9308717 |
| Sulfur @ 20 µg/g, from Polysulfide Oil | #2 Diesel Fuel | 500 mL | N9308718 |
| Sulfur @ 25 µg/g, from Polysulfide Oil | #2 Diesel Fuel | 500 mL | N9308719 |
| Sulfur @ 50 µg/g, from Polysulfide Oil | #2 Diesel Fuel | 500 mL | N9308720 |
| Sulfur @ 100 µg/g, from Polysulfide Oil | #2 Diesel Fuel | 500 mL | N9308721 |
| Sulfur @ 500 µg/g, from Polysulfide Oil | #2 Diesel Fuel | 500 mL | N9308722 |
| Sulfur @ 1000 µg/g, from Polysulfide Oil | #2 Diesel Fuel | 500 mL | N9308723 |
| Sulfur @ 1500 µg/g, from Polysulfide Oil | #2 Diesel Fuel | 500 mL | N9308724 |



OilExpress Standards

| Description | Matrix | Size | Part No. |
|---|------------------|--------|-----------------|
| In-Service Lubricants FT-IR Control Standard | 15W40 Diesel Oil | 100 g | N9308350 |
| In-Service Lubricants FT-IR Control Standard | 15W40 Diesel Oil | 500 g | N9308375 |
| OilExpress 4 Test Oil 120 cSt | PAO Oils | 500 g | N9308351 |
| OilExpress 4 Test Oil 360 cSt | PAO Oils | 100 g | N9308352 |
| OilExpress 4 System Liquid Detergent Additive | | 100 g | N9308354 |
| OilExpress 4 System Liquid Detergent Additive | | 500 mL | N9308376 |
| OilExpress 4 System Liquid Detergent Additive | | 1 Gal. | N9308380 |
| Pathlength Calibration Fluid (Squalane) | | 50 mL | N9308377 |
| OilExpress 4 Installation Kit (includes N9308350, N9308351, N9308352, N9308354, and N9308377) | | Kit | N9300850 |

Biodiesel Blends for IR

| Description | Matrix | Size | Part No. |
|-------------------------|-------------------------|-------|-----------------|
| 100% High Cetane Diesel | High Cetane Diesel Fuel | 20 mL | N9308290 |
| 2% (v/v) Biodiesel | High Cetane Diesel Fuel | 20 mL | N9308291 |
| 5% (v/v) Biodiesel | High Cetane Diesel Fuel | 20 mL | N9308292 |
| 10% (v/v) Biodiesel | High Cetane Diesel Fuel | 20 mL | N9308293 |
| 15% (v/v) Biodiesel | High Cetane Diesel Fuel | 20 mL | N9308294 |
| 20% (v/v) Biodiesel | High Cetane Diesel Fuel | 20 mL | N9308295 |
| 100% (v/v) Biodiesel | B100 biodiesel | 20 mL | N9308296 |

Viscosity Reference Standards



Viscosity Reference Standards

| Description | Matrix | Size | Part No. |
|---|--------------|------------|-----------------|
| Viscosity Standard Reference Kit | Hydrocarbons | 5 x 500 mL | N5316000 |
| Nominal Viscosity: 4.5 cSt at 40 °C, and 1.6 cSt at 100 °C | Hydrocarbons | 500 mL | N9307740 |
| Nominal Viscosity: 10 cSt at 40 °C, and 2.7 cSt at 100 °C | Hydrocarbons | 500 mL | N5316001 |
| Nominal Viscosity: 30 cSt at 40 °C, and 5.3 cSt at 100 °C | Hydrocarbons | 500 mL | N5316002 |
| Nominal Viscosity: 30 cSt at 40 °C, and 5.3 cSt at 100 °C | Hydrocarbons | 1 Gal. | N5316025 |
| Nominal Viscosity: 100 cSt at 40 °C, and 16.8 cSt at 100 °C | Hydrocarbons | 500 mL | N5316003 |
| Nominal Viscosity: 100 cSt at 40 °C, and 16.8 cSt at 100 °C | Hydrocarbons | 1 Gal. | N5316024 |
| Nominal Viscosity: 360 cSt at 40 °C, and 42 cSt at 100 °C | Hydrocarbons | 500 mL | N5316004 |
| Nominal Viscosity: 930 cSt at 40 °C, and 82 cSt at 100 °C | Hydrocarbons | 500 mL | N5316005 |

Proficiency Testing Standards



Proficiency Testing Standards

Proficiency Testing Program

The Proficiency Testing Program offered by PerkinElmer has been designed to provide laboratories with a method of monitoring their analytical performance as measured against Certified Reference Materials (CRMs).

1. Analyze a sample
2. Report the results online
3. Receive an instant response to submitted values

Confirm the accuracy of your analytical results, quickly, easily, and definitively.

| Description | Size | Part No. |
|---|------|-----------------|
| PTP Standard for Elemental Analysis of Oils | 25 g | N9308314 |

Note: Analyze a sample for up to 23 common elements and report the concentrations in µg/g (ppm). Enter all elements or only those that are of interest to you. Results are color-coded pass/fail indications in green (pass), yellow (borderline), and red (fail).

| Description | Size | Part No. |
|------------------------------------|--------|-----------------|
| Sample for Particle Count Analysis | 125 mL | N9308725 |

Note: Particle Count PTP test standard includes 8 channels (4, 6, 8, 14, 21, 38, 50 and 70 µm). One bottle for ISO 11171 only.

| Description | Size | Part No. |
|-----------------------------|-------|-----------------|
| Viscosity PTP Test Standard | 50 mL | N9308540 |

Note: Report viscosity values in cSt at 40 °C, 100 °C, or both.

PolyScience® WhisperCool™ Refrigerated Chiller

The PolyScience® WhisperCool® Refrigerated Chiller is designed to deliver quiet and reliable performance over a broad range of operating temperatures and conditions. Extremely dependable and energy efficient, it features a -10 to 40 °C operating temperature range, built-in process and equipment protection, and highly intuitive user interface. This chiller is designed for use on both ICP-OES and ICP-MS instruments.

Key Advantages

- 50% quieter operation than comparable models (62 dB*)
- 2900 watts (9889 BTU/hour) cooling capacity
- Built-in temperature, pressure, and flow rate alarms

* WhisperCool® environmental control reduces operational noise (62 dB)

ICP Chiller Coolant Mix
Part No: N0776099



Ordering Information

| Part No. | N0772046 | N0772045 |
|--|---|--|
| Electrical Requirements | 208-230 V, 60 Hz, 12.2 A | 240 V, 50 Hz, 12.2 A |
| Operating Temperature Range | -10 to 40 °C | -10 to 40 °C |
| Temperature Stability | ±0.1 °C (±1.8 °F) | ±0.1 °C (±1.8 °F) |
| Cooling Capacity | at 20 °C: 2900 Watts (9889 BTU/hr) at 10 °C: 1925 Watts (6574 BTU/hr) at 0 °C: 1000 Watts (3410 BTU/hr) | 2650 Watts (9889 BTU/hr) 1900 Watts (6574 BTU/hr) 1200 Watts (3410 BTU/hr) |
| Compressor | 1.0 HP | 1.0 HP |
| Reservoir Capacity | 4.2 L | 4.2 L |
| Pump Type | Turbine | Turbine |
| Maximum Pump Pressure | 90 PSI | 83 PSI |
| Maximum Pump Flow | 13.2 LPM | 13.2 LPM |
| Dimensions | 22 5/8 x 14 1/2 x 27 5/8 in / 57.6 x 36.8 x 70.2 cm | |
| Shipping Weight | 189 lb / 85.7 kg | |
| Replacement Air Filter | N0777095 (Air Filter with Frame, 13 x 14 in) | |
| ICP Chiller Coolant Mix | N0776099 (Five Half-gallon bottles) | |
| ICPMS Chiller Coolant Mix | WE016558 (1 liter bottles) for ELAN/NexION | |
| Stainless Steel Strainer for Reservoir | N0691907 | |

At-a-glance access to pressure and flow rate information

Adaptive environmental technology optimizes compressor and evaporator performance to reduce overall energy consumption

Smart electronics control fan speed based on cooling demand, reducing operating noise by as much as 50%

Louvered side and rear vents for added noise dampening

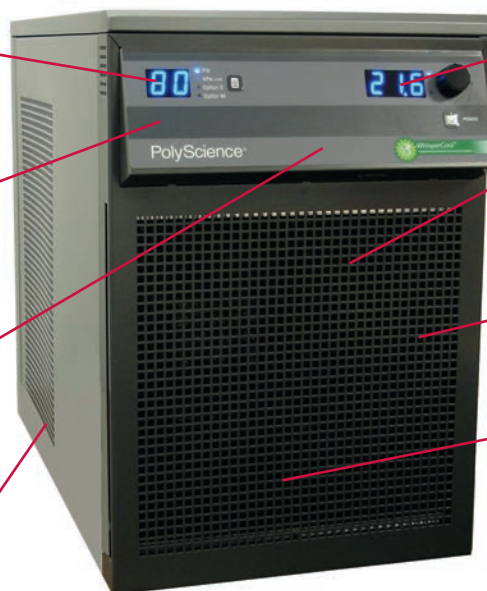

±0.1 °C temperature stability

High performance turbine pump with vibration isolators for quiet fluid flow

Compact portable design

Washable air filter removes quickly for easy cleaning



Heat Exchanger System

Cooling systems for the ELAN 9000/DRC II/e/NexION systems. Air cooled recirculator without refrigeration. Not to be placed in areas with temperatures above 30 °C (86 °F). Requires the use of Coolant Fluid (WE016558).

| ICP-MS Power Requirement | Part No. |
|--------------------------|-----------------|
| 120 V, 60 Hz | N8122248 |
| 220/250 V, 50/60 Hz | N8122247 |

NOISE ENCLOSURES



For NexION® Leybold SV40 Vacuum Pump

| External Dimensions | Centimeters | Inches |
|----------------------|-------------|--------------|
| Depth | 67.4 | 26.5 |
| Width | 45.6 | 17.95 |
| Height | 55 | 21.65 |
| Height with oil tray | 64.6 | 25.39 |
| Weight | Kilograms | Pounds (lbs) |
| Enclosure | 14 | 30.8 |
| Oil tray | 8 | 16.75 |

| Description | Part No. |
|--|-----------------|
| Noise enclosure (dolly not included) | N8121068 |
| Noise enclosure with Built-in Overheating Temperature Alarm (dolly not included) | N8145407 |
| Noise enclosure dolly (option) | N8121069 |
| Noise reduction cover (dolly not included) | MZ321146 |
| Noise reduction cover dolly (option) | MZ321147 |



Vacuum Pump
Noise Enclosure



Vacuum Pump
Noise Reduction Cover

Noise Enclosures for Vacuum Pumps and Chillers

Laboratories can be loud and noise in labs is distracting, stressful and potentially harmful to your hearing. While noise in labs may not be frequently talked about, it is something you should be concerned with.

Our noise reduction enclosures are designed specifically for your instrument. They provide noise reduction performance from -12 db(A) up to -20 db(A), equivalent to a 75% reduction in noise perception! Thick 50 mm Polyurethane acoustic open cell foam covers the interior part of the enclosure, delivering good noise absorption. The wave shape of the foam multiplies the absorption capacity, providing you with a quieter, safer lab. Each noise enclosure has efficient air circulation, is easy-to-install and maintain and is compatible with all electrical outlets worldwide.

Chiller Noise Enclosure Key Advantages

- Performance: average sound level decrease is - 15 dB(A) (equivalent to a 75% reduction in noise perception).
- Environment friendly noise adsorbing material, oil and water resistant.
- Heat exchange controlled by six internal silent fans.
- Worldwide electrical compatibility-enclosures are delivered with European, US, Japan, and UK plugs.
- Easy access to front monitor and switch (the transparent window can be opened).
- Easy water level check (window on the back panel).
- Includes Overheating temperature alarm.
- The noise reduction is in conformity with the European directive related to low voltage equipment(2006/95/EC) and electromagnetic compatibility (2004/108/EC).
- Power supply Csa, Ce and Ccc

For Model: Polyscience 6000 Series

| External Dimensions | Centimeters | Inches |
|---------------------|-------------|--------|
| Depth | 88 | 34.7 |
| Width | 57 | 23.7 |
| Height | 71 | 30.7 |

| Description | Part No. |
|-------------------|----------------|
| Chiller Enclosure | N077920 |



POWER CONDITIONERS AND UPS SYSTEMS

Damaged or compromised components, disrupted processes, lack of reliability – they all add up to frustration, broken schedules and costly downtime. The problem is caused by a host of power disturbances – some visible and many invisible – that threaten

your equipment’s operation every year. Power “disturbances” are simply those large and small variations in the quality of the electric power you use day in and day out. Some come from your local utility company, but most are created within your own facility as a result of the distribution and use of electrical power. These variations include high-energy voltage transients, sags and swells, electrical noise, and common mode voltage, as well as the power outages everyone witnesses when the lights go out.

Power Conditioners

| Instrument Model | Description | Frequency (Hz) | Part No. |
|--|-------------|----------------|-----------------|
| ATOMIC ABSORPTION | | | |
| AAAnalyst™ 100/200/300/400 | 520 VA | 60 | N9307504 |
| AAAnalyst 100/200/300/400/PinAAcle™ 900 F | 750 VA | 50 | N9307521 |
| AAAnalyst 600/800 | 5.8 kVA | 60 | N9307511 |
| AAAnalyst 600/800 | 6.0 kVA | 50 | N9307523 |
| AAAnalyst 700 | 3.8 kVA | 60 | N9307509 |
| AAAnalyst 700 | 3.6 kVA | 50 | N9307522 |
| PinAAcle 900 H/T/Z | 5.8 kVA | 60 | N9307760 |
| PinAAcle 900 H/T/Z | 6.0 kVA | 50 | N9307523 |
| PinAAcle 900F | 720 VA | 60 | N9307515 |
| ICP-OES | | | |
| Optima™ 2x00/4x00/5x00/7x00/8x00 | 3.8 kVA | 60 | N9307512 |
| Optima 2x00/4x00/5x00/7x00/8x00 | 3.6 kVA | 50 | N9307522 |
| ICP-MS | | | |
| ELAN® 6x00/9000 Controller Side | 3.8 kVA | 60 | N9307519 |
| ELAN 6x00/9000 Controller Side | 3.6 kVA | 50 | N9307522 |
| AAAnalyst 600/800/ELAN 6x00/9000 RF Generator Side | 5.8 kVA | 60 | N9307511 |
| ELAN 6x00/9000/NexION® RF Generator Side | 6.0 kVA | 50 | N9307523 |
| NexION | 5.0 kVA | 60 | N0777690 |
| TITAN MPST™ | | | |
| Titan MPS | 2.0 kVA | 60 | N9306758 |
| Titan MPS | 2.0 kVA | 50 | N9306755 |



On-Line Conditioned Uninterruptible Power Supply Systems

With the Security Plus Series, you get much more protection and a higher comfort level than you get with most other UPS systems. The Security Plus Series also provides complete power conditioning and, because the Security Plus Series features on-line inverter design, added peace of mind. And regardless of input fluctuations, the Security Plus Series insures that the output remains continuous and regulated.

UPS Systems

| Instrument Model | Description | Frequency (Hz) | Part No. |
|---|-------------|----------------|-----------------|
| ATOMIC ABSORPTION | | | |
| PinAAcle 900F/AAAnalyst 100/200/300/400 | 800 VA | 60 | N0777681 |
| PinAAcle 900F/AAAnalyst 100/200/300/400 | 800 VA | 50 | N0777689 |
| AAAnalyst 700/HGA 900 | 5.2 kVA | 50/60 | N9308150 |
| PinAAcle 900 T/H/Z | 10 kVA | 50/60 | N9306757 |
| AAAnalyst 600/800 | 10 kVA | 50/60 | N0777613 |
| ICP-OES | | | |
| Optima 2x00/4x00/5x00/7x00/8x00 | 5.2 kVA | 50/60 | N0777511 |
| ICP-MS | | | |
| NexION | 8.0 kVA | 50/60 | N0777682 |
| ELAN | 12 kVA | 50/60 | N0777719 |



TESTED AND APPROVED

Acetylene Regulator

For AA labs, this regulator includes an adapter so that the pressure regulator can be connected to cylinders requiring either CGA 300 or CGA 510 fittings and a connector for attaching the fuel hose assembly supplied with the instrument. Includes hose assembly.



| Description | Part No. |
|------------------------------|----------|
| Max Inlet Pressure: 400 psig | 03030106 |

Air Regulator

For AA labs. Regulator to cylinder CGA no. 590. Includes hose assembly.



| Description | Part No. |
|--------------------------------|----------|
| Max Inlet Pressure: 3,000 psig | 03030264 |

Nitrous Oxide Regulator

For use in AA labs with gas cylinders with a CGA 326 connection. Provides pressure control from 350–520 kPa (50–75 psig) and contains an integral thermostatted heater to prevent freezing of the regulator diaphragm.



| Description | Part No. |
|-------------|----------|
| 115 V | 03030204 |
| 220 V | 03030349 |

Argon/Nitrogen Regulator

For AA and ICP, this regulator can be used with argon or nitrogen and has a CGA 580 fitting. A color-coded hose with ¼" SWAGELOK® fittings is also included.



| Description | Part No. |
|--------------------------------|----------|
| Max Inlet Pressure: 3,000 psig | 03030284 |

Matheson Flashback Arrestor

Because acetylene is an extremely unstable gas, users can experience flashbacks at the instrument burner head. The flash arrestor prevents these potentially dangerous flashbacks from reaching the regulator or cylinder.



| Description | Part No. |
|---|----------|
| Acetylene Max Operating Pressure: 15 psig | N9300068 |

Hose Assemblies

Hose assemblies for connecting fuel, air and nitrous oxide from supply to instrument.



| Description | Part No. |
|--|----------|
| Acetylene, Red Neoprene, 3.7 m (12 ft) | 00570559 |
| Air/Argon, Black, 3.7 m (12 ft) | 00570567 |
| Nitrous Oxide, Blue, 3.7 m (12 ft) | 00470258 |

Blower and Vent Assembly for AA and ICP

A venting system is required to remove fumes and vapors from the torch of ICP emission spectrometers. A vent is recommended for use over the power supply unit of most ICP spectrometers for removal of dissipated heat. Use exhaust venting to:

- Protect lab personnel from toxic vapors
- Protect your instrument from corrosive vapors
- Improve stability of the ICP torch



Includes Exhaust Hood, Adapter and Blower. Does not include ducting. PerkinElmer service engineers are not permitted to install this unit.

| Description | Part No. |
|-------------|----------|
| 110 V | 03030447 |
| 230 V | 03030448 |

Parker Balston® 73-099 AA Gas Purifier

For AA labs, this wall-mounted system designed to purify the compressed air and acetylene gases used in atomic absorption. It consists of two independent filtration systems, one for compressed air and one for acetylene. The unit also has a flashback arrestor on the acetylene line and a pressure regulator on the compressed air line.



The 2-stage air filtration assembly consists of a Balston Grade DX coalescing filter and a Balston Grade BX coalescing filter. Together these filters remove oil, water and particulate contamination (99.99% at 0.01 micron) from the compressed air supply.

| Description | Part No. |
|---------------------------------------|-----------------|
| Parker Balston 73-099 AA Gas Purifier | N9301398 |

Parker Balston® Replacement Filters

| Description | Cartridges Part No. | Seal Sets Part Part No. |
|------------------|---------------------|-------------------------|
| 1st Air Filter | N9301710 | N9301712 |
| 2nd Air Filter | N9301711 | N9301712 |
| Acetylene Filter | N9301714 | N9301715 |

Balston® 95A Acetylene Filter

For your AA lab, this filter includes a Balston Grade BQ filter cartridge to remove liquid and solid contaminants from the acetylene supply to 99.99% at 0.01 micron. Max working pressure: 15 psig.



| Description | Part No. |
|--|-----------------|
| Acetylene Filter | N9301399 |
| Replacement Acetylene Filter Cartridge | N9301714 |

Balston® Air Filter Assembly Type A-82

For AA and ICP labs, this filter is specifically designed to remove water, oil and dirt particles down to 0.6 microns in diameter from compressed air lines. It is recommended for use with oil-type compressors and for removing moisture and dirt particles from air supplied by oil-less compressors. Also recommended to filter argon for the PinAAcle furnace.



| Description | Part No. |
|--------------------------------------|-----------------|
| Air Filter Assembly | N0580531 |
| Replacement Filter Cartridge Element | N0582251 |

Air Dryer Filter Assembly with R250 Regulator

To filter compressed air for AA and ICP instrumentation. Replaces 00470652 and N0770198.



| Description | Part No. |
|---|-----------------|
| Air Dryer Filter Assembly with R250 Regulator | N0775325 |
| Replacement Filter Element | N9306067 |
| Float Assembly | N0777710 |
| Bowl O-Ring | N0777328 |

Wilkerson® Air Dryer Filter Accessories*

| Description | Pre-Filter Part Part No. | Final Filter Part No. |
|-------------------------------|--------------------------|-----------------------|
| Filter Elements | 09923464 | 09907120 |
| Filter Bowls | N9302199 | N9302199 |
| Bowl O-Ring Kit, Final Filter | N9302197 | N9301715 |

* For Wilkerson Filter PerkinElmer (00470652)

ICP Filter Replacement Parts

| ICP Model | Filter Element | Part No. |
|-------------------------------|--|-----------------|
| 2x00/3x00/4x00/5x00/7x00/8x00 | Air filter in front of spectrometer fan | 09995098 |
| 2x00/3x00/4x00 | Water Filter | 09904845 |
| 2x00/3x00/4x00 | Cartridge for Water Filter | 09904846 |
| 2x00/4x00/5x00/7x00/8x00 | Air Filter for the RF Generator Inlet | N0775220 |
| 3x00 | Washable Air Filter for the RF Generator Inlet | 02509115 |
| 3x00 | Disposable Air Filter for the RF Generator Inlet | 09923517 |

Instrument Filters

| Description | Part No. |
|--|-----------------|
| For AAAnalyst 100/300/PinAAcle 900 | 09995097 |
| For AAAnalyst 200/400/600/700/800 | B0501696 |
| For AAAnalyst 600/700/800 (80x80) | B0502706 |
| For Optima 2x00/3x00/4x00/5x00/7x00/8x00 | 09995098 |
| For NexION (left) | W1036712 |
| For NexION (back right) | W1036713 |

Polyscience Replacement Air Filters

| Description | Part No. |
|-----------------------------------|-----------------|
| Polyscience Air Filter | N0777359 |
| Polyscience Air Filter with Frame | N0777095 |
| Heat Exchanger Air Filter | N0777360 |

SAMPLE PREPARATION BLOCK SYSTEMS



PerkinElmer offers a variety of sample preparation blocks and accessories for your lab needs.

Better laboratory practices demand modern techniques in sample preparation. In the past, hot plates were used to digest samples where common digestion problems involved rusting, cross contamination of digestion system to sample, and poor sample temperature control.

With no exposed metal components and an outer shell manufactured from acid-resistant thermoplastic, the SPB blocks reduce the chances of sample contamination. Each system is constructed with a solid, PTFE-coated, graphite block where a flat heater covers 95% of the block's base. This guarantees temperature uniformity and eliminates hot spots found in hot plates.

All PerkinElmer sample preparation blocks are manufactured to specific tolerances which operates under a Quality Management System that is certified ISO 9001:2008.

Features and Benefits

- Ideal for any digestion/heating method which requires a temperature below 180 °C.
- Provides uniform temperature (± 1.0 °C across the block).
- Delivers even sample evaporation results.
- PTFE-coated graphite block resists aggressive, corrosive attack.
- Choose from 8 different SPB blocks.

“The major advantage of the PerkinElmer Sample Preparation Block is its ability to provide me with accurate temperature across the entire block.

With every run, I am confident that I have excellent recovery rates from my samples and there is no chance of contamination – which is critical when I'm conducting lead testing on my ICP-AES.”

Michigan Department of Community Health
Mark Knottnerus
Trace Metals Manager

Sample Preparation Blocks

The SPB series of block digestion systems offers the latest in graphite block technology in many different packages. Graphite blocks are PTFE-coated to resist aggressive corrosive attack for guaranteed long life in harsh laboratory environments.

Our sample blocks operate with either a SPB Digital Controller or SPB Touch Controller*. Please select a controller below and the appropriate Start Up Kit* which includes RackLock DigiTUBE®, disposable watch glasses, DigiFILTER™s and much more. Each SPB Block includes one set of racks.

Sample Preparation Blocks

| Description | Capacity | Part No. |
|---------------------------|-----------------|----------|
| SPB 15-40, (115 V/230 V) | 40 Tubes/15 mL | N9308709 |
| SPB 15-108, (115 V/230 V) | 108 Tubes/15 mL | N9308710 |
| SPB 50-24, (115 V/230 V) | 24 Tubes/50 mL | N9308019 |
| SPB 100-12, (115 V/230 V) | 12 Tubes/100 mL | N9308010 |
| SPB 50-48, (115 V/230 V) | 48 Tubes/50 mL | N9308004 |
| SPB 100-30, (115 V/230 V) | 30 Tubes/100 mL | N9308012 |
| SPB 50-72, (230 V) | 72 Tubes/50 mL | N9308005 |
| SPB 100-42, (230 V) | 42 Tubes/100 mL | N9308014 |

*sold separately.



Controllers

The user friendly SPB Digital Controller includes programmable features such as: temperature set-point to 0.1 °C, even sample heating and evaporation results, timer shutdown option, and programmable alarm for end of cycle.

The SPB Touch Controller includes all of the SPB Digital Controller features and more. Added features include: a graphical representation of the heating profile in real-time to identify the current stage of the method heating program. Safety features include the ability of the controller to monitor the heating cycle of the block to prevent run away situations. The controller allows for the SPB Probe to be calibrated to meet your SOP requirements.

The SPB Probe, used with either the Digital or Touch models, can directly monitor and control the block's heating rate via sample temperature feedback to the controller.

Controllers

| Description | Part No. |
|------------------------|----------|
| SPB Digital Controller | N9308006 |
| SPB Touch Controller | N9308007 |



Start Up Kits

PerkinElmer's SPB Start Up kits contain all consumable items required to operate the system including: RackLock DigiTUBE®s and Caps, disposable Watch Glasses, DigiFILTER™s, RackLock Racks and Storage Racks.

Start Up Kits

| Description | DigiTUBE®s/ Caps | Watch Glasses | Racks | Part No. |
|-----------------------------|---------------------|------------------|-------|-----------------|
| Start Up Kit for SPB 15-40 | 540 | | 2 | N9308704 |
| Start Up Kit for SPB 15-108 | 540 | | 2 | N9308706 |
| Start Up Kit for SPB 50-24 | 500 | 1000 | 1 | N9308017 |
| Start Up Kit for SPB 100-12 | 200 | 500 | 1 | N9308011 |
| Start Up Kit for SPB 50-48 | 500 | 1000 | 2 | N9308002 |
| Start Up Kit for SPB 100-30 | 200 | 500 | 2 | N9308013 |
| Start Up Kit for SPB 50-72 | 500 | 1000 | 3 | N9308025 |
| Start Up Kit for SPB 100-42 | 200 | 500 | 2 | N9308015 |



DigiFILTER™

The vacuum assisted DigiFILTER™ assembly provides a quick and easy way to filter samples prior to analysis. Increase lab productivity by filtering particulates from digested samples in a matter of seconds directly from the digestion tube. Available with a 0.45 or 1.0 micron hydrophilic PTFE membrane. Field Filtration Kit conforms to Item 8.2 in the EPA 200.7, 200.8 and 200.9 Methods.

DigiFILTERs™

| Description | Quantity | Part No. |
|---|----------|-----------------|
| DigiFILTER™ 0.45 micron for 50 mL DigiTUBE®s | 100 | N9308031 |
| DigiFILTER™ 1.0 micron for 50 mL DigiTUBE®s | 100 | N9308032 |
| Field Filtration Kit 0.45 for 50 mL DigiTUBE®s* | 1 | N9308033 |
| DigiFILTER™ Manifold | 1 | N9308034 |

*Contains: 25 DigiFILTER™s, 30 DigiTUBE®s, 1x 6 mL eyedropper bottle to dispense 2 to 3 drops of (1+1) PlasmaPURE® Nitric acid, 1 storage rack, 1 Sharpie® pen and 2x 60 mL plastic syringes to create a vacuum to filter samples from the collection vessel to the sample tube.

Tubes, Caps and Watch Glasses

Why use a thermometer to monitor and manually adjust sample temperature when a SPB Probe will automatically do the job? The SPB Probe provides direct control and monitoring of actual sample temperature via a corrosion-resistant, PFA-coated temperature probe. Available with different holders in a 6" configuration for use with 50 and 100 mL DigiTUBE®s. Each probe is supplied with 5 Probe Watch Glasses and a probe holder.



Tubes, Caps and Watch Glasses

| Description | Quantity | Part No. |
|---|----------|-----------------|
| Tubes | | |
| DigiTUBE®s 15 mL with RackLock (incl. caps) | 1620 | N9308711 |
| DigiTUBE®s 15 mL with RackLock (no caps) | 1620 | N9308712 |
| DigiTUBE®s 15 mL with RackLock (incl. caps) | 540 | N9308713 |
| DigiTUBE®s 50 mL with RackLock (incl. caps) | 750 | N9308008 |
| DigiTUBE®s 50 mL with RackLock (no caps) | 750 | N9308340 |
| DigiTUBE®s 50 mL with non-RackLock (incl. caps) | 750 | N9308037 |
| DigiTUBE®s 100 mL with RackLock (incl. caps) | 300 | N9308016 |
| DigiTUBE®s 100 mL with non-RackLock (incl. caps) | 300 | N9308066 |
| PTFE Digestion Tube 50 mL (incl. blue caps) | 6 | N9308024 |
| Tube, Quartz, 62.5 mL, Uncalibrated | 6 | N9308048 |
| Tube, Borosilicate, 62.5 mL, Uncalibrated | 6 | N9308049 |
| Tube, Borosilicate, 62.5 mL, Calibrated at 50 mL | 6 | N9308050 |
| Caps | | |
| Screw Caps, Blue, for 15 mL DigiTUBE®s | 540 | N9308705 |
| Screw Caps, Clear, for 15 mL DigiTUBE®s | 540 | N9308708 |
| Screw Caps, Orange, for 50 mL DigiTUBE®s | 250 | N9308058 |
| Screw Caps, Red, for 50 mL DigiTUBE®s | 250 | N9308059 |
| Screw Caps, Clear, for 50 mL DigiTUBE®s | 250 | N9308060 |
| Screw Caps, Yellow, for 50 mL DigiTUBE®s | 250 | N9308056 |
| PTFE Screw Cap for PTFE 50 mL, N9308024 replaces blue caps supplied | 6 | N9308027 |
| Watch Glasses | | |
| Disposable Watch Glasses, 50 mL | 1000 | N9308003 |
| Disposable Watch Glasses, 100 mL | 500 | N9308030 |

DigiTUBE® Dimensions

| Tube | Outside | Inside |
|------------------|---------|--------|
| 15 mL DigiTUBE® | 1.2 cm | 1.1 cm |
| 50 mL DigiTUBE® | 30 mm | 28 mm |
| 100 mL DigiTUBE® | 46 mm | 44 mm |



Temperature Probes

Why use a thermometer to monitor and manually adjust sample temperature when a SPB Probe will automatically do the job? The SPB Probe provides direct control and monitoring of actual sample temperature via a corrosion-resistant, PFA-coated temperature probe. Available with different holders in a 6" configuration for use with 50 and 100 mL DigiTUBE®s. Each probe is supplied with 5 Probe Watch Glasses and a probe holder.

Temperature Probes

| Description | Quantity | Part No. |
|--|----------|-----------------|
| SPB Probe 6" for 15 mL Tubes | 1 | N9308707 |
| SPB Probe 6" for 50 mL Tubes | 1 | N9308018 |
| SPB Probe 6" for 100 mL Tubes | 1 | N9308009 |
| SPB Probe Watch Glass (replacement) for 50 mL Tubes | 25 | N9308041 |
| SPB Probe Watch Glass (replacement) for 100 mL Tubes | 25 | N9308073 |
| SPB Probe Holder for DigiTUBES 15 mL | 1 | N9308703 |
| SPB Probe Holder for DigiTUBES 50 mL | 1 | N9308044 |
| SPB Probe Holder for DigiTUBES 100 mL | 1 | N9308045 |



Racks

For busy labs, additional acid resistant, polycarbonate Racks are available for all SPB systems. Exclusive RackLock feature locks DigiTUBE®s in position within the rack allowing for easy, one-handed closure of screw cap.

SPB Block Racks

| Description | Quantity | Part No. |
|---|----------|-----------------|
| 40 Position Rack for SPB 15-40, 15 mL | 1 | N9308700 |
| 54 Position Rack for SPB 15-108, 15 mL | 1 | N9308701 |
| 12 position Rack for SPB-100-12, 100 mL | 1 | N9308067 |
| 15 position Rack for SPB-100-30, 100 mL | 1 | N9308068 |
| 21 position Rack for SPB-100-42, 100 mL | 1 | N9308069 |
| 24 position Rack for SPB-50-24, 50 mL | 1 | N9308070 |
| 24 position Rack for SPB-50-48 and SPB-50-72, 50 mL | 1 | N9308042 |

Storage Racks

| Description | Quantity | Part No. |
|----------------------------|----------|-----------------|
| Foam Storage Rack 15 mL | 5 | N9308702 |
| Plastic Storage Rack 50 mL | 5 | N9308381 |
| Foam Storage Rack 100 mL | 5 | N9308382 |

Automatic Shut-Off System



Designed to shut-off SPB systems with no lab supervision. Ideal for overnight digestions and evaporations where samples require volume reductions (volume control ± 2.5 mL). Increase lab efficiency by automatically digesting samples off-hours. Select appropriate Probe for Tube use.

Controllers

| Description | Quantity | Part No. |
|---------------------------------------|----------|-----------------|
| TempSET, without Probe | 1 | N9308020 |
| TempSET Probe for 50 mL Tubes | 1 | N9308023 |
| TempSET Probe for 100 mL Tubes | 1 | N9308029 |
| TempSET Probe Holder for 100 mL Tubes | 1 | N9308065 |

Fume Hoods and Accessories



The bench top fume hoods for SPB systems are the right choice for trace-metal digestions. Made from clear, acid resistant polycarbonate with a solid surface material base, the fume hood eliminates the risk of trace-metal contamination common with traditional fume hoods. HEPA® filters ensure clean input air. The fume hood can be connected to an in-house laboratory exhaust system or used with the SPB blower unit (N9308022). Fume hoods come flatpacked to save transport costs and can be assembled in minutes without tools.

Fume Hoods and Accessories

| Description | Part No. |
|---|-----------------|
| Fume Hood for SPB 50-24/100-12, 50-48/100-30 | N9308000 |
| Fume Hood for SPB 50-72/100-42 - Filter for SPB Fume Hoods N9308078 | N9308001 |
| Fume Hood II for AutoSampler | N9308036 |
| DigiVAC™ Evacuation Hood, mounts directly on SPB 50-48/SPB 100-30 | N9308021 |
| SPB Blower Unit, for use with all systems | N9308022 |

GREAT RESULTS BEGIN WITH GOOD PREPARATION



Titan MPS™ Microwave Sample Preparation System

PerkinElmer offers the Titan MPS microwave sample preparation systems, consumables and accessories for your lab needs.

Microwave digestion provides the high-temperature, high-pressure digestion needed to deliver quick, complete sample digestion of the most difficult samples and allow for total elemental analysis. Using ultra-clean sealed digestion vessels, the Titan MPS avoids loss of volatile analytes and prevents sample contamination from the working environment. With its high performance, microwave digestion is ideal for nearly any sample including those from the challenging mining/geologic, metallurgical, environmental, petrochemical and pharmaceutical industries.

The Titan MPS microwave sample preparation system delivers the instrument-ready solutions you need for high throughput and reliable results. Using our Direct Pressure Control™ (DPC) and Direct Temperature Control™ (DTC) sensing technologies, the Titan MPS system accurately monitors digestion reactions and the sample temperature in each digestion vessel to provide outstanding reaction control and deliver consistent digestion results.

With the Titan MPS microwave sample preparation system, we're delivering on the promise of a simple, safe, cost-effective microwave – one that provides the quick return on investment that labs are looking for in these times of constrained budgets. And it's backed by PerkinElmer, the one-stop, go-to resource for all things atomic spectroscopy. With a team of support individuals who understand, in a deep-seated way, the science behind the goals your lab is trying to achieve.

The Titan MPS microwave sample preparation system. Yes, it's a microwave. But we think it's a whole lot more.

Features:

- A top-loading system that allows the easy loading and removal of vessels.
- The DTC and DPC optical temperature and pressure reaction monitoring technologies and a cylindrical oven chamber ensure the most reproducible results.
- Vessels are reusable and guaranteed for one year, for considerable savings on consumables.
- Integrated gas collection system efficiently vents the oven chamber to keep it free of gas or acidic vapors.
- Color touch-screen controller simplifies programming, data storage, and reaction control.
- The PFA-coated stainless steel body and lid, safety interlocks and unique vessels deliver the highest level of operator safety and unprecedented corrosion resistance.

Titan MPS Systems

Before you prepare your first sample, you'll notice the difference: The Titan MPS is a top-loading microwave sample preparation system protected by hardware interlocks to ensure safety during operation. And it's simple to load and unload samples, which keeps everyone more productive – and saves your lab time and money.

Titan MPS 16 Position



Includes: 16 position turntable, gas containment manifold, 16 standard pressure 75 mL digestion vessels, 15 vessel caps without pressure sensor, 1 vessel cap with pressure sensor, a lip seal forming tool, exhaust hose, consumables kit, and power cord (US)

Weight: 53 kg

Dimensions (WxDxH): 21 in. x 25 in. x 17 in.

| Description | Part No. |
|---------------------------------------|-----------------|
| Titan MPS 16 Position, (230V 50/60Hz) | N3130100 |

Titan MPS 8 Position



Includes: 8 position turntable, gas containment manifold, 8 high pressure 100 mL digestion vessels, 8 TFM sample vessel inserts, 8 ceramic pressure jackets, 7 Vessel Caps without pressure sensor, 1 vessel cap with pressure sensor, a vessel opening station, a lip seal forming tool, exhaust hose, consumables kit, and power cord (US)

Weight: 53 kg

Dimensions (WxDxH): 21 in. x 25 in. x 17 in.

| Description | Part No. |
|--------------------------------------|-----------------|
| Titan MPS 8 Position, (230V 50/60Hz) | N3130110 |

System Accessories



External Exhaust System

Optional accessory for exhausting Titan MPS oven cavity in laboratories that do not have exhaust systems.

Includes: one 1.5 m exhaust tube. ID = 76 mm, OD = 82 mm. and power cord (US)

| Description | Part No. |
|---------------------------------------|-----------------|
| External Exhaust System 230V 50/60 Hz | N3131009 |

Exhaust Tubes



| Description | Part No. |
|---|-----------------|
| Exhaust Tube 1.5 m (one included with Titan) | N3134015 |
| Exhaust Tube 3 m (optional if longer is required) | N3134064 |

Titan MPS Bench



The Titan MPS bench is a heavy-duty Chemsurf laminated rolling cart. The top working surface is constructed with durable Chemsurf material, a chemically-resistant laminate specifically designed for applications in laboratories with routine exposure to chemicals. A full lower shelf with durable Chemsurf laminate provides storage space for digestion vessels and other Titan MPS spares and accessories. Locking 4" diameter casters provide stability and easy movement.

Dimensions: 32"D x 30"W x 29"H

| Description | Part No. |
|-----------------|-----------------|
| Titan MPS Bench | N0777900 |



Turntables

| Description | Part No. |
|--|-----------------|
| 16 Position | |
| 16 position turntable with Standard 75 mL (40 Bar) Digestion Vessels, with DPC (complete) | N3131010 |
| 16 position turntable with Standard 75 mL (40 Bar) Digestion Vessels, without DPC (complete) | N3131005 |
| 16 position turntable for Standard 75 mL (40 Bar) Digestion Vessels (turntable only) | N3131006 |
| 8 Position | |
| 8 position turntable with High Pressure 100 mL (100 Bar) Digestion Vessels, with DPC (complete) | N3131011 |
| 8 position turntable with High Pressure 100 mL (100 Bar) Digestion Vessels, without DPC (complete) | N3131007 |
| 8 position turntable for High Pressure 100 mL (100 Bar) Digestion Vessels (turntable only) | N3131008 |



Vessels and Spares

| Description | Part No. |
|---|-----------------|
| Standard (All Part No. Quantities are 1) | |
| Standard 75 mL (40 Bar) Digestion Vessel without DPC Consists of: Pressure seal, Vessel cap, Rupture disc and Vessel base | N3132009 |
| Standard 75 mL (40 Bar) Digestion Vessel with DPC (Complete) Consists of: Pressure seal, Vessel cap with DPC, Rupture disc and Vessel base | N3132010 |
| Standard 75 mL (40 Bar) Digestion Vessel TFM Base (base only) | N3132011 |
| TFM Cap for Standard 75 mL (40 Bar) Digestion vessels without pressure sensor | N3132012 |
| TFM DPC Cap for Standard 75 mL (40 Bar) Digestion vessels with pressure sensor | N3132013 |
| High Pressure (All Part No. Quantities are 1) | |
| High Pressure 100 mL (100 Bar) Digestion Vessel without DPC (complete) Consists of: Pressure seal, Vessel cap, Rupture disc, TFM Vessel insert, Ceramic pressure jacket and Vessel base | N3133012 |
| High Pressure 100 mL (100 Bar) Digestion Vessel with DPC (complete) Consists of: Pressure seal, Closure cap with DPC, Rupture disc, TFM Vessel insert, Ceramic pressure jacket and Vessel base | N3133013 |
| High Pressure 100 mL (100 Bar) Digestion Vessel Base (base only) | N3133014 |
| TFM Cap for High Pressure 100 mL (100 Bar) Digestion Vessels without pressure sensor | N3133015 |
| TFM DPC for high pressure 100 mL (100 Bar) Digestion Vessels with pressure sensor | N3133016 |



Consumable Kits

| Description | Part No. |
|--|-----------------|
| Consumable Kit for Standard 75 mL Digestion Vessels | |
| Consumable Kit for Standard 75 mL (40 Bar) Digestion Vessels | N3132000 |

Includes: 10 Pressure Seals (N3132002), 4 Rupture Cap Discs (N3132001), and 5 Lip Seal Rings of the Gas Containment Manifold (N3134000)

| Description | Part No. |
|---|-----------------|
| Consumable Kit for High Pressure 100 mL Digestion Vessels | |
| Consumable Kit for High Pressure 100 mL (100 Bar) Digestion Vessels | N3133024 |

Includes: 10 Pressure Seals (N31330203), 7 Rupture Cap Discs (N3133022), 50 PEEK Ring Nuts (N3133011), and 5 Lip Seal Rings of the Gas Containment Manifold (N3134000)



Spares and Replacement Parts

| Description | Part No. |
|--|-----------------|
| Rupture Disc for Standard 75 mL (40 Bar) Digestion Vessels Made of aluminum, set of 25 pcs | N3132001 |
| Pressure Seal for Standard 75 mL (40 Bar) Digestion Vessels Made of TFM, set of 10 pcs | N3132002 |
| DPC Glass-Ring for Standard 75 mL (40 Bar) Digestion Vessel | N3132003 |
| DPC Glass Prism for Standard 75 mL (40 Bar) Digestion Vessel | N3132004 |
| DPC Polarization foil for Digestion Vessel caps with pressure control for Standard 75 mL (40 Bar) and High Pressure 100 mL (100 Bar) Digestion Vessel, set of 24 pcs | N3132005 |
| DPC TFM Cap Insert for Standard 75 mL (40 Bar) Digestion Vessel | N3132006 |
| DPC Clamp Screw for Glass Prism for Standard 75 mL (40 Bar) Digestion Vessel | N3132007 |
| DPC Viton O-Ring (25 x 3 mm) for Digestion Vessel caps with pressure control for Standard 75 mL (40 Bar) Digestion Vessel, qty 1. Two are required per vessel cap | N3132008 |
| Rupture Disc for High Pressure 100 mL (100 Bar) Digestion Vessels Made of titanium, set of 10 pcs | N3133022 |
| Pressure Seal for High Pressure 100 mL (100 Bar) Digestion Vessels Made of TFM, set of 5 pcs | N3133023 |
| DPC Glass-Ring for High Pressure 100 mL (100 Bar) Digestion Vessel | N3133003 |
| DPC Glass Prism for High Pressure 100 mL (100 Bar) Digestion Vessel | N3132004 |
| DPC TFM Cap Insert for High Pressure 100 mL (100 Bar) Digestion Vessel | N3133006 |
| DPC Clamp Screw for Glass Prism for High Pressure 100 mL (100 Bar) Digestion Vessel | N3133007 |
| DPC O-Ring for Digestion Vessel Caps with pressure control for High Pressure 100 mL (100 Bar) Digestion Vessel, qty 1. Two are required per vessel cap | N3133008 |
| DPC Polarization foil for Digestion Vessel caps with pressure control for Standard 75 mL (40 Bar) and High Pressure 100 mL (100 Bar) Digestion Vessel, set of 24 pcs | N3132005 |



| | |
|---|-----------------|
| TFM Sample Vessel Insert for High Pressure 100 mL (100 Bar) Digestion Vessel | N3133009 |
| Ceramic Pressure Jacket for High Pressure 100 mL (100 Bar) Digestion Vessel | N3133010 |
| PEEK Ring Nut for High Pressure 100 mL (100 Bar) Digestion Vessel closure cap. (Left handed threads) | N3133011 |
| PEEK Ring Nut Removal Tool for 100 mL | N3133021 |



Gas Containment Manifold Spares

| Description | Part No. |
|--|-----------------|
| End Cap Plug for Gas Containment Manifold Sealing plug for 8 and 16 position Gas Containment Manifold to seal the gas collection system at unused vessel positions | N3134004 |
| Clamping Screw (PTFE) for the top seal of the 8 and 16 position Gas Containment Manifold | N3134002 |
| Lip Seal Ring of the Gas Containment Manifold PTFE Sealing Ring for use with 8 and 16 position Gas Containment Manifolds Seals the top PFA gas tube to the Gas Containment Manifold | N3134000 |
| Tube for connection of vessel to Gas Containment Manifold (PTFE) PTFE connecting tube for connection to digestion vessels with 8 and 16 position Gas Containment Manifold | N3134005 |
| PTFE connector for use with 8 and 16 position Gas Containment Manifold | N3134007 |
| Gas Containment Manifold PFA Vent Line 1M (O-Ring in picture not included) | N3134014 |
| Gas Containment Manifold Vent Line replacement O-Ring (Qty. 2) | N3134072 |



Accessories

| Description | Part No. |
|---|-----------------|
| Single lip seal forming tool for Standard 75 mL (40 Bar) Digestion Vessel pressure seals | N3132015 |
| Eight position lip seal forming tool for Standard 75 mL (40 Bar) Digestion Vessel pressure seals Forms up to 8 seals simultaneously | N3132014 |
| Vessel cap disassembly tools for Standard 75 mL (40 Bar) Digestion Vessel | N3134011 |
| High Pressure 100 mL (100 Bar) Digestion Vessel opening station | N3133017 |
| Eight position lip seal forming tool for High Pressure 100 mL (100 Bar) Digestion Vessel pressure seals | N3133018 |
| Single lip seal forming tool for High Pressure 100 mL (100 Bar) Digestion Vessel pressure seals Forms 1 seal | N3133019 |
| Vessel cap disassembly tools for High Pressure 100 mL (100 Bar) Digestion Vessel | N3134012 |
| PTFE 2 mL sample weighing cup for use in Standard 75 mL (40 Bar) or High Pressure 100 mL (100 Bar) Digestion Vessel, qty. 1 | N3134009 |
| PTFE 2 mL sample weighing cup for use in Standard 75 mL (40 Bar) or High Pressure 100 mL (100 Bar) Digestion Vessel, qty. 16 | N3134010 |
| Turntable Base Ring | N3134013 |

HUMAN HEALTH

ENVIRONMENTAL HEALTH



LEAPFROGGING EVERYONE IN SENSITIVITY AND STABILITY



CLARUS SQ 8 GC/MS

Experience world-leading performance with the new Clarus® SQ 8 GC/MS.

Engineered around the industry's most sensitive, long-lasting Clarifi™ detector and a unique SMARTsource™, the revolutionary Clarus SQ 8 has leapt to the front of the pack in GC/MS. No other instrument comes close to its detection limits, mass range or long-term stability. Nothing delivers greater confidence in your results, or greater productivity in your lab. Visit www.perkinelmer.com/ClarusGCMS. And take a giant leap forward with the Clarus SQ 8.

www.perkinelmer.com/ClarusGCMS

PerkinElmer®
For the Better



CHROMATOGRAPHY

PerkinElmer has been a leading provider of Chromatography solutions for over 50 years. Our team of dedicated Chromatography Specialists has an expertise that boasts years of knowledge in understanding a laboratory's product requirements. This knowledge allows us to give you a focused consumables portfolio to fit your applications. From colored inlet liners that help you easily identify the correct liner for your application to gas purification systems that remove up to 99.99% of contaminants, our precision-designed, genuine tested and approved consumables will provide you with solid, reliable support, giving you all you need to succeed. But our solutions don't stop there.

At PerkinElmer, we're committed to providing you with the best selection of solutions for all your Chromatography needs, regardless of make, model or manufacturer. We have invested heavily in growing our portfolio, at your request, to bring you the best performing and productivity enhancing consumables and accessories for all your gas chromatograph systems.

Sample Preparation

| | |
|-------------------------------------|---------|
| Crimping Tools and Vial Accessories | 121 |
| QuEChERS Dispersive SPE | 110-111 |
| Solid Phase Extraction (SPE) | 101-109 |
| Syringes | 112 |
| Syringe Filters | 100 |
| Vials, Caps and Septa | 113-120 |

Our consumables can be depended upon to meet the most demanding performance and throughput needs for today's analytical, process monitoring and quality control facilities.

Liquid Chromatography

| | |
|-------------------------------------|---------|
| Autosamplers and Accessories | 164-165 |
| Columns - Cartridge | 144-153 |
| Columns - Cartridge Holders | 153 |
| Columns - Conventional | 127-141 |
| Columns- Conventional Guard Columns | 142-143 |
| Columns - SPP | 124-126 |
| Detector Lamps | 155 |
| Fittings | 162 |
| Flexar Consumables and Accessories | 122-123 |
| Flexar Supplies and Accessories | 166-168 |
| Flow Cells and Pump Accessory Kits | 154 |
| Injection Valves and Rotor Seals | 163 |
| Nitrogen Generators | 169-171 |
| Pumps | 158-160 |
| Sample Loops and Tubing | 161 |
| Vacuum Degassing Kits | 156-157 |

Gas Chromatography

| | |
|--|-----------|
| Autosampler Parts and Accessories | 228 |
| Capillary Columns | 172 - 196 |
| Capillary Columns - Arnel Analyzers | 198 |
| Capillary Columns - Cross Reference | 174-175 |
| Capillary Columns - General Purpose | 176-188 |
| Capillary Columns - Specialty Phase | 189-195 |
| Calibration Gas Blends - Arnel Analyzers | 199 |
| Custom Packed Columns | 197 |
| Detectors | 214-220 |
| Ferrules and Connectors | 200 |
| Fittings | 201 |
| Gas Management - Compressors | 240 |
| Gas Management - Filters | 229-233 |
| Gas Management - Flow Meters | 243 |
| Gas Management - Hydrogen Generators | 234-237 |
| Gas Management - Leak Detectors | 242 |
| Gas Management - Regulators | 241 |
| Gas Management - Zero Air Generators | 238-239 |
| Injection Port Septum | 213 |
| Injectors | 204-209 |
| Liners | 210-211 |
| Marathon Filament | 221 |
| Organic Standards | 244-245 |
| SMARTSource | 222-223 |
| Swafer | 202-203 |
| Syringes | 212 |
| Thermal Desorber Consumables | 224-227 |

TESTED AND APPROVED



Syringe Filters

Our Syringe Filters are lab tested and certified to bring you the highest quality syringe filters available. Our membrane materials are supplied per ISO9001:2008 certified manufacturing practices, in certified clean room conditions, using the latest manufacturing technology to ensure you receive a high quality, consistent product every time.

Our superior premium 17 and 30 mm filters are suitable for coarse/crude samples or higher detection limit applications (such as food, beverage, or environmental analysis). Our 4, 13 and 25 mm syringe filters are ideal for routine QA/QC analysis

Nylon Syringe Filters

Ideal for aqueous (non-acidic) or organic sample preparation and HPLC, GC or dissolution sample analysis. With its excellent flow characteristics, very low extractable levels and mechanical stability, Nylon offers the best combination of physical parameters to meet the most stringent analytical needs.

| Size | Pack Size | Color | 0.22 µm Particle Part No. | 0.45 µm Particle Part No. |
|-------|-----------|--------|---------------------------|---------------------------|
| 4 mm | 200 | Clear | 02542900 | 02542901 |
| 13 mm | 100 | Purple | 02542902 | 02542903 |
| 17 mm | 100 | Yellow | 02542881 | 02542880 |
| 25 mm | 100 | Purple | 02542904 | 02542905 |
| 30 mm | 100 | Yellow | 02542883 | 02542882 |

PTFE (Hydrophobic) Syringe Filters

Versatile filters for use with aggressive organic solvent-based solutions and are especially ideal for HPLC sample preparation. Hydrophobic PTFE syringe filters have broad chemical compatibility and high pH resistance.

| Size | Pack Size | Color | 0.22 µm Particle Part No. | 0.45 µm Particle Part No. |
|-------|-----------|-------|---------------------------|---------------------------|
| 4 mm | 200 | Clear | 02542906 | 02542907 |
| 13 mm | 100 | Red | 02542908 | 02542909 |
| 17 mm | 100 | Red | 02542884 | 02542910 |
| 25 mm | 100 | Red | 02542911 | 02542912 |
| 30 mm | 100 | Red | 02542886 | 02542885 |

PVDF (Hydrophobic Polyvinylidene Fluoride) Syringe Filters

Ideal for a wide range of mild organic solutions. PVDF membranes are not recommended for use with acetone, DMF, DMSO, or bases >6N.

| Size | Pack Size | Color | 0.22 µm Particle Part No. | 0.45 µm Particle Part No. |
|-------|-----------|--------|---------------------------|---------------------------|
| 4 mm | 200 | Clear | 02542913 | 02542914 |
| 13 mm | 100 | Yellow | 02542915 | 02542783 |
| 17 mm | 100 | Maroon | 02542916 | 02542917 |
| 25 mm | 100 | Yellow | 02542918 | 02542919 |
| 30 mm | 100 | Maroon | 02542920 | 02542921 |

PTFE (Hydrophilic) Syringe Filters

Versatile filters for use with aqueous and aggressive organic solvent-based solutions and are especially ideal for HPLC sample preparation. They have broad chemical compatibility and high pH resistance.

| Size | Pack Size | Color | 0.22 µm Particle Part No. | 0.45 µm Particle Part No. |
|-------|-----------|-------|---------------------------|---------------------------|
| 4 mm | 200 | Clear | 02542922 | 02542923 |
| 13 mm | 100 | Red | 02542924 | 02542925 |
| 25 mm | 100 | Red | 02542926 | 02542927 |
| 30 mm | 100 | Red | 02542928 | 02542929 |

SUPERIOR REPRODUCIBILITY SUPERIOR RESULTS



Supra-Clean and Supra-Poly SPE Solutions

Manufactured for guaranteed reproducibility and superior performance, this innovative line of SPE solutions includes the Supra-Clean® silica based and Supra-Poly® polymer based line of spherical media SPE cartridges and columns.

Both utilize Precise Bed Technology® allowing columns to be evenly and consistently filled with particles sized for optimum distribution. This homogeneous filling yields a +/- 1% variation in bed volume precision, ensuring you experience repeatability and optimized recovery reproducibility.

Ideal for a broad array of analytes and matrices, SPE solutions are available in a variety of formats including Large Reservoir Capacity (LRC) columns, Polypropylene (PP) columns and cartridges, and glass columns. Each technology is offered with a wide selection of polymer and silica sorbents, and large and small sample volumes (50µL-1L) allow you to perform scalable analyses depending upon your required detection limits.

Each finished product is delivered with an individual quality certificate.

SPE Manifolds, Selection Kits and Application Packs

For greater method development simplicity and sample throughput, PerkinElmer offers a variety of pre-prepared column selection kits as well as application kits for you to choose from.

SPE Manifolds:

- Allow you to process up to 24 samples simultaneously
- Seamlessly integrate with columns to extend the system's performance and reproducibility
- Feature polypropylene or stainless steel needle valves and tips with minimum dead volume
- Rugged stopcocks are reusable and provide independent flow control

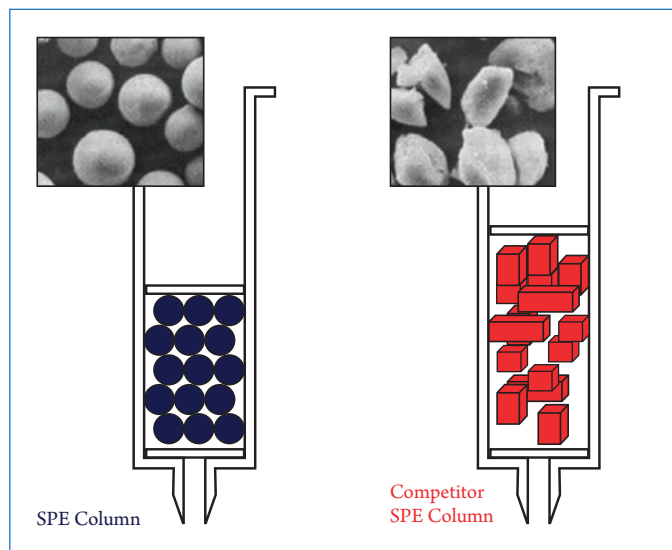

Spherical media and consistent particle distribution enable smaller elution volumes and better, more reproducible extraction, purification, concentration and recovery.

Performance Comparison of PerkinElmer Spherical SPE Media vs. Leading Irregular SPE Silica.

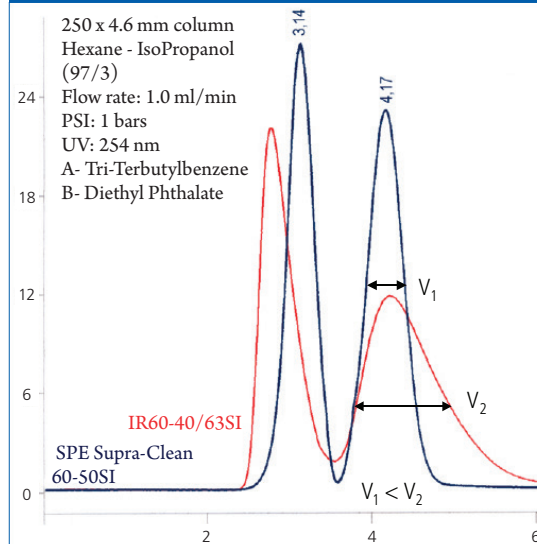

PerkinElmer's smaller, more homogeneous, spherical media deliver sharper, narrower peaks for faster, more accurate sample analysis.

A WIDE ARRAY OF COLUMNS FOR A BROAD RANGE OF APPLICATIONS

| SUPRA-CLEAN SPHERICAL SILICA | | | | |
|----------------------------------|---------------------------------|----------------------|---|---|
| Phase | Mechanism | Interaction mode | Compounds | Matrix |
| C18-S | Hydrophobic | Reversed Phase | Polar to Non-Polar compounds | Biological fluids, aqueous samples |
| High Recovery REC18 | Hydrophobic | Reversed Phase | Non-polar and mid-polar compounds including 100% water solvents | Biological fluids, aqueous samples toxins in food |
| Phenyl (PH-S) | Hydrophobic | Reversed Phase | Non-polar to mid-polar aromatic compounds | Biological fluids |
| Silica (SI-S) | Hydrophilic | Normal Phase | Polar compounds | Non-polar organics, oils, lipids |
| Amino (NH2-S) | Hydrophilic | Normal Phase | Polar to Mid-Polar aromatic compounds | Biological fluids, aqueous samples, buffered organics |
| Strong Cation Exchange (SCX) | Ion Exchange | Ion Exchange | Basic compounds | Biological fluids, aqueous samples, buffered organics |
| Weak cation Exchange (WCX) | Ion Exchange | Ion Exchange | Strong basic compounds | Biological fluids, aqueous samples |
| Strong Anion Exchange (SAX) | Ion Exchange | Ion Exchange | Acidic compounds | Biological fluids, aqueous samples |
| Cyano (CN-S) | Hydrophilic | Normal Phase | Polar to Mid-Polar compounds | Non-polar organics, oils, lipids |
| Florisil (FL-S) | Hydrophilic | Normal Phase | Polar compounds | Ideal for polar compounds in non-polar matrix |
| Florisil Pesticide (FL-S) | Hydrophilic | Normal Phase | Polar compounds | Ideal for polar compounds in non-polar matrix |
| Polyamine (P6) | Hydrophilic | Reversed Phase | Carboxylic acids, phenolics and nitroaromatics | Aqueous and mid-polar matrices |
| 300 A (C4) | Hydrophobic | Reversed Phase | Non-polar to mid-polar compounds | Biological Samples |
| LCC | Hydrophobic | Reversed Phase | Non-polar to mid-polar compounds | Biological fluids, aqueous samples |
| Mixed mode (MM1) | Ion Exchange/ Hydrophobic | Reversed Phase / SCX | Basic compounds | Biological samples |
| Mixed mode (MM2) | Ion Exchange/ Hydrophobic | Reversed Phase / WCX | Very basic compounds | Biological samples |
| Mixed mode (MM3) | Ion Exchange/ Hydrophobic | Reversed Phase / SAX | Acidic compounds | Biological samples |
| SUPRA-POLY SPHERICAL POLYMER | | | | |
| Extreme Capacity (XC) | Hydrophobic | Reversed Phase | Polar and non-polar | Aqueous or organic |
| Extreme Capacity Wide Pore (XWP) | Hydrophobic | Reversed Phase | Polar and non-polar | Biological and viscous samples |
| Hydrophilic (ATH) | Hydrophilic | Reversed Phase | Mid to non-polar compounds | Aqueous or organic |
| Lipophilic (ATL) | Lipophilic | Reversed Phase | Mid to non-polar compounds | Crude samples |
| Environmental (AEV) | Hydrophilic/ Hydrophobic | Reversed Phase | Mid to non-polar compounds | Aqueous or Organic |
| HLB | Hydrophilic/lipophilic balanced | Reversed Phase | Mid to non-polar compounds | Aqueous or organic |



| Typical Applications | pH Range | End-capping | Pore Size (Å) | Surface Area (m ² /g) | Particle Size (µm) | Comments |
|--|----------|-------------|---------------|----------------------------------|--------------------|---|
| Drugs and drug metabolites in biological matrices, trace organic material in water, toxins in food | 2-8 | Yes | 60 | 500 | 50 | 18% Carbon Load (CL) |
| Drugs and drug metabolites in biological matrices, trace organic material in water, | 2-8 | Yes | NA | NA | 50 | High capacity and better recovery especially for high aqueous conditions. 15% CL |
| Benzodiazepines in biological matrices, extraction of aromatic compounds | 2-8 | No | 60 | 500 | 50 | 9% CL |
| Aldehydes, amines, pesticides, herbicides, carotenoids, fat soluble vitamins, aflatoxins, fatty acids, and phospholipids | 2-8 | No | 60 | 500 | 50 | Bare Silica |
| Basic compounds, polar amine compounds, carbohydrates | 2-8 | No | 60 | 500 | 50 | 5% CL |
| Cations, antibiotics, drugs, amino acids, catecholamines, herbicides, nucleic acid bases, nucleosides, and surfactants | 2-8 | No | 60 | 450 | 60 | Strong Acid - Sulfonic acid; Exchange capacity 0.70 meq/g |
| Cations, amines, antibiotics, drugs, amino acids, catecholamines, nucleic acid bases, nucleosides, and surfactants | 2-8 | No | 60 | 450 | 60 | Weak Acid - Carboxylic acid; Exchange capacity 0.22 meq/g |
| Acidic food pigments, organic acids, phenol compounds, nucleic acids, nucleotides, surfactants | 2-8 | No | 60 | 450 | 60 | Strong Base - quaternary amine; Exchange capacity 0.30 meq/g |
| Polar compounds in hexane and oil | 2-8 | Yes | 60 | 500 | 50 | 8% CL; Mid-range polarity between silica and C18 |
| Pesticides, Polychlorinated Biphenyls (PCB) | 2-8 | No | NA | NA | 200 | Standard grade. Alternative to silica for viscous matrices due to large particle size. |
| Pesticides | 2-8 | No | NA | NA | 200 | High purity pesticide grade. Alternative to silica for viscous matrices |
| Aromatic and natural products; Flavones, Chalkones, Anthraquinones | 2-8 | No | NA | NA | 100 | Nylon 6 |
| Hydrophobic peptides and polypeptides | 2-8 | No | 300 | - | - | Large pore size for isolation of large biomolecules |
| Non-polar compounds in aqueous solution | 2-8 | Yes | 60 | 500 | 50 | 10% CL; Lower carbon load than C18-S and REC18 |
| Drugs and drug metabolites | 2-8 | No | 60 | 450 | 60 | Exchange capacity 0.09 meq/g |
| Drugs and drug metabolites | 2-8 | No | 60 | 450 | 60 | Exchange capacity 0.10 meq/g |
| Drugs and drug metabolites | 2-8 | No | 60 | 450 | 60 | Exchange capacity 0.14 meq/g |
| Drugs and drug metabolites biological fluids | 0-14 | No | NA | 1500 | 70 | High capacity polystyrene-divinylbenzene (PSDVB) |
| Drugs and drug metabolites biological fluids | 0-14 | No | Wide Pore | 1200 | 90 | High capacity PSDVB for large biomolecules and viscous matrices |
| Mid-polar and non-polar compounds in aqueous and organic solvents | 1-13 | No | 70 | 800 | 75 | Mixed hydrophilic/hydrophobic interactions |
| Lipids | 0-14 | No | 70 | 800 | 100 | PSDVB; Alternative to high flow silica for mid-polar to non-polar compounds (<3000D) in crude samples |
| Aqueous environmental compounds that are not retained on C18 | 1-12 | No | 70 | 800 | 75 | Advanced environmental; Polystyrene-co-2-hydroxyethyl methacrylate (PSHEMA) |
| Mid-polar and non-polar compounds in aqueous and organic solvents | 0-14 | No | 80 | 850 | 30 & 60 | Hydrophilic-lipophilic-balanced reversed-phase sorbent for acids, bases and neutrals |

SOLID PHASE EXTRACTION (SPE)



Supra-Clean Columns, Cartridges and 96 Well Plates:

- Pure spherical silica
- Pore size 60 - 120 Å
- 20 chemistries with pH range 2-8

Supra-Clean C18

Columns

| Media Weight | Volume | Quantity | Part No. |
|--------------|--------|----------|----------|
| 50 mg | 1 ml | 50 | N9306476 |
| 100 mg | 1 ml | 100 | N9306478 |
| 100 mg | 3 ml | 50 | N9306523 |
| 200 mg | 3 ml | 50 | N9306462 |
| 500 mg | 3 ml | 50 | N9306438 |
| 500 mg | 3 ml* | 50 | N9306642 |
| 200 mg | 6 ml | 30 | N9306634 |
| 500 mg | 6 ml | 30 | N9306448 |
| 500 mg | 6 ml* | 30 | N9306640 |
| 1 g | 6 ml | 30 | N9306422 |
| 2 g | 6 ml | 30 | N9306430 |
| 2 g | 15 ml | 20 | N9306479 |
| 2 g | 25 ml | 20 | N9306475 |

* Not end-capped

96 Well Plates

| Media Weight | Volume | Quantity | Part No. |
|--------------|--------|----------|----------|
| 25 mg | 2 ml | 1 | N9306566 |
| 50 mg | 2 ml | 1 | N9306567 |
| 100 mg | 2 ml | 1 | N9306568 |

Cartridges

| Media Weight | Volume | Quantity | Part No. |
|--------------|--------|----------|----------|
| 390 mg | | 50 | N9306587 |
| 910 mg | | 50 | N9306588 |
| 1690 mg | | 50 | N9306589 |

Supra-Clean REC18

Columns

| Media Weight | Volume | Quantity | Part No. |
|--------------|--------|----------|----------|
| 50 mg | 1 ml | 50 | N9306519 |
| 100 mg | 1 ml | 100 | N9306520 |
| 100 mg | 3 ml | 50 | N9306455 |
| 200 mg | 3 ml | 50 | N9306521 |
| 500 mg | 3 ml | 50 | N9306522 |
| 200 mg | 6 ml | 30 | N9306633 |
| 500 mg | 6 ml | 30 | N9306457 |
| 1 g | 6 ml | 30 | N9306491 |

96 Well Plates

| Media Weight | Volume | Quantity | Part No. |
|--------------|--------|----------|----------|
| 25 mg | 2 ml | 1 | N9306563 |
| 50 mg | 2 ml | 1 | N9306564 |
| 100 mg | 2 ml | 1 | N9306565 |

Supra-Clean Strong Anion Exchange (SAX)

Columns

| Media Weight | Volume | Quantity | Part No. |
|--------------|--------|----------|----------|
| 50 mg | 1 ml | 50 | N9306553 |
| 100 mg | 1 ml | 100 | N9306471 |
| 100 mg | 3 ml | 50 | N9306554 |
| 200 mg | 3 ml | 50 | N9306482 |
| 500 mg | 3 ml | 50 | N9306555 |
| 500 mg | 6 ml | 30 | N9306556 |

96 Well Plates

| Media Weight | Volume | Quantity | Part No. |
|--------------|--------|----------|----------|
| 25 mg | 2 ml | 1 | N9306581 |
| 50 mg | 2 ml | 1 | N9306582 |
| 100 mg | 2 ml | 1 | N9306583 |

Supra-Clean 300Å C4

Columns

| Media Weight | Volume | Quantity | Part No. |
|--------------|--------|----------|----------|
| 50 mg | 1 ml | 50 | N9306590 |
| 100 mg | 1 ml | 100 | N9306591 |
| 100 mg | 3 ml | 50 | N9306592 |
| 200 mg | 3 ml | 50 | N9306593 |

Supra-Clean Strong Cation Exchange (SCX)

Columns

| Media Weight | Volume | Quantity | Part No. |
|--------------|--------|----------|----------|
| 50 mg | 1 ml | 50 | N9306536 |
| 100 mg | 1 ml | 100 | N9306432 |
| 100 mg | 3 ml | 50 | N9306537 |
| 200 mg | 3 ml | 50 | N9306538 |
| 500 mg | 3 ml | 50 | N9306539 |
| 500 mg | 6 ml | 30 | N9306540 |

96 Well Plates

| Media Weight | Volume | Quantity | Part No. |
|--------------|--------|----------|----------|
| 25 mg | 2 ml | 1 | N9306575 |
| 50 mg | 2 ml | 1 | N9306576 |
| 100 mg | 2 ml | 1 | N9306577 |

Supra-Clean Weak Cation Exchange (WCX)

Columns

| Media Weight | Volume | Quantity | Part No. |
|--------------|--------|----------|----------|
| 50 mg | 1 ml | 50 | N9306544 |
| 100 mg | 1 ml | 100 | N9306545 |
| 100 mg | 3 ml | 50 | N9306546 |
| 200 mg | 3 ml | 50 | N9306547 |
| 500 mg | 3 ml | 50 | N9306420 |
| 500 mg | 6 ml | 30 | N9306407 |

Supra-Clean Mixed-Mode (MM1)

Columns

| Media Weight | Volume | Quantity | Part No. |
|--------------|--------|----------|----------|
| 50 mg | 1 ml | 50 | N9306541 |
| 100 mg | 1 ml | 100 | N9306542 |
| 100 mg | 3 ml | 50 | N9306419 |
| 200 mg | 3 ml | 50 | N9306543 |
| 500 mg | 3 ml | 50 | N9306481 |
| 500 mg | 6 ml | 30 | N9306416 |
| 200 mg | 15 ml | 50 | N9306713 |

96 Well Plates

| Media Weight | Volume | Quantity | Part No. |
|--------------|--------|----------|----------|
| 25 mg | 2 ml | 1 | N9306578 |
| 50 mg | 2 ml | 1 | N9306579 |
| 100 mg | 2 ml | 1 | N9306580 |

Supra-Clean Mixed-Mode (MM2)

Columns

| Media Weight | Volume | Quantity | Part No. |
|--------------|--------|----------|----------|
| 50 mg | 1 ml | 50 | N9306548 |
| 100 mg | 1 ml | 100 | N9306549 |
| 100 mg | 3 ml | 50 | N9306550 |
| 200 mg | 3 ml | 50 | N9306551 |
| 500 mg | 3 ml | 50 | N9306411 |
| 500 mg | 6 ml | 30 | N9306552 |

Supra-Clean Mixed-Mode (MM3)

Columns

| Media Weight | Volume | Quantity | Part No. |
|--------------|--------|----------|----------|
| 500 mg | 6 ml | 30 | N9306649 |

Supra-Clean Florisil (FL-S)

Columns

| Media Weight | Volume | Quantity | Part No. |
|--------------|--------|----------|----------|
| 200 mg | 3 ml | 50 | N9306511 |
| 500 mg | 3 ml | 50 | N9306512 |
| 500 mg | 6 ml | 30 | N9306494 |
| 1 g | 6 ml | 30 | N9306413 |
| 2 g | 6 ml | 20 | N9306513 |
| 2 g | 15 ml | 20 | N9306514 |
| 2 g | 25 ml | 20 | N9306515 |

Supra-Clean Florisil (FL-S) Pesticide Grade

Columns

| Media Weight | Volume | Quantity | Part No. |
|--------------|--------|----------|----------|
| 200 mg | 3 ml | 50 | N9306516 |
| 500 mg | 3 ml | 50 | N9306400 |
| 500 mg | 6 ml | 30 | N9306517 |
| 1 g | 6 ml | 30 | N9306436 |
| 2 g | 6 ml | 30 | N9306470 |
| 2 g | 15 ml | 20 | N9306443 |
| 2 g | 25 ml | 20 | N9306447 |

SOLID PHASE EXTRACTION (SPE)

Supra-Clean Silica (SI-S)

Columns

| Media Weight | Volume | Quantity | Part No. |
|--------------|--------|----------|----------|
| 100 mg | 3 ml | 50 | N9306532 |
| 200 mg | 3 ml | 50 | N9306444 |
| 500 mg | 3 ml | 50 | N9306402 |
| 500 mg | 6 ml | 30 | N9306466 |
| 1 g | 6 ml | 30 | N9306404 |
| 2 g | 6 ml | 20 | N9306533 |
| 2 g | 15 ml | 20 | N9306534 |
| 2 g | 25 ml | 20 | N9306535 |

Cartridges

| Media Weight | Volume | Quantity | Part No. |
|--------------|--------|----------|----------|
| 300 mg | | 50 | N9306584 |
| 700 mg | | 50 | N9306585 |
| 1300 mg | | 50 | N9306586 |

Supra-Clean Cyano (CN-S)

Columns

| Media Weight | Volume | Quantity | Part No. |
|--------------|--------|----------|----------|
| 500 mg | 3 ml | 50 | N9306645 |
| 500 mg | 6 ml | 30 | N9306644 |

Supra-Clean Amino (NH2-S)

Columns

| Media Weight | Volume | Quantity | Part No. |
|--------------|--------|----------|----------|
| 50 mg | 1 ml | 50 | N9306528 |
| 100 mg | 1 ml | 100 | N9306410 |
| 100 mg | 3 ml | 50 | N9306529 |
| 500 mg | 3 ml | 50 | N9306414 |
| 200 mg | 6 ml | 50 | N9306530 |
| 500 mg | 6 ml | 30 | N9306531 |

96 Well Plates

| Media Weight | Volume | Quantity | Part No. |
|--------------|--------|----------|----------|
| 25 mg | 2 ml | 1 | N9306572 |
| 50 mg | 2 ml | 1 | N9306573 |
| 100 mg | 2 ml | 1 | N9306574 |

Supra-Clean Polyamine (P6)

Columns

| Media Weight | Volume | Quantity | Part No. |
|--------------|--------|----------|----------|
| 500 mg | 3 ml | 50 | N9306518 |
| 500 mg | 6 ml | 30 | N9306434 |

Supra-Clean Phenyl (PH-S)

Columns

| Media Weight | Volume | Quantity | Part No. |
|--------------|--------|----------|----------|
| 50 mg | 1 ml | 50 | N9306401 |
| 100 mg | 1 ml | 100 | N9306524 |
| 100 mg | 3 ml | 50 | N9306525 |
| 200 mg | 3 ml | 50 | N9306490 |
| 500 mg | 3 ml | 50 | N9306421 |
| 500 mg | 6 ml | 30 | N9306526 |
| 1 g | 6 ml | 30 | N9306527 |

96 Well Plates

| Media Weight | Volume | Quantity | Part No. |
|--------------|--------|----------|----------|
| 25 mg | 2 ml | 1 | N9306569 |
| 50 mg | 2 ml | 1 | N9306570 |
| 100 mg | 2 ml | 1 | N9306571 |

Supra-Clean LCC

Columns

| Media Weight | Volume | Quantity | Part No. |
|--------------|--------|----------|----------|
| 500 mg | 3 ml | 50 | N9306643 |
| 500 mg | 6 ml | 30 | N9306641 |

Supra-Poly HLB Columns and 96 Well Plates:

- Contains macro-porous polymers with ultra-pure, pharmaceutical grade spherical particles
- Shorter analysis times, greater load capacity and reduced solvent usage
- Ideal for high throughput assays

Supra-Poly HLB

30 µm Columns

| Media Weight | Volume | Quantity | Part No. |
|--------------|---------|----------|----------|
| 30 mg | 1 ml | 50 | N9306650 |
| 50 mg | 1 ml | 50 | N9306655 |
| 60 mg | 1 ml | 50 | N9306656 |
| 100 mg | 1 ml | 50 | N9306657 |
| 30 mg | 3 ml | 50 | N9306651 |
| 60 mg | 3 ml | 50 | N9306658 |
| 100 mg | 3 ml | 50 | N9306659 |
| 200 mg | 3 ml | 50 | N9306660 |
| 500 mg | 3 ml | 30 | N9306661 |
| 100 mg | 6 ml* | 30 | N9306672 |
| 150 mg | 6 ml | 30 | N9306662 |
| 200 mg | 6 ml | 30 | N9306663 |
| 200 mg | 6 ml* | 30 | N9306673 |
| 500 mg | 6 ml* | 30 | N9306674 |
| 500 mg | 6 ml | 30 | N9306664 |
| 500 mg | 15 ml | 20 | N9306665 |
| 1 g | 15 ml | 20 | N9306666 |
| 30 mg | 15 ml** | 50 | N9306668 |
| 60 mg | 15 ml** | 50 | N9306669 |
| 100 mg | 15 ml** | 50 | N9306670 |
| 200 mg | 15 ml** | 50 | N9306671 |
| 1 g | 25 ml | 20 | N9306667 |

* Glass columns ** LRC columns

30 µm 96 Well Plates

| Media Weight | Volume | Quantity | Part No. |
|--------------|--------|----------|----------|
| 30 mg | 2 ml | 1 | N9306698 |
| 50 mg | 2 ml | 1 | N9306699 |
| 60 mg | 2 ml | 1 | N9306700 |

60 µm Columns

| Media Weight | Volume | Quantity | Part No. |
|--------------|---------|----------|----------|
| 30 mg | 1 ml | 50 | N9306652 |
| 50 mg | 1 ml | 50 | N9306675 |
| 60 mg | 1 ml | 50 | N9306676 |
| 100 mg | 1 ml | 50 | N9306677 |
| 30 mg | 3 ml | 50 | N9306653 |
| 60 mg | 3 ml | 50 | N9306678 |
| 100 mg | 3 ml | 50 | N9306679 |
| 200 mg | 3 ml | 50 | N9306680 |
| 500 mg | 3 ml | 30 | N9306681 |
| 100 mg | 6 ml* | 30 | N9306692 |
| 150 mg | 6 ml | 30 | N9306682 |
| 200 mg | 6 ml | 30 | N9306683 |
| 200 mg | 6 ml* | 30 | N9306693 |
| 500 mg | 6 ml | 30 | N9306684 |
| 500 mg | 15 ml | 20 | N9306685 |
| 500 mg | 6 ml* | 30 | N9306694 |
| 1 g | 15 ml | 20 | N9306686 |
| 30 mg | 15 ml** | 50 | N9306688 |
| 60 mg | 15 ml** | 50 | N9306689 |
| 100 mg | 15 ml** | 50 | N9306690 |
| 200 mg | 15 ml** | 50 | N9306691 |
| 1 g | 25 ml | 20 | N9306687 |

* Glass columns ** LRC columns

60 µm 96 Well Plates

| Media Weight | Volume | Quantity | Part No. |
|--------------|--------|----------|----------|
| 30 mg | 2 ml | 1 | N9306695 |
| 50 mg | 2 ml | 1 | N9306696 |
| 60 mg | 2 ml | 1 | N9306697 |

SOLID PHASE EXTRACTION (SPE)

Supra-Poly Columns and 96 Well Plates:

- Contains macro-porous polymers with ultra-pure, pharmaceutical grade spherical particles
- Shorter analysis times, greater load capacity and reduced solvent usage
- Ideal for high throughput assays

Supra-Poly Extreme Capacity 1500 m²/g (XC)

Columns

| Media Weight | Volume | Quantity | Part No. |
|--------------|--------|----------|----------|
| 30 mg | 1 ml | 50 | N9306441 |
| 50 mg | 1 ml | 50 | N9306500 |
| 60 mg | 1 ml | 50 | N9306501 |
| 100 mg | 1 ml | 50 | N9306403 |
| 60 mg | 3 ml | 50 | N9306502 |
| 100 mg | 3 ml | 50 | N9306440 |
| 200 mg | 3 ml | 50 | N9306428 |
| 200 mg | 6 ml | 30 | N9306635 |
| 500 mg | 6 ml | 30 | N9306405 |
| 1 g | 15 ml | 20 | N9306503 |

96 Well Plates

| Media Weight | Volume | Quantity | Part No. |
|--------------|--------|----------|----------|
| 30 mg | 2 ml | 1 | N9306557 |
| 50 mg | 2 ml | 1 | N9306558 |
| 60 mg | 2 ml | 1 | N9306559 |

Supra-Poly Extra Wide Particle 1200 m²/g (XWP)

Columns

| Media Weight | Volume | Quantity | Part No. |
|--------------|--------|----------|----------|
| 30 mg | 1 ml | 50 | N9306504 |
| 50 mg | 1 ml | 50 | N9306427 |
| 60 mg | 1 ml | 50 | N9306505 |
| 100 mg | 1 ml | 50 | N9306506 |
| 60 mg | 3 ml | 50 | N9306507 |
| 100 mg | 3 ml | 50 | N9306508 |
| 200 mg | 3 ml | 50 | N9306509 |
| 500 mg | 6 ml | 30 | N9306418 |
| 1 g | 15 ml | 20 | N9306510 |

96 Well Plates

| Media Weight | Volume | Quantity | Part No. |
|--------------|--------|----------|----------|
| 30 mg | 2 ml | 1 | N9306560 |
| 50 mg | 2 ml | 1 | N9306561 |
| 60 mg | 2 ml | 1 | N9306562 |

Supra-Poly Environmental (AEV)

Columns

| Media Weight | Volume | Quantity | Part No. |
|--------------|--------|----------|----------|
| 100 mg | 3 ml | 50 | N9306648 |

Supra-Poly Hydrophilic (ATH)

Columns

| Media Weight | Volume | Quantity | Part No. |
|--------------|--------|----------|----------|
| 100 mg | 3 ml | 50 | N9306646 |
| 200 mg | 3 ml | 50 | N9306638 |
| 200 mg | 6 ml | 30 | N9306636 |

Supra-Poly Lipophilic (ATL)

Columns

| Media Weight | Volume | Quantity | Part No. |
|--------------|--------|----------|----------|
| 100 mg | 3 ml | 50 | N9306647 |
| 200 mg | 3 ml | 50 | N9306639 |
| 200 mg | 6 ml | 30 | N9306637 |

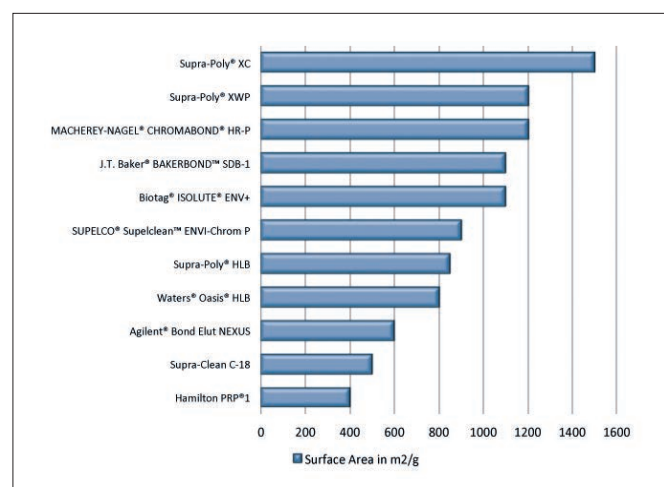

Compared to other industry leading SPE materials, our Extreme Capacity (XC) and Extra Wide Particles (XWP) lead market in surface area. This allows for higher capacities at lower bed weights.

SPE APPLICATION PACKS

Ideal for extraction of known entities from a variety of matrices, our packs are expertly tailored to meet your application needs and are designed to support major EPA methods and applications.

| Description | Media Weight | Volume | Quantity | Part No. |
|--|--------------|--------|----------|-----------------|
| Extraction of Basic Drugs from Biological Fluids | 200 mg | 3 ml | 50 | N9306605 |
| Extraction of Bisphenol A from Aqueous Matrix | 1 g | 6 ml | 30 | N9306613 |
| Extraction of Oil and Grease from Aqueous Matrix-EPA 1664 | 500 mg | 3 ml | 50 | N9306612 |
| | 1 g | 6 ml | 30 | N9306611 |
| Extraction of PAH from Soil and Oil | 1.5 g | 6 ml | 30 | N9306609 |
| Extraction of PAH from Soil and Oil (Glass Straight Column) | 1.5 g | 6 ml | 30 | N9306610 |
| Extraction of PAH from Water Containing Humic Acids | 1.5 g | 6 ml | 30 | N9306608 |
| Extraction of PAH from Water or Soil | 4 g | 6 ml | 30 | N9306606 |
| Extraction of PAH from Water or Soil (Glass Straight Column) | 4 g | 6 ml | 30 | N9306607 |
| Extraction of PCB from Oil | 1 g | 6 ml | 30 | N9306617 |
| | 1 g | 3 ml | 50 | N9306616 |
| Extraction of Pesticides and Herbicides from Aqueous Matrix | 500 mg | 3 ml | 50 | N9306614 |
| Extraction of Steroids from Biological Fluids | 500 mg | 6 ml | 30 | N9306615 |
| Extraction of SVOC from Water-EPA 525 | 1 g | 6 ml | 30 | N9306618 |

SPE SELECTION KITS

Enables quick column selection for development of reproducible and repeatable SPE methods.

| Description | Media Weight | Volume | Quantity | Part No. |
|--|--------------|--------|----------|-----------------|
| Pre-Concentration of Hydrophobic Compounds from Aqueous Matrix | 200 mg | 6 ml | 50 | N9306594 |
| | 200 mg | 3 ml | 50 | N9306595 |
| Extraction of Hydrophobic Compounds from Aqueous Matrix | 500 mg | 6 ml | 50 | N9306596 |
| | 500 mg | 3 ml | 50 | N9306597 |
| Pre-Concentration of Hydrophilic Compounds | 500 mg | 6 ml | 30 | N9306598 |
| | 500 mg | 3 ml | 30 | N9306599 |

| Description | Media Weight | Volume | Quantity | Part No. |
|---|--------------|--------|----------|-----------------|
| Removal of Polar Compounds from Aqueous and Organic Matrix | 500 mg | 6 ml | 30 | N9306600 |
| | 500 mg | 3 ml | 30 | N9306601 |
| Extraction of Acidic Basic and Neutral Compounds from Aqueous or Organic Matrix | 100 mg | 3 ml | 50 | N9306602 |
| Extraction of Carboxylic Acids and Strong Bases from Aqueous Matrix | 500 mg | 6 ml | 40 | N9306603 |
| Extraction of Weak Bases from Aqueous Matrix | 500 mg | 6 ml | 30 | N9306604 |

SPE VACUUM PUMPS, MANIFOLDS AND ACCESSORIES

SPE Vacuum Manifolds accommodate either 12 or 24 cartridges; 1, 3, 6, 15, and 25 mL columns can be used. Manifolds are equipped with a vacuum port to connect a standard laboratory vacuum pump. Vacuum pulls the sample through the stationary phase, metered by the stopcocks, to control the speed of the extraction process and the sample flow. Waste and wash solvents are discarded and analytes are collected in sample tubes below the manifold completing the extraction.

| Description | Qty | 12 Position Part No. | Qty | 24 Position Part No. |
|-----------------------------|-----|----------------------|-----|----------------------|
| Vacuum Manifold | 1 | N9306619 | 1 | N9306626 |
| Replacement Chamber (Glass) | 1 | N9306620 | 1 | N9306627 |
| Cover Gasket - 12 Position | 1 | N9306621 | 1 | N9306628 |
| Stopcocks - 12 Position | 12 | N9306624 | 24 | N9306631 |
| Needles - Polypropylene | 12 | N9306622 | 24 | N9306629 |
| Needles - Stainless Steel | 12 | N9306623 | 24 | N9306630 |
| Drying Attachment | 1 | N9306625 | 1 | N9306632 |

| Description | Qty | 20 L/min 115V | 60 L/min 115V | 17 L/min 230V | 58 L/min 230V |
|--------------|-----|-----------------|-----------------|-----------------|-----------------|
| Vacuum Pumps | 1 | N9308035 | N9308063 | N9308331 | N9308332 |



AS EASY AS ONE, TWO, SPE



Supra-d QuEChERS Dispersive SPE

Our Supra-d dispersive SPE extraction and clean-up kits have been customized for your specific sample preparation needs. They are designed for both steps of the QuEChERS method and each kit includes pre-prepared products for simplicity and error-free extractions. A certificate of quality is included in each kit, ensuring you have the best for your application. With our extensive line of dispersive SPE kits you'll be sure to find what you're looking for. Add our Supra-d dispersive SPE to your family of sample preparation products.

Features and Benefits:

- High recoveries are achieved for more accurate analyses
- Up to 4 times faster than traditional methods
- Low solvent usage and waste for maximum cost savings

PerkinElmer's Supra-d QuEChERS dispersive SPE turns sample preparation into an easy two-step process by using the QuEChERS method. QuEChERS (Quick, Easy, Cheap, Effective, Rugged, Safe) dispersive SPE, is the number one used sample preparation approach in pesticide residue analysis. It eliminates complex liquid extraction methods and extends the range of recovered pesticides. The QuEChERS procedure is fast and easy, improving lab productivity and resulting in fewer errors.

QUECHERS SIMPLE TWO-STEP PROCEDURE:

Step 1: Extraction

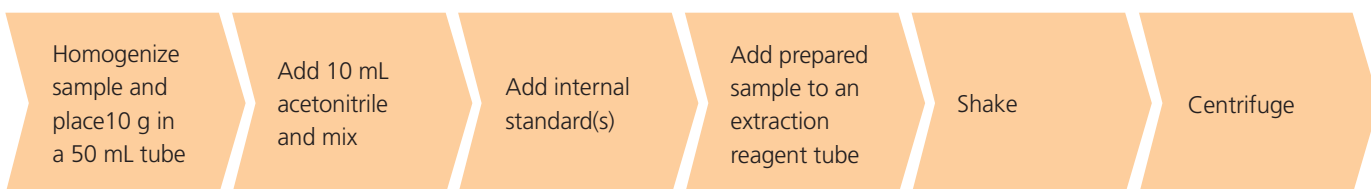

Step 2: Clean-Up



Supra-d QuEChERS For Multiple Pesticide Residue Analysis

PerkinElmer provides the most complete range of products for QuEChERS methodologies, offering all three standard QuEChERS methods: Original QuEChERS method, American AOAC Standard (Official Method 2007.01) QuEChERS method and European Standard (EN 15662) QuEChERS method.



Extraction Kits

| Method | Vol. | Qty. | MgSO4 | Na Acetate | Na Citrate | Na Citrate Sesquihydrate | NaCl | Part No. | Empty Tube Part No. | Powder Pack Part No. | Powder Pack (500/pk) Part No. |
|--------------|-------|------|-------|------------|------------|--------------------------|------|-----------------|---------------------|----------------------|-------------------------------|
| AOAC 2007.01 | 50 mL | 50 | 6 g | 1.5 g | | | | N9306900 | N9306935 | N9306936 | N9306939 |
| EN 15662 | 50 mL | 50 | 4 g | | 1 g | 0.5 g | 1 g | N9306901 | N9306935 | N9306937 | N9306940 |
| Original | 50 mL | 50 | 4 g | | | | 1 g | N9306902 | N9306935 | N9306938 | N9306941 |

AOAC 2007.01 Clean-up Kits

| Description | Vol. | Qty. | MgSO41 | PSA2 | C183 | PGC4 | Part No. |
|---|-------|------|---------|--------|--------|--------|-----------------|
| Fruit & Vegetables | 2 mL | 100 | 150 mg | 50 mg | | | N9306908 |
| Fruit & Vegetables | 15 mL | 50 | 1200 mg | 400 mg | | | N9306909 |
| Fruit & Vegetables with Fats and Waxes | 2 mL | 100 | 150 mg | 50 mg | 50 mg | | N9306910 |
| Waxed Fruit & Vegetables | 15 mL | 50 | 1200 mg | 400 mg | 400 mg | | N9306911 |
| Pigmented Fruit & Vegetables | 15 mL | 50 | 1200 mg | 400 mg | | 400 mg | N9306912 |
| Fruit & Vegetables with Pigments and Fats | 2 mL | 100 | 150 mg | 50 mg | 50 mg | 50 mg | N9306913 |
| Fruit & Vegetables with Pigments and Fats | 15 mL | 50 | 1200 mg | 400 mg | 400 mg | 400 mg | N9306914 |

EN 15662 Clean-up Kits

| Description | Vol. | Qty. | MgSO41 | PSA2 | C183 | PGC4 | Part No. |
|--|-------|------|--------|--------|--------|--------|-----------------|
| Fruit & Vegetables | 2 mL | 100 | 150 mg | 25 mg | | | N9306920 |
| Fruit & Vegetables | 15 mL | 50 | 900 mg | 150 mg | | | N9306921 |
| Fruit & Vegetables with Fats and Waxes | 2 mL | 100 | 150 mg | 25 mg | 25 mg | | N9306922 |
| Waxed Fruit & Vegetables | 15 mL | 50 | 900 mg | 150 mg | 150 mg | | N9306923 |
| Pigmented Fruit & Vegetables | 15 mL | 50 | 900 mg | 150 mg | | 15 mg | N9306924 |
| Pigmented Fruit & Vegetables | 2 mL | 100 | 150 mg | 25 mg | | 2.5 mg | N9306925 |
| High Pigmented Fruit & Vegetables | 2 mL | 100 | 150 mg | 25 mg | | 7.5 mg | N9306926 |
| High Pigmented Fruit & Vegetables | 15 mL | 50 | 900 mg | 150 mg | | 45 mg | N9306927 |

Clean-up Kit

| Description | Method | Vol. | Qty. | MgSO41 | PSA2 | C183 | PGC4 | Part No. |
|--------------|----------|-------|------|--------|--------|------|--------|-----------------|
| Clean-up Kit | Original | 15 mL | 50 | 900 mg | 300 mg | | 150 mg | N9306933 |

¹ MgSO4 removes excess water

² PSA removes sugars, fatty acids, organic acids, and anthocyanine pigments

³ C18 removes nonpolar interferences

⁴ PGC (carbon) removes pigments, sterols, and nonpolar interferences



Disposable Syringes

Designed for use with syringe filters, these disposable, sterile, polypropylene syringes are for general-purpose applications. Packaged in easy-to-open sealed package and they can be autoclaved out of the package.

| Description | Pack Size | Part No. |
|-----------------------|-----------|----------|
| Luer-Lock Tips, 1 mL | 100 | 02542890 |
| Luer-Lock Tips, 3 mL | 200 | 02542891 |
| Luer-Lock Tips, 5 mL | 100 | 02542892 |
| Luer-Lock Tips, 10 mL | 100 | 02542893 |

Ultramicro Volume Syringes

Recommended for liquid sample injections of less than 5 μL for gas chromatography. Syringes come standard with needle length of 7 cm – optimum for PerkinElmer injectors.

| Syringe Capacity | Gauge | O.D. | I.D. | Tip Description | Pack Size | Part No. |
|-------------------|-------|------|------|-----------------|-----------|----------|
| 0.5 μL | 26 | 0.47 | 0.1 | Bevel | 1 | N9302231 |
| 1.0 μL | 23 | 0.63 | 0.15 | Cone | 1 | 00230177 |
| 1.0 μL | 261 | 0.47 | 0.15 | Cone | 1 | 00230111 |
| 2.0 μL | 23 | 0.63 | 0.12 | Bevel | 1 | N9302235 |
| 5.0 μL | 23 | 0.63 | 0.37 | Cone | 1 | 00230178 |

¹ Recommended for PerkinElmer wide-bore capillary adapter

OPTIMIZE SAMPLE THROUGHPUT

The Quality You Need From A Partner You Trust

A broad variety of glass and plastic vials are essential to keeping all of your GC, LC and Headspace instruments running smoothly. Not only are the vial's dimensional qualities important for trouble-free runs, but the physical properties, like being free of contaminants, are equally important in order for your analysis to be accurate.

We're proud to offer you an expanded product selection which includes additional glass and plastic vial types, new caps and matching septa. All tested for the highest quality to meet both your application requirements and are guaranteed for fit and compatibility.

Why Choose PerkinElmer? One Word – Quality

Features and Benefits:

- Vials are made from Type I Borosilicate Glass. This glass meets all USP, JP and EP requirements. This glass is very hard and has a low expansion coefficient even at high temperature
- Vials are stringently tested using camera gauging technology to ensure final product meets all dimensional specifications
- All our vials, caps and septa are fit to perform on PerkinElmer and non-PerkinElmer instruments
- We stock a wide variety of sizes, colors and materials of vials, caps and septa
- All vials are packed in a clean room and those labeled with "LC Clean" include an additional certificate of analysis

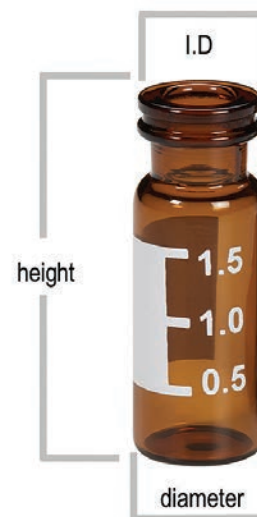

How to choose a Vial:

1. Choose a size. Vials come in a variety of sizes.

You measure a vial by looking at the:

- Volume (example is 2 mL)
- Diameter and height (example is 12 mm x 32 mm)
- I.D. of the neck (example is 11 mm)
- Finish (example is a snap top vial)

2. Choose a color.

If your sample is sensitive to light you may want to consider an amber vial.

3. Choose a material.

Vials are available in both glass and polyethylene. If you are analyzing a material that has proteins, you may want to consider using a polyethylene vial.



How to choose a Seal:

1. Choose a septa material.

Temperature, resistance to coring, storage shelf time, the material you are analyzing – all of these variables should be taken into consideration when choosing your septa material. Look to page 119 for an outline on which septa is best for you.

2. Decide between a pre-slit or non-slit septa.

Due to the technique and type of needle they use, pre-slit septa are ideal for LC systems, while non-slit septa are ideal for GC and GC/MS systems.

3. Match the size of the cap/septa with the size of your vial.

Do you need anything else?

We have a wide variety of crimpers, decappers, and vial trays to also make your analysis easier.



Autosampler Vials

PerkinElmer vials are manufactured to specific tolerances that are guaranteed to fit and perform with PerkinElmer and non-PerkinElmer instruments. Our vials are manufactured from Type I Borosilicate Glass, which meets all USP, JP, and EP Pharmacopeia requirements. The glass performs excellent at high temperatures and is chemical resistant to acidic, neutral and alkali solutions. All our vials are packed in a clean environment to ensure you receive contaminant free product every time.

Waste and Wash Vials, Caps and Septa for GC

| I.D. Size | Product Description | Part No. 1/Pack | Screw | |
|-----------|--|-----------------|-------------------|--------------------|
| | | | Part No. 100/pack | Part No. 1000/pack |
| 13 mm | Clear Glass Vial - 4 mL (15 x 45 mm) | 09923031 | N9306247 | |
| | 200 µL Vial Insert | | | N9302681 |
| | Support for Vial Insert | | | N9302682* |
| 13 mm | Black Cap with PTFE/Silicone (Ultra Low Bleed) Septa | | N9304141 | N9304142 |
| 13 mm | Black Phenolic Cap (no septa) | 09923032 | | |
| 13 mm | Silicone Septa (no cap) | | N9302780 | |

*N9302682 is packaged 500/pack

2 mL Vials (12 x 32 mm):

| I.D. Size | Vial Description | Crimp Top | | Screw Top | | Snap Top | |
|-----------|--|-------------------|--------------------|-------------------|--------------------|-------------------|--------------------|
| | | Part No. 100/pack | Part No. 1000/pack | Part No. 100/pack | Part No. 1000/pack | Part No. 100/pack | Part No. 1000/pack |
| 8 mm | Clear Glass | N9301069* | | | | N9302945 | |
| 9 mm | Clear Glass | | | | | N9306201 | |
| | Clear Glass with Write-on Patch and Fill Lines | | | | | N9307801 | |
| | Clear Glass with Write-on Patch and Fill Lines (Silanized) | | | | | N9304139 | |
| | Clear Polyethelene | | | | | N9301733 | |
| | Clear Polyethelene (300 µL capacity) | | | | | N9301732 | |
| | Amber Glass | | | | | N9306220 | |
| | Amber Glass with Write-on Patch and Fill Lines | | | | | N9307802 | |
| | Amber Glass with Write-on Patch and Fill Lines (Silanized) | | | | | N9304140 | |
| 10 mm | Clear Glass with Write-on Patch and Fill Lines | | | | | N9306053 | |
| | Amber Glass with Write-on Patch and Fill Lines | | | | | N9306057 | |
| 11 mm | Clear Glass | N9301385 | | N9303418 | | | |
| | Clear Glass with Write-on Patch and Fill Lines | N9306223 | | N9306207** | | | N9307017 |
| | Clear Glass with Write-on Patch and Fill Lines (Silanized) | N9304135 | | N9304137 | | | |
| | Amber Glass | N9302680 | | | | | |
| | Amber Glass with Write-on Patch and Fill Lines | N9302679 | | N9306208** | | N9307018 | |
| | Amber Glass with Write-on Patch and Fill Lines (Silanized) | N9304136 | | N9304138 | | | |

** N9301069 is packaged 200/pack ; ** Also includes grade levels

Autosampler Fused Vials And Vial Inserts

For easy sampling, try our vials with fused sample inserts. A variety of volumes are available in either clear or amber glass. Polyethylene option available also.



| I.D. Size | Capacity | Vial Type | Crimp Top | | Screw Top | | Snap Top | |
|-----------|----------|--------------------|-------------------|-------------------|-------------------|--------------------|-------------------|--------------------|
| | | | Part No. 100/Pack | Part No. 500/Pack | Part No. 100/Pack | Part No. 1000/Pack | Part No. 100/Pack | Part No. 1000/Pack |
| 8 mm | 100 µL | Clear Glass | | | | | | N9300713 |
| 8 mm | 100 µL | Amber Glass | | | | | | N9300714 |
| 8 mm | 200 µL | Clear Glass | | N9302136* | | | | |
| 9 mm | 300 µL | Clear Glass | | | | | | N9300715 |
| 9 mm | 300 µL | Amber Glass | | | | | | N9300716 |
| 10 mm | 300 µL | Clear Glass | | | | | | N9300717 |
| 10 mm | 300 µL | Amber Glass | | | | | | N9300718 |
| 11 mm | 300 µL | Clear Glass | N9300709 | | N9300711 | | | |
| 11 mm | 300 µL | Amber Glass | N9300710 | | N9300712 | | | |
| 11 mm | 600 µL | Clear Polyethylene | | N9302130 | | | | |

*N9302136 should be used with Glass Vial Support Sleeve (N9307027)

Autosampler Vial Inserts

Our vial inserts are made from the same Type 1, Class A borosilicate glass as our vials and can be used for maximum sample extraction. Vial inserts compatible with the following vials.



| Capacity | Dimensions | Qty. | Vial Insert Part No. | Crimp Top | | Screw Top | | Snap Top | |
|----------|--|----------|----------------------|-------------------|-------------------|-------------------|--------------------|-------------------|--------------------|
| | | | | Part No. 100/Pack | Part No. 500/Pack | Part No. 100/Pack | Part No. 1000/Pack | Part No. 100/Pack | Part No. 1000/Pack |
| 150 µL | 5 x 29 mm Spring (insert only fits 8 mm vial) | 100/Pack | N9300705 | | | | | | N9302945 |
| 200 µL | 5 x 32 mm Flat Bottom (insert only fits 8 mm vial) | 100/Pack | N9300706 | | | | | | N9302945 |
| 250 µL | 6 x 29 mm Spring (this insert fits any 9, 10 or 11 mm vial) | 100/Pack | N9300703 | N9301385 | | N9303418 | N9307018 | N9304139 | N9307017 |
| | | | | N9302679 | | N9304137 | | N9304140 | |
| | | | | N9302680 | | N9304138 | | N9306053 | |
| | | | | N9304135 | | N9306207 | | N9306057 | |
| | | | | N9304136 | | N9306208 | | N9306201 | |
| | | | | N9306223 | | | | N9306220 | |
| | | | | N9306231 | | | | N9307801 | |
| 400 µL | 6 x 31 mm Flat Bottom (this insert fits any 9, 10 or 11 mm vial) | 100/Pack | N9300704 | N9301385 | | N9303418 | N9307018 | N9304139 | N9307017 |
| | | | | N9302679 | | N9304137 | | N9304140 | |
| | | | | N9302680 | | N9304138 | | N9306053 | |
| | | | | N9304135 | | N9306207 | | N9306057 | |
| | | | | N9304136 | | N9306208 | | N9306201 | |
| | | | | N9306223 | | | | N9306220 | |
| | | | | N9306231 | | | | N9307801 | |
| | | | | N9307802 | | | | | |

Autosampler Caps And Septa

PerkinElmer offers a variety of caps and septa to fulfill your application needs. Our screw thread vial caps use the revolutionary Inter-Seal®. Using a process that bonds silicone/PTFE and other elastomeric compounds directly into thermoplastic closures eliminates liner fallout, while still providing the excellent resealability and multiple injection capability. No adhesives are used in this process, bonding the cap and septa at the molecular level of plastic and rubber. These septa have a very broad chemical resistance and can be used in many markets including: environmental, diagnostic packaging, pharmaceutical packaging, cosmetic and food packaging.



| I.D. Size | Septa Type | Cap Type (Pre-Assembled) | Crimp Top | | Screw Top | | Snap Top | |
|-----------|--|-----------------------------|----------------------|-----------------------|----------------------|-----------------------|----------------------|-----------------------|
| | | | Part No. 100/Pack | Part No. 1000/Pack | Part No. 100/Pack | Part No. 1000/Pack | Part No. 100/Pack | Part No. 1000/Pack |
| 8 mm | PTFE | Aluminum Cap | | N9302140 | | | | |
| | PTFE/Red Rubber | Aluminum Cap | | 03300806 | | | | |
| | PTFE/Silicone | Black Flanged Cap | | | | | N9303449 | |
| | PTFE/Silicone (Pre-Slit) | Polyethylene Cap with Slit | | | | N9302141 | | |
| 9 mm | PTFE/Red Rubber | Blue Cap | | | | | N9306200 | |
| | PTFE/Silicone | Blue Cap | | | | | N9306360 | N9306361 |
| | PTFE/Silicone (ultra-low bleed) | Blue Cap | | | | | N9306362 | |
| | PTFE/Silicone (Pre-Slit) | Blue Cap | | | | | N9306203 | N9306363 |
| | PTFE/Silicone (ultra-low bleed and Pre-Slit) | Blue Cap | | | | | N9306364 | N9306365 |
| 10 mm | PTFE/Red Rubber | Black Cap | | | | | N9306206 | |
| | PTFE/Silicone | Black Cap | | | | | N9306205 | |
| | PTFE/Silicone (Pre-Slit) | Black Cap | | | | | N9306052 | |
| 11 mm | PTFE/Red Rubber | Aluminum Cap (Silver) | N9306015* | | | | | |
| | PTFE/Red Rubber | Aluminum Cap (Blue) | N9302686 | | | | | |
| | PTFE/Red Rubber | Aluminum Cap (Green) | N9302684 | | | | | |
| | PTFE/Red Rubber | Aluminum Cap (Red) | N9302685 | | | | | |
| | PTFE/Silicone (white/red) | Aluminum Cap (Silver) | N9307823 | | | | | |
| | PTFE/Silicone (white/white) | Aluminum Cap (Silver) | N9306228 | | | | | |
| | PTFE/Silicone (white/red) | Clear Plastic Cap | | | N9303419 | | | |
| | PTFE/Silicone - pre-slit (white/red) | Clear Plastic Cap | | | N9303416 | | | |
| | PTFE/Silicone/PTFE | Aluminum Cap (Silver) | N9306229 | | | | | |
| | PTFE/Silicone/PTFE | Gold Magnetic Cap | N6356473 | | | | | |
| | PTFE/Silicone/PTFE | Clear Plastic Cap | | | N9303417 | | | |
| | Aluminum/PTFE | Aluminum Cap (Silver) | | N9302139** | | | | |
| | Black Viton | Aluminum Cap (Silver) | | N9302784 | | | | |

* Same as part number N9306230 ; **N9302139 is packaged 500/pack

| I.D. Size | Septa Type | Cap Type (Un-Assembled) | Crimp Top | | Screw Top | | Snap Top | |
|-----------|------------|-----------------------------|----------------------|-----------------------|---------------------|----------------------|----------------------|-----------------------|
| | | | Part No. 100/Pack | Part No. 1000/Pack | Part No. 12/Pack | Part No. 500/Pack | Part No. 100/Pack | Part No. 1000/Pack |
| 8 mm | | PTFE/Buytl | | | | | N9303442 | |
| | | Phenolic Cap | | | | | N9303441 | |
| 11 mm | | PTFE/Silicone | | | 00091357 | | | |
| | | PTFE/Silicone (Pre-Slit) | | | | N9307021 | | |
| | | Clear Plastic Cap with Slit | | | | N9307023 | | |
| | | Clear Plastic Cap with Slit | | | | 04978532 | | |

Autosampler Vial, Cap And Septa Convenience Kits

PerkinElmer understands your challenges and offers a variety of kits so that you can easily order and restock your laboratory supplies.



| I.D. Size | Septa Type | Cap Type | Vial Type | Screw Top | |
|------------------|--------------------------|-----------|--------------------------------------|-------------------|-------------------|
| | | | | Part No. 100/Pack | Part No. 500/Pack |
| 8 mm | PTFE/Silicone | Black Cap | Clear Glass | N9301945 | |
| 9 mm | PTFE/Red Rubber | Blue Cap | Clear Glass | N9300699 | |
| 9 mm (certified) | PTFE/Silicone | Blue Cap | Amber Glass | N9300719 | |
| 9 mm | PTFE/Silicone | Blue Cap | Clear Glass | N9300700 | |
| 9 mm (certified) | PTFE/Silicone | Blue Cap | Clear Glass | N9300707 | |
| 9 mm | PTFE/Silicone (Pre-Slit) | Blue Cap | Amber Polyethelene | N9301735 | |
| 9 mm (certified) | PTFE/Silicone (Pre-Slit) | Gray Cap | Amber Glass | N9300720 | |
| 9 mm | PTFE/Silicone (Pre-Slit) | Blue Cap | Clear Polyethelene | N9301736 | |
| 9 mm | PTFE/Silicone (Pre-Slit) | Blue Cap | Clear Polyethelene (300 µL capacity) | | N9306080 |
| 9 mm (certified) | PTFE/Silicone (Pre-Slit) | Gray Cap | Clear Glass | N9300708 | |
| 9 mm | PTFE/Silicone (Pre-Slit) | Blue Cap | Clear Glass | N9300701 | |
| 10 mm | PTFE/Silicone (Pre-Slit) | Black Cap | Clear Glass | N9300695 | N9300650 |
| 10 mm | PTFE/Silicone (Pre-Slit) | Black Cap | Amber Glass | N9300696 | |

* Same as part number N9306230 ; **N9302139 is packaged 500/pack

| I.D. Size | Septa Type | Cap Type | Vial Type | Crimp Top | | Snap Top | |
|-----------|--------------------------|-------------------|-------------|-------------------|-------------------|-------------------|--------------------|
| | | | | Part No. 100/Pack | Part No. 500/Pack | Part No. 100/Pack | Part No. 1000/Pack |
| 11 mm | PTFE/Red Rubber | Aluminum Cap | Clear Glass | N9300502 | N9300503 | | |
| 11 mm | PTFE/Silicone | Aluminum Cap | Clear Glass | N9300500 | | | |
| 11 mm | PTFE/Silicone | Clear Plastic Cap | Clear Glass | | | N9300702 | |
| 11 mm | PTFE/Silicone (Pre-Slit) | Clear Plastic Cap | Clear Glass | | | N9300697 | |
| 11 mm | PTFE/Silicone/PTFE | Aluminum Cap | Clear Glass | N9300501 | | | |
| 11 mm | PTFE/Silicone/PTFE | Clear Plastic Cap | Clear Glass | | | N9300698 | |

Autosampler Vial, Cap And Septa Starter Kits

PerkinElmer understands your challenges and offers a variety of kits so that you can easily evaluate, order and restock your laboratory supplies.



| Kits Include: | Part No. | Autosampler Starter Kit Part No. N6120105 | GC Educational Consumables Kit with Electronic Crimper Part No. N6500570 | GC Educational Consumables Kit with Manual Crimper Part No. N6500571 |
|---|-----------------|--|---|---|
| Manual Hand Crimper with 11 mm Jaws | 00090699 | 1 | | 1 |
| Manual Hand Decapper with 11 mm Jaws | N9301390 | 1 | | |
| Electronic Hand Crimper with 11 mm Jaws | N9304500 | | 1 | |
| 2 mL, 11 mm Clear, Crimp Vials | N9301385 | 100 | 200 | 200 |
| 2 mL, 11 mm Amber, Crimp Vials | N9302680 | 100 | | |
| 11 mm Aluminum Crimp Caps (Silver) with PTFE/Red Rubber Septa | N9306015 | 100 | 200 | 200 |
| 11 mm Aluminum Crimp Caps (Green) with PTFE/Red Rubber Septa | N9302684 | 100 | | |
| 11 mm Aluminum Crimp Caps (Red) with PTFE/Red Rubber Septa | N9302685 | 100 | | |
| 11 mm Aluminum Crimp Caps (Blue) with PTFE/Red Rubber Septa | N9302686 | 100 | | |
| 11 mm Silicone Septa (no cap) | N9302780 | 100 | | |
| 11 mm Vial Rack - 50 Vial Capacity | N9301303 | 1 | 2 | 1 |
| Syringe 9000 5.0 µL 0.63 mm o.d. | N6101390 | 1 | 2 | 2 |
| Elite 5 Column - 30 M x 0.25 mm x 0.25 µm | N9316076 | | 1 | 1 |

Headspace Vials

PerkinElmer offers a variety of GC headspace vials, caps and septa to fulfill your application needs. Our patented vial and cap design incorporates pressure-relief features which guarantee safe operation with the high pressure typically developed during thermostating. Ordinary vials and caps without these safety features may burst. All of our headspace vials have a greater wall thickness and round base which enables them to withstand pressure up to 60 psig. Low-volume sampling can be achieved by using a 6 mL vial and vial adapter. All PerkinElmer headspace vials are manufactured to specific tolerances that are guaranteed for fit and performance.



22 mL Vial Description (23 mm x 75.5 mm)

| Description | Crimp Top | | Screw Top | |
|--|----------------------|-----------------------|----------------------|-----------------------|
| | Part No. 100/Pack | Part No. 1000/Pack | Part No. 100/Pack | Part No. 1000/Pack |
| Clear Glass with "P" logo (Radius Bottom) | | B0104236 | N9306075 | N9306078 |
| Clear Glass with Write-on Patch and Fill Lines (Radius Bottom) | | | N9306240 | N9306241 |

20 mL Vial Description (23 mm x 75.5 mm)

| Description | Crimp Top | | Screw Top | |
|--|----------------------|-----------------------|----------------------|-----------------------|
| | Part No. 100/Pack | Part No. 1000/Pack | Part No. 100/Pack | Part No. 1000/Pack |
| Clear Glass (no logo) (Radius Bottom) | | N9306216 | | |
| Clear Glass with "P" logo (Radius Bottom) | N6356471* | | | |
| Clear Glass with Write-on Patch and Fill Lines (Radius Bottom) | N9303349 | N9303348 | | |
| | N6356472* | N9303351* | N9306242* | |
| Clear Glass with Write-on Patch and Fill Lines (Flat Bottom) | | N9303352* | | |

*For use with CTC headspace (actual size = 22.6 x 75.5mm)

10 mL Vial Description (21.75 mm x 46 mm)

| Description | Crimp Top | | Screw Top | |
|-----------------------------|----------------------|-----------------------|----------------------|-----------------------|
| | Part No. 100/Pack | Part No. 1000/Pack | Part No. 100/Pack | Part No. 1000/Pack |
| Clear Glass (Radius Bottom) | N6356478 | | N6356479 | |

6 mL Vial Description (22 mm x 38 mm)

| Description | Crimp Top | | Screw Top | |
|-----------------------------|----------------------|-----------------------|----------------------|-----------------------|
| | Part No. 125/Pack | Part No. 1000/Pack | Part No. 100/Pack | Part No. 1000/Pack |
| Clear Glass (Radius Bottom) | N9302134* | | | |

*Use with Low-Volume Vial Adapter N6120110 in order to fit TurboMatrix 16, TurboMatrix 40, HS 40 (XL), HS 100 or HS 101.

Note: this vial and adaptor will not work with the TurboMatrix 110 headspace sampler. This vial replaces part number B0104235.

Headspace Caps And Septa

Choose the right septa for your analysis. Although a wide variety of septa is available, chemical compatibility and temperature are the most critical to the analysis. Temperature applies not only to the vial, but also to the temperature of the instrument's needle used for pressurization and sample transfer, which is heated to prevent condensation. A needle temperature higher than the vial temperature setting can decompose the septum material. PTFE coated silicone and aluminum-coated silicone offer the highest temperature operating limits. (See Septa Recommended Chart for more details.)



| Septa Type | Aluminum Caps (Pre-Assembled) | Crimp Top | | Screw Top | |
|---------------------------------------|--|----------------------|-----------------------|----------------------|-----------------------|
| | | Part No. 100/Pack | Part No. 1000/Pack | Part No. 100/Pack | Part No. 1000/Pack |
| Butyl (red) | Aluminum Cap, Star Spring and Septa | N9304143 | N1010070 | | |
| Butyl (gray) | Aluminum Cap, Star Spring and Septa | N9306269 | N9306268 | | |
| PTFE/Butyl (red) | Aluminum Cap, Star Spring and Septa | N9304144 | B4000025 | | |
| PTFE/Butyl (gray) | Aluminum Cap, Star Spring and Septa | N9306265 | N9306264 | | |
| PTFE/Butyl (gray) | Aluminum Cap | | N9302981 | | |
| PTFE/Butyl (Pharma Fix Septa) | Aluminum Cap | N9306224 | | | |
| PTFE/Red Rubber (red) | Aluminum Cap, Star Spring and Septa | N9304147 | N9302978 | | |
| PTFE/Silicone (white) | Aluminum Cap, Star Spring and Septa | N9304146 | B4000022 | | |
| PTFE/Silicone (white) Ultra Bleed | Aluminum, Skived Pressure Relief | | N9302975 | | |
| PTFE/Silicone (white) Ultra Bleed | Aluminum, Skived (non-Pressure Relief) | | N9302977 | | |
| PTFE/Silicone (natural) Extreme Bleed | Aluminum, Skived (non-Pressure Relief) | | N9302976 | | |
| Aluminum/Silicone | Aluminum Cap, Star Spring and Septa | N9304145 | B4000028 | | |
| Septa Type | Steel Magnetic Caps (Pre-Assembled) | | | | |
| Butyl (gray) | Steel Magnetic Cap | N6356561 | | | |
| PTFE/Butyl (red) | Steel Magnetic Cap | | | N9306076 | |
| PTFE/Butyl (gray) | Steel Magnetic Cap | N6356560 | | N6356477 | |
| PTFE/Butyl (blue) | Bi-Metal Magnetic Cap | N6356565 | | | |
| PTFE/Butyl (Pharma Fix Septa) | Steel Magnetic Cap | N6356562 | | | |
| PTFE/Silicone (red) | Steel Magnetic Cap | | | N6356474 | |
| PTFE/Silicone (white) | Steel Magnetic Cap | | | N9306077 | |
| PTFE/Silicone (natural) | Steel Magnetic Cap | N6356558 | | | |
| PTFE/Silicone (blue) | Steel Magnetic Cap | N6356559 | | N6356475 | |
| PTFE/Silicone (blue) SPME Liner | Steel Magnetic Cap | N6356564 | | | |
| PTFE/Silicone (blue) | Bi-Metal Magnetic Cap | N6356566 | | | |
| Aluminum/Silicone | Steel Magnetic Cap | N6356563 | | | |
| Septa Type | Aluminum Caps (Un-Assembled) | | | | |
| Butyl (red) | Aluminum Cap, Star Spring and Septa | B0159356 | B0159357 | | |
| Butyl (gray) | Aluminum Cap, Star Spring and Septa | N9306270 | N9306271 | | |
| Butyl (gray) Stopper | Aluminum Cap (Ridged) | | N9303350 | | |
| Butyl (gray) Stopper | Aluminum Cap | | B0110728 | | |
| Butyl (gray) Stopper | | B0038137 | | | |
| PTFE/Butyl (red) | Aluminum Cap, Star Spring and Septa | B0104239 | B0104240 | | |
| PTFE/Butyl (gray) | Aluminum Cap, Star Spring and Septa | N9306266 | N9306267 | | |
| PTFE/Red Rubber (red) | Aluminum Cap, Star Spring and Septa | N9302979 | N9302980 | | |
| PTFE/Silicone (white) | Aluminum Cap, Star Spring and Septa | B0104241 | B0104242 | | |
| Aluminum/Silicone | Aluminum Cap, Star Spring and Septa | B0104243 | B0104244 | | |
| | Aluminum Cap | B0099814 | N9302969 | | |

Cap and Septa Compatibility

| Temperature Range | Aluminum/Silicone Up to 220 °C | PTFE/Silicone up to 210 °C | PTFE/Red Rubber up to 160 °C | PTFE/Butyl (Red or Gray) up to 130 °C | Red or Gray Butyl up to 130 °C |
|------------------------------|-----------------------------------|-------------------------------|---------------------------------|--|-----------------------------------|
| Use for multiple injections? | No | Yes | Yes | No | No |
| Price per 1000 | Most Expensive | Expensive | Economical | Economical | Very Economical |
| Resistance to coring | Good | Excellent | Good | Low | Low |
| Recommended for storage | Yes | Yes | Yes | No | No |

Headspace Vial, Cap And Septa Convenience Kits

PerkinElmer understands your challenges and offers a variety of kits so that you can easily order and restock your laboratory supplies.



| Septa Type | Cap Type | Vial Type | Crimp Top | |
|-------------------------|--|--|-------------------|-------------------|
| | | | Part No. 100/Pack | Part No. 500/Pack |
| Butyl (red) | Aluminum Cap, Star Spring and Septa | 20 mL Crimp Top Clear Glass with Write on Patch and Fill Lines | N9303990 | |
| Butyl (gray) | Aluminum Cap, Star Spring and Septa | 20 mL Crimp Top Clear Glass with Write on Patch and Fill Lines | N9306269 | |
| PTFE/Butyl (red) | Aluminum Cap, Star Spring and Septa | 20 mL Crimp Top Clear Glass with Write on Patch and Fill Lines | N9303991 | |
| PTFE/Butyl (gray) | Aluminum Cap, Star Spring and Septa | 20 mL Crimp Top Clear Glass with Write on Patch and Fill Lines | N9306265 | |
| PTFE/Silicone (natural) | Aluminum, Skived Pressure Relief (extreme bleed) | 20 mL Crimp Top Clear Glass with Write-on Patch and Fill Lines (Flat Bottom) | | N9300901 |
| PTFE/Silicone (white) | Aluminum, Skived Pressure Relief (ultra bleed) | 20 mL Crimp Top Clear Glass with Write-on Patch and Fill Lines (Flat Bottom) | | N9300902 |
| PTFE/Silicone (white) | Aluminum, Skived (ultra bleed) | 20 mL Clear Glass with Write-on Patch and Fill Lines (Flat Bottom) | | N9300903 |
| PTFE/Silicone (white) | Aluminum Cap, Star Spring and Septa | 20 mL Crimp Top Clear Glass with Write on Patch and Fill Lines | N9303992 | |
| Aluminum/Silicone | Aluminum Cap, Star Spring and Septa | 20 mL Crimp Top Clear Glass with Write on Patch and Fill Lines | N9303993 | |

| Septa Type | Cap Type | Vial Type | Screw Top |
|---------------|---------------------------------------|---|-------------------|
| | | | Part No. 100/Pack |
| PTFE/Silicone | Open Top Gray Polypropylene Screw Cap | 40 mL Screw Top Clear Glass (24 mm x 98 mm) | N6352030 |
| PTFE/Silicone | Open Top Gray Polypropylene Screw Cap | 40 mL Screw Top Amber Glass (24 mm x 98 mm) | N6352031 |
| PTFE/Silicone | | | N6352032 |
| | Open Top Gray Polypropylene Screw Cap | | N6352033* |



*N6352033 is only available in 72/pack

Headspace Starter Kits

We offer a variety of headspace consumables so you can evaluate different types of septa and vials for your sampling requirements.



| Kits Include: | Part No. | Headspace Starter Kit 500 | Headspace Starter Kit 100 | Headspace Mini Starter Kit | Headspace Mini Starter Kit 1000 |
|---|-----------------|---------------------------|---------------------------|----------------------------|---------------------------------|
| | | Part No. B0505601 | Part No. N6710195 | Part No. N6710197 | Part No. N6710198 |
| 20 mm Hand Crimper | N9302785 | 1 | 1 | 1 | 1* |
| 20 mL Clear Glass Crimp Top Vials | N9306079 | 500 | 500 | 100 | 1000 |
| PTFE/Butyl (red) Septa with Pre-Assembled Aluminum Crimp Caps | B0104239 | 100 | 100 | 100 | |
| PTFE/Silicone (white) Septa with Pre-Assembled Aluminum Crimp Caps | B0104241 | 100 | 100 | 100 | 1000 |
| Aluminum/Silicone Septa with Pre-Assembled Aluminum Crimp Caps | B0104243 | 100 | 100 | 100 | |
| 20 mL Clear Glass Screw Top Vials | N9306075 | 500 | 100 | 100 | |
| PTFE/Butyl (red) Septa with Steel Magnetic Screw Caps | N9306076 | 100 | 100 | 100 | |
| PTFE/Silicone (white) Septa with Steel Magnetic Screw Caps | N9306077 | 100 | 100 | 100 | |
| Needle Seal Assemblies | B0500833 | 2 | 2 | 2 | |
| O-Rings | B0198110 | 10 | 10 | 10 | |
| Pressure Gauge with Needle for Vials | B0501377 | 1 | 1 | 1 | |
| Static Headspace GC Theory and Practice™ book by B. Kolb and L.S. Ettre | N1011210 | 1 | 1 | | |

* This kit includes an Ergonomic Hand Crimper

ELECTRONIC HANDHELD AND BENCHTOP

Crimping Tools And Vial Accessories

Whatever your need may be, PerkinElmer offers a wide range of crimping tools for your convenience. Our universal voltage, precision control, power crimpers with adjustable settings are designed to deliver hundreds of crimps on a single battery charge.



Headspace Crimper and Decapper Tools

| Description | Quantity | Part No. |
|--|----------|----------|
| Benchtop Crimper | 1 | N6621006 |
| Benchtop Crimper Jaws - 20 mm | 1 | N6621009 |
| Electronic Hand Crimper - 20 mm | 1 | N9304501 |
| Electronic Hand Decapper - 20 mm | 1 | N9304503 |
| Manual Hand Crimper - 20 mm | 1 | N9302785 |
| Manual Hand Crimper (Ergonomic) - 20 mm | 1 | N6621037 |
| Manual Hand Decapper - 20 mm | 1 | N9301270 |
| Manual Hand Decapper (Ergonomic) - 20 mm | 1 | N6621038 |



Autosampler Crimper and Decapper Tools

| Description | Quantity | Part No. |
|---|----------|----------|
| Benchtop Crimper | 1 | N6621006 |
| Benchtop Crimper Jaws - 11 mm | 1 | N6621008 |
| Electronic Hand Crimper - 11 mm | 1 | N9304500 |
| Electronic Hand Decapper - 11 mm | 1 | N9304502 |
| Manual Hand Crimper - 8 mm | 1 | N9306127 |
| Manual Hand Crimper - 11 mm | 1 | 00090699 |
| Manual Hand Crimper (Ergonomic) - 11 mm | 1 | N6621035 |
| Manual Hand Decapper - 11 mm | 1 | N9301390 |
| Manual Hand Decapper (Ergonomic) - 11mm | 1 | N6621036 |



Vial Racks

| Description | Quantity | Part No. |
|------------------------------------|----------|----------|
| 11 mm Vial Rack - 50 Vial Capacity | 1 | N9301303 |
| 20 mm Vial Rack - 36 Vial Capacity | 1 | N9301304 |

VERIFY QUANTIFY SIMPLIFY

The Flexar SQ 300 MS

Ideal for a variety of analyses, this single quadrupole detector brings the unsurpassed sample insight of mass spectrometry to liquid chromatography applications. The Flexar SQ 300 MS™ is an integral part of the powerful and flexible Flexar LC product line. It features a revolutionary interchangeable probe and unique multi-stage ion path for exceptional sensitivity.

Measuring has never been easier with the Flexar SQ 300 MS. It provides the simplest route to exactly the information you need — quickly. As part of the Flexar LC platform, labs can expect exceptional chromatography coupled with an innovative rugged single quadrupole mass spectrometer that offers:

- Exceptional front-end chromatographic separation capabilities
- Flexible, modular components to suit any LC/MS analytical need
- The widest selection of operating pressures to address throughput needs

The Flexar SQ 300 MS has three ion source options that allow you to specifically address your analytical needs:

- Ultraspray™ Electro spray Interface (ESI)
- Dual-probe Ultraspray2™ (ESI)
- Atmospheric Pressure Chemical ionization (APCI)

Powered by the PerkinElmer Chromera® software, instrument control and data acquisition are faster and easier than ever.

Calibration Vials and Caps

| Description | Quantity | Part No. |
|---|----------|----------------------|
| 50ML Polypropylene Calibration Vial | Each | MZ108391-5001 |
| 50ML Polypropylene Calibration Vial Cap | Each | MZ108391-5002 |



Tuning and Calibration Reagents

| Description | Size | Part No. |
|---|--------|--------------------|
| ESI Tuning and Calibration Reagent (Required for AxION TOF) | 100 mL | ZG2421A |
| ESI Tuning and Calibration Reagent - low concentration (For AxION TOF) | 100 mL | ZG196985000 |
| APCI Tuning and Calibration Reagent (Required for APCI or DSA Sources with AxION TOF) | 100 mL | MZ331300 |
| APCI Tuning and Calibration Reagent - low concentration (For APCI, not recommended for DSA) | 100 mL | MZ331301 |

Calibration Solutions

| Description | Part No. |
|-----------------------------------|-----------------|
| Calibration Mix LC/MS (+) ION Mix | MZ301198 |
| Calibration Mix LC/MS (-) ION Mix | MZ301199 |

Test Kits

| Description | Part No. |
|--|-----------------|
| SQ300 Installation Performance Test Kit | MZ300061 |
| SQ300 Customer Performance Test Kit | MZ300085 |
| Caffeine Quantitative Test Kit | MZ300095 |
| SQ300 ESI Positive and Negative Test Kit | MZ300096 |

Spare Syringes and Needles (for Syringe Pump)

| Description | Part No. |
|--|-----------------|
| Hamilton 500uL Gas Tight Syringe (No Needle) | 09220120 |
| Hamilton Replacement 6-pack of Needles | 09220122 |

AxION Separation Probes

The innovative separation probes and holders facilitate chromatography directly at the ionization source. This minimizes dead volume effects in the system for superior signal-to-noise ratios, enhanced sensitivity and narrower peaks. Compatible with LC/MS systems using Flexar SQ300 or AxION 2 TOF MS.

| Description | Quantity | Part No. |
|--------------------------------|----------|-----------------|
| Probe Column - 2.1 mm x 5 mm | Each | N9304550 |
| Probe Column - 2.1 mm x 10 mm | Each | N9304551 |
| Probe Column - 2.1 mm x 50 mm | Each | N9304554 |
| Probe Column - 2.1 mm x 100 mm | Each | N9304556 |
| Probe Holder - 5 mm | Each | N9304552 |
| Probe Holder - 10 mm | Each | N9304553 |
| Probe Holder - 50 mm | Each | N9304555 |
| Probe Holder - 100 mm | Each | N9304557 |

Spare Probe Assemblies / Dielectric Capillary

| Description | Part No. |
|---|-----------------------|
| ESI Probe and Capillary Entrance Cone Kit | MZ300503 |
| Capillary Entrance Cone | MZ105094 |
| ESI Probe | MZ109197 |
| Dielectric Capillary | MZ105057-60180 |
| Quartz Tube for APCI | MZ109004 |
| Corona Needle for APCI | MZ301193 |
| ESI needle (tube) 0.006 " | MZ101903-17 |

LC/MS Filtration System

High Capacity Hydrocarbon Trap

- Contains 750 cc of preconditioned activated charcoal.
- Stainless steel body. ¼" brass compression fittings with ferrules for installation.
- Maximum pressure 200 psi.
- Recommended flow rate up to 2 L per minute.
- Will remove hydrocarbon impurities (50 ppm or less) from inert gases, nitrogen and hydrogen at room temperature to low ppb range.
- Capacity of 67 g of hydrocarbons C5 and heavier.
- 10 µ stainless steel porous frits protect gas stream from particulates.
- Individually helium leak tested. Shipped filled with helium.



| Description | Part No. |
|-------------------------|-----------------|
| LC/MS Filtration System | N9301208 |

Custom Benches

| Description | Part No. |
|--|-----------------|
| 120V Bench with Ventilated, Sound Dampened Pump Enclosure | N2911197 |
| 120V Bench with Monitor/Keyboard Arm, Side Shelf and Ventilated, Sound Dampened Pump Enclosure | N2911196 |
| 230V Bench with Ventilated, Sound Dampened Pump Enclosure | N2911199 |
| 230V Bench with Monitor/Keyboard Arm, Side Shelf and Ventilated, Sound Dampened Pump Enclosure | N2911198 |
| Roughing Pump Box with Acoustically Insulated Pump Enclosure | N8141230 |
| Uninterrupted Power Supply (UPS) | N0777511 |

LC/MS Consumables and Accessories

| Description | Pkg | Part No. |
|--|-----|-----------------|
| Certified LC Clean™ Non-Slit, Screw Top Cap/Vial Convenience Kit (Clear) | 100 | N9300707 |
| Certified LC Clean™ Pre-Slit, Screw Top Cap/Vial Convenience Kit (Clear) | 100 | N9300708 |
| Certified LC Clean™ Non-Slit, Screw Top Cap/Vial Convenience Kit (Amber) | 100 | N9300719 |
| Certified LC Clean™ Pre-Slit, Screw Top Cap/Vial Convenience Kit (Amber) | 100 | N9300720 |
| 96-well 7 mm Pre-slit Silicone Plate Mat/Seal | 10 | N9302555 |
| 96-well 'Deep-well' Microtiter Polypropylene Plate | 5 | N9302560 |
| 96-well Microtiter Polypropylene Plate | 1 | N9302562 |
| Barcode labels (25 sheets; 270 labels/sheet) | 25 | 09410105 |
| Edwards Rough Pump Oil (1 liter). Note: pump oil change requires 2 liters | 1 | MZ109017 |

LC/MS Caps

| Description | Part No. |
|----------------------------------|-----------------|
| 100 pg/µl Caffeine Standard | MZ301236 |
| Sampling Screen | MZ305382 |
| Capillary Sample Tubes (100/pkg) | MZ305385 |

INNOVATION TO THE CORE

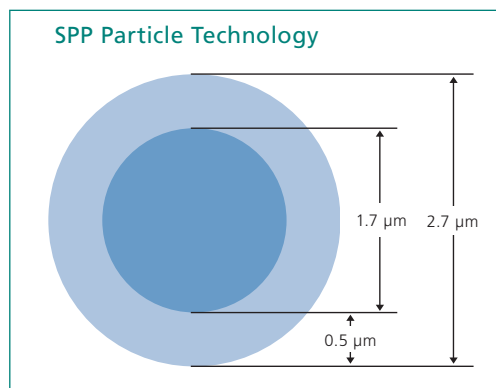

Smaller in size and innovative in design, superficially porous particles are made by fusing a porous silica layer to a solid inner core.

Brownlee SPP HPLC and UHPLC Column Solutions

Say goodbye to the limitations of traditional columns and experience greater speed, lasting durability and better results from your Liquid Chromatography instrument.

Brownlee Superficially Porous Particle (SPP) columns produce sharper peaks and faster separation results. These results are possible due to their breakthrough particle design and size. Brownlee SPP columns use 2.7 µm particles comprised of a thin outer shell of high-quality porous silica fused to a solid inner core. This advanced design allows for a shorter diffusion path, reducing the time solute molecules spend inside the particles while passing through the stationary phase.

Get the speed and efficiency of sub-2 mm UHPLC columns at ~ 50% the backpressure with Brownlee 2.7 µm SPP columns.

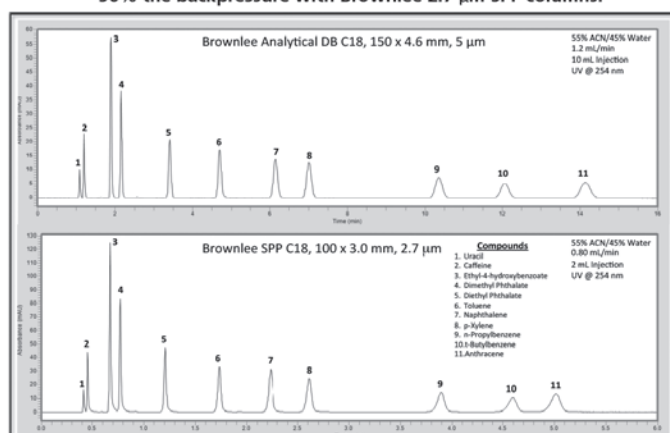

Brownlee SPP Phases and Applications

| UHPLC Phases* | PoreSize (Å) | Coverage (µmol/m ²) | pH Range | Temp Limit (°C) | Applications | Chromatographic Properties |
|--------------------------------|--------------|---------------------------------|----------|-----------------|--|---|
| C18 | 90 | 3.5 | 2 to 9 | 60 | General Purpose Octadecyl phase for reversed phase separations. | A high-purity column that exhibits excellent peak shape for a wide range of compounds. |
| C8 | 90 | 3.7 | 2 to 9 | 60 | General Purpose Octyl phase for reversed phase separations when less retention than a C18 is desired. | High purity reversed phase packing that exhibits excellent peak shape for a wide range of compounds. |
| HILIC** | 90 | N/A | 2 to 8 | 60 | General purpose bare silica column for normal phase and HILIC applications. | High purity silica substrate. |
| Peptide ES-C18** | 160 | 2.0 | 1 to 8 | 90 | Sterically protected ligand (isobutyl - side chains), results in an extra stable bonded phase at low pH where most peptide separations are performed. | The 160 Angstrom pore size was specially chosen for the molecular weight range of peptides. The ligand was chosen due to its sterically protected bonding technology that inhibits acid hydrolysis of the siloxane bonds, even under extremes of high temperature and low pH. |
| PPF (pentafluoro-phenylpropyl) | 90 | 3.6 | 2 to 8 | 60 | Highly retentive and selective for protonated basic analytes and molecules containing aromatic moieties. | End-capped pentafluorophenyl with a propyl spacer. |
| PhenylHexyl | 90 | 3.0 | 2 to 9 | 60 | Alternative selectivity to alkyl bonded phases, recommended for aromatic groups. Compatible with highly aqueous mobile phases to facilitate the retention and separation of polar compounds. | Base-deactivated for good peak shapes when separating basic compounds. Hexyl spacer provides optimal flexibility for phenyl ring to facilitate π-π interactions with solutes. |
| RP-Amide | 90 | 3.0 | 2 to 9 | 60 | Excellent phase for significantly increasing the retention and selectivity of acids, for symmetrical peak shapes of bases, zwitterions and other polar compounds. | Base-deactivated phase with a polar group within the alkyl bonded phase. Provides unique selectivity and a high level of base deactivation while reducing or eliminating the need for mobile phase additives. |

* Maximum pressure 9,000 p.s.i. for all columns. All particle sizes are 2.7 µm.
 **Not end-capped. All others end-capped.

PERFORMANCE FOR EVERY PHASE

Brownlee SPP Columns



| Phase | Length (mm) | 2.1 mm i.d. Part No. | 3.0 mm i.d. Part No. | 4.6 mm i.d. Part No. |
|----------------|-------------|----------------------|----------------------|----------------------|
| C18 | 20 | N9308400 | N9308406 | N9308412 |
| | 30 | N9308401 | N9308407 | N9308413 |
| | 50 | N9308402 | N9308408 | N9308414 |
| | 75 | N9308403 | N9308409 | N9308415 |
| | 100 | N9308404 | N9308410 | N9308416 |
| | 150 | N9308405 | N9308411 | N9308417 |
| Peptide ES-C18 | 30 | N9308450 | N9308455 | N9308460 |
| | 50 | N9308451 | N9308456 | N9308461 |
| | 75 | N9308452 | N9308457 | N9308462 |
| | 100 | N9308453 | N9308458 | N9308463 |
| | 150 | N9308454 | N9308459 | N9308464 |
| C8 | 20 | N9308418 | | N9308429 |
| | 30 | N9308419 | N9308424 | N9308430 |
| | 50 | N9308420 | N9308425 | N9308431 |
| | 75 | N9308421 | N9308426 | N9308432 |
| | 100 | N9308422 | N9308427 | N9308433 |
| | 150 | N9308423 | N9308428 | N9308434 |
| PFP | 20 | N9308465 | | |
| | 30 | N9308466 | N9308471 | N9308476 |
| | 50 | N9308467 | N9308472 | N9308477 |
| | 75 | N9308468 | N9308473 | N9308478 |
| | 100 | N9308469 | N9308474 | N9308479 |
| | 150 | N9308470 | N9308475 | N9308480 |
| Phenyl Hexyl | 20 | N9308481 | | |
| | 30 | N9308482 | N9308487 | N9308492 |
| | 50 | N9308483 | N9308488 | N9308493 |
| | 75 | N9308484 | N9308489 | N9308494 |
| | 100 | N9308485 | N9308490 | N9308495 |
| | 150 | N9308486 | N9308491 | N9308496 |
| RP-Amide | 20 | N9308497 | | |
| | 30 | N9308498 | N9308503 | N9308508 |
| | 50 | N9308499 | N9308504 | N9308509 |
| | 75 | N9308500 | N9308505 | N9308510 |
| | 100 | N9308501 | N9308506 | N9308511 |
| | 150 | N9308502 | N9308507 | N9308512 |
| HILIC | 30 | N9308435 | N9308424 | N9308430 |
| | 50 | N9308420 | N9308425 | N9308431 |
| | 75 | N9308421 | N9308426 | N9308432 |
| | 100 | N9308422 | N9308427 | N9308433 |
| | 150 | N9308423 | N9308428 | N9308434 |

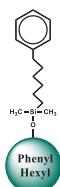
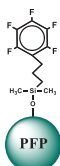
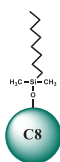

SPP Guard Columns (3 Packs)*

| Phase | Length (mm) | 2.1 mm i.d. Part No. | 3.0 mm i.d. Part No. | 4.6 mm i.d. Part No. |
|-------------------------|-------------|----------------------|----------------------|----------------------|
| C18 | 5 | N9308513 | N9308514 | N9308515 |
| Peptide ES-C18 | 5 | N9308528 | N9308529 | N9308530 |
| C8 | 5 | N9308522 | N9308523 | N9308524 |
| PFP | 5 | N9308531 | N9308532 | N9308533 |
| Phenyl Hexyl | 5 | N9308519 | N9308520 | N9308521 |
| RP-Amide | 5 | N9308516 | N9308517 | N9308518 |
| HILIC | 5 | N9308525 | N9308526 | N9308527 |
| SPP Guard Column Holder | | N9308534 | N9308534 | N9308534 |

* Maximum pressure 9,000 p.s.i. for all columns. All particle sizes are 2.7 μm.



THE TECHNOLOGY YOU NEED TO SEPARATE FROM THE PACK

Brownlee Instrument Optimizaton Kits

Brownlee SPP columns can be used to enhance the performance of virtually any PerkinElmer, Agilent®, or other manufacturer's HPLC or UHPLC system. Our SPP columns deliver resolution and speed similar to sub-2 µm UHPLC columns, but generate only 40% to 50% of the backpressure. By combining high efficiency and lower backpressure, Brownlee SPP columns make it possible to get "UHPLC-like" performance from your HPLC system.

PerkinElmer has created, tested and made the following PerkinElmer and Agilent® optimization kits available. Our OneSource Service Engineers are certified on all leading manufacturer instruments and can help optimize your instrument's performance.

PerkinElmer Optimization Kits

| Description | Part No. |
|--|-----------------|
| Series 200 LC or Flexar UHPLC systems with UV/Vis detector | N2920191 |
| Series 200 LC or Flexar UHPLC systems with PDA detector | N2920193 |

Agilent® Optimization Kits

| Description | Part No. |
|---|--------------------------|
| Extra column volume (ECV) - STD Autosampler and Variable Wavelength Detector (VWD) Optimization Kit | ZECVSTDVWD |
| ECV - STD Well Plate Autosampler and Diode Array Detector/Multiple Wavelength Detector (DAD/MWD) | ZECVSTDWPDADMWD |
| ECV - STD Autosampler sand DAD/MWD | ZECVSTDADMWD |
| ECV - STD Well Plate Autosampler and VWD | ZECVSTDWVWD |
| Ultra Low ECV - STD Autosampler and VWD | ZULECVSTDVWD |
| Ultra Low ECV - STD Well Plate Autosampler and DAD/MWD | ZULECVSTDWPDADMWD |
| Ultra Low ECV - STD Autosampler and DAD/MWD | ZULECVSTDADMWD |
| Ultra Low ECV - STD Well Plate Autosampler and VWD | ZULECVSTDWVWD |



Benefits:

- Generate UHPLC like separations on your standard HPLC system
- Achieve ultra fast performance and efficiency on your UHPLC system
- Run samples in a fraction of the time
- Experience significant savings through faster method development, column longevity and use of less mobile phase solvent



SELECT THE BEST COLUMN

Which Column Do I Need?

Having the right stationary phase for your separation is the first step in selecting the appropriate column. This should be based on sample solubility and on chemical differences among the sample compounds.

Depending on the mode of separation you will use, PerkinElmer has the right column for you. In reversed-phase separations, the mobile phase is more polar than the stationary phase. Sample hydrophobicity also is a major determinant of the separation mode. In reversed-phase separations, the mobile phase is more polar than the stationary phase, which is traditionally a straight alkyl chain, most often C18.

The majority of HPLC analyses are performed in reversed-phase mode, due to the fact that the analytes of interest can be dissolved in water, or mixtures of water and a polar organic solvent such as methanol or acetonitrile.

In normal phase separations, the mobile phase is less polar than the stationary phase. Cyano phases are commonly used in either reversed-phase or normal-phase mode. A stationary phase incorporating both polar and nonpolar functionality can be used in either reversed-phase or normal-phase mode.

Modes of Separation

Reversed-Phase Chromatography (RPC) is the most popular HPLC mode and is used in 60% – 80% of all applications. In RPC, hydrophobic groups (C18, C8, or C4) bonded to a silica support are used together with a mobile phase of water and organic solvent (e.g. methanol, acetonitrile).

Polar Phase (Normal Phase) Chromatography (NPC) uses a polar stationary phase (unbonded silica, bonded amino or cyano group) together with a non-polar mobile phase (e.g., hexane). NPC is useful for functional group analysis, isomeric separations, purification of organics, and sample cleanup.

Ion-Exchange Chromatography (IEC) utilizes bonded ionic groups to separate ionic analytes. Retention is based on the affinity of various analyte ions for the stationary phase and various mobile phase parameters (e.g., pH, ionic strength).

Column Hardware

Brownlee Conventional Columns

Brownlee Columns provide a wide range of options for HPLC analysis. Our conventional columns (non-cartridge) use standard compression end fittings compatible with all HPLC instrumentation. These columns do not require MPLC holders.

Features and Benefits

- End fittings compatible with HPLC systems from any vendor
- Use with NewGuard system (line connection) for even longer column life
- Each column is individually tested
- ISO-9001 certified process ensures the highest quality



Conventional columns do not require MPLC holders



Brownlee MPLC cartridges and holders



NewGuard cartridge coupled directly to 220 mm cartridge column

Brownlee Conventional Columns

Brownlee analytical and semi-prep scale cartridge columns are available in several phases, lengths and diameters. The Brownlee cartridge system holders are designed with finger-tight assembly for simplicity and the standard 1/16" o.d. capillary tubing fittings allow them to be used in virtually any manufacturers HPLC systems. Additionally the cartridge holder system can incorporate guard columns that are directly coupled to the analytical column for a zero dead volume connection. Specific column holders are required different column lengths but the analytical holders will work with both the 4.6 mm and 2.1 mm diameter cartridges. Column hardware, especially the end fittings, is a significant percentage of the cost in HPLC columns. With Brownlee cartridge holders the end fittings are reusable so the column cartridges are less expensive than conventional columns resulting in lower cost operation over the long term. The pressure rating on Brownlee cartridge holders are 7000 psi for silica based columns.

Features and Benefits

- **Quality:** Columns are manufactured under stringent ISO-9001 certified quality control standards. Individual test chromatograms are included with each cartridge > 30 mm length
- **Flexible:** Same reusable holder for 4.6 mm and 2.1 mm i.d. cartridges. Compatible with all HPLC instruments
- **Economical:** Cartridges are less expensive than conventional columns
- **Experience:** Over 35 years of manufacturing experience since Bob Brownlee introduced the first finger-tight cartridge system in 1977

Brownlee Conventional Column Options:

Brownlee Analytical

This is PerkinElmer's all-purpose HPLC column line for conventional as well as high speed LC separations. The (110 Å) silica is equivalent to the Hypersil. Columns are available in 3 or 5 μ and lengths ranging from 30 – 250mm, in 2.1 and 4.6 i.d. The Brownlee Analytical family includes Amino, Biphenyl, C18, C8, Cyano, Phenyl, Silica, and PAH phases.

Brownlee Analytical DB and HRes

These columns allow analysis of a range of compounds from small molecules to short peptides while the base deactivation makes these columns appropriate for the analysis of acidic to basic compounds. These (140 Å) silica columns are excellent replacements for Hypersil® BDS columns. Columns are available in 1.9, 3 or 5 μ .

Brownlee Aquapore® and Bio

This is a wide-pore (300 Å, 7, and 20 μ m), silica-based support suitable for the separation of large biomolecules such as peptides and proteins. Columns are available in 5 μ and lengths ranging from 30 – 250mm, in 2.1 and 4.6 i.d. in C8 and C18 phases.

Brownlee CHOICE™

This line of columns is made of (60 Å) silica which results in large surface area, high carbon loads, and high retention compounds. Columns are available in 3 or 5 μ and lengths ranging from 30 – 250 mm, in 2.1 and 4.6 i.d. The Brownlee CHOICE family includes the Basix, C18, Organic Acids, and PFP Propyl phases.

Brownlee Spheri-5®

This is a small-pore (80 Å, 5 μ m), silica based sorbent for separating small molecules. Both monofunctional (comb-pre) and polyfunctional (polymerized loop-type) C8 and C18 sorbents available.

Brownlee Validated™

These columns are made on high-purity, Type B silica with inherent low silanophilic activity. It exhibits excellent peak shape for a wide range of compounds while also having a wide number of phases. The Brownlee Validated columns are the best choice for pharmaceutical applications that deal with a lot of basic or multi-functional compounds. Columns are available in 3 or 5 μ and lengths ranging from 30 – 250mm, in 2.1 and 4.6 i.d., and include Amino, C18, C8, Carbamate, Cyano, IBD (intrinsically base-deactivated), PFP (pentafluorophenyl) and phenyl phases.

Guard Columns and Cartridges

To protect your column investment, we offer a complete line of guard columns in our direct connect guard cartridges. These can be attached to any column offered above. You can easily select the phase type to the appropriate guard column packing to ensure a correct silica match.

Brownlee Sorbents

Brownlee offers a wide selection of sorbents based on both silica and polymer supports.

Aquapore® is a wide-pore (300 Å, 7, and 20 μ m), silica-based support suitable for the separation of large biopolymers.

Spheri-5® is a small-pore (80 Å, 5 μ m), silica-based sorbent for separating small molecules. Both monofunctional (comb-type) and polyfunctional (polymerized loop-type) C8 and C18 sorbents are available.

Polypore® is a polymer-based (microporous, 10 μ m) sorbent for the analysis of organic acid and sugars.

Validated™ is a small-pore (100 Å, 5 μ m) silica-based C18 sorbent for small molecules, specifically for consistent pharmaceutical assays.

Pecosphere™ is a small-pore (80 Å, 3, 5, and 10 μ m) silica-based sorbent for HPLC of small molecules.

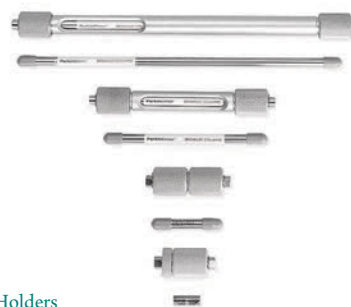

Brownlee
Columns and Holders

Reduced Activity is a small-pore, base-deactivated (100 Å, 3, and 5 μ m) silica-based, reversed-phase sorbent (C18 or C8) developed for HPLC of basic analytes and pharmaceuticals.

CHOICE™ is a small-pore, base-deactivated (100 Å, 3 μ m C18) silica-based, reversed-phase sorbent (C18) developed for LC/MS separations.

Brownlee Analytical Columns

Brownlee Analytical columns are built on 110 Å pore size Type A silica in 3 µm and 5 µm particle sizes that is equivalent to the classic Hypersil® silica. These columns provide excellent peak shape for acidic and neutral analytes but are generally not recommended for basic analytes. They are available in column lengths from 30 – 250 mm in 2.1 and 4.6 mm i.d. The Brownlee Analytical family includes classic phases like C18, C8, Phenyl, Cyano, Amino and bare Silica (HILIC) plus uniquely selective phases like Biphenyl and PAH.

Features and Benefits

- Type A, 110 Å pore size silica equivalent to classic Hypersil® silica
- Good choice when analyzing neutral and acidic analytes
- Available in classic phases and unique phases like biphenyl and PAH

Material Characteristics

| Phase* | Particle Sizes (µm) | Pore Size (Å) | Carbon Load | End Capping | pH Stability | Temp. Limit | USP Code |
|----------|---------------------|---------------|-------------|-------------|--------------|-------------|----------|
| C18 | 3.0, 5.0 | 110 | 13% | Yes | 2.5 – 7.5 | 80 °C | L1 |
| C8 | 5.0 | 110 | 7% | Yes | 2.5 – 7.5 | 80 °C | L7 |
| Cyano | 5.0 | 110 | 4% | Yes | 2.5 – 7.5 | 80 °C | L10 |
| Amino | 3.0, 5.0 | 110 | 2% | No | 2.5 – 7.5 | 80 °C | L8 |
| Phenyl | 5.0 | 110 | 6% | Yes | 2.5 – 7.5 | 80 °C | L11 |
| Biphenyl | 5.0 | 110 | * | Yes | 2.5 – 7.5 | 80 °C | L11 |
| PAH | 4.0 | 110 | * | Yes | 2.5 – 7.5 | 80 °C | |
| Silica | 5.0 | 110 | | No | 2.5 – 7.5 | 80 °C | L3 |

* Proprietary

Brownlee Analytical C18

Excellent choice for a general purpose C18 column with intermediate carbon loading and surface area. These columns provide reliable performance and excellent peak symmetry for a broad range of acidic and neutral hydrophobic compounds.

| Particle Size (µm) | Length (mm) | ID (mm) | Part No. |
|--------------------|-------------|---------|-----------------|
| 3.0 | 30 | 4.6 | N9303509 |
| 3.0 | 50 | 4.6 | N9303510 |
| 3.0 | 100 | 4.6 | N9303507 |
| 3.0 | 150 | 4.6 | N9303508 |
| 5.0 | 100 | 4.0 | N9303511 |
| 5.0 | 100 | 4.6 | N9303512 |
| 5.0 | 150 | 4.6 | N9303513 |
| 5.0 | 250 | 4.6 | N9303514 |

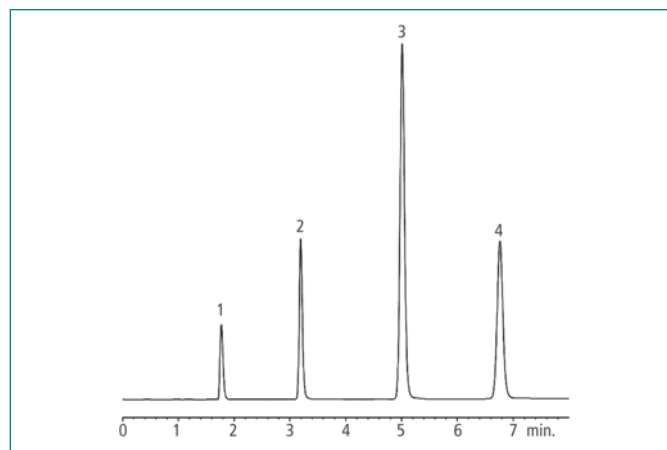

Column: Brownlee Analytical C18
Dimensions: 150 x 4.6 mm
Part Number: N9303508
Mobile Phase: 20:80, Water:Methanol
Flow Rate: 1.0 mL/min
Detector: UV @ 254 nm
Peak List:

1. Uracil
2. Benzene
3. Naphthalene
4. Biphenyl

CONVENTIONAL COLUMNS

Brownlee Analytical C8

Excellent choice for a general purpose C18 column with intermediate carbon loading and surface area. These columns provide reliable performance and excellent peak symmetry for a broad range of acidic and neutral hydrophobic compounds.

| Particle Size (µm) | Length (mm) | ID (mm) | Part No. |
|--------------------|-------------|---------|----------|
| 5.0 | 30 | 4.6 | N9303521 |
| 5.0 | 100 | 4.6 | N9303515 |
| 5.0 | 150 | 4.0 | N9303516 |
| 5.0 | 150 | 4.6 | N9303517 |
| 5.0 | 200 | 4.6 | N9303518 |
| 5.0 | 250 | 4.0 | N9303519 |
| 5.0 | 250 | 4.6 | N9303520 |

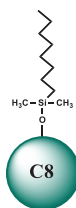

Brownlee Analytical Cyano

The Analytical Cyano is a traditional monomeric cyanopropylsilane stationary phase that can be used in normal-phase, reverse-phase and HILIC modes. Use mobile phase pH between 5 and 7 for the best performance in reverse-phase mode. The cyano phase is often considered to have orthogonal selectivity to C8 & C18 that can be used for confirmatory analysis. Suitable for analysis of a wide range of compounds from acidic to slightly basic and is an excellent choice for analysis of protonated bases.

| Particle Size (µm) | Length (mm) | ID (mm) | Part No. |
|--------------------|-------------|---------|----------|
| 5.0 | 150 | 4.6 | N9303522 |
| 5.0 | 200 | 4.6 | N9303523 |

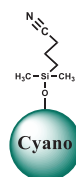

Brownlee Analytical Amino

The Analytical Amino is a normal-phase, monomeric aminopropylsilane stationary phase that is popular for routine sugar analysis. This phase is suitable for mono- and disaccharide analysis using a refractive index (RI) or evaporative light scattering detector (ELSD). Isocratic elution (e.g., 75:25, acetonitrile:water) must be used with an RI detector but gradient elution can be utilized for higher efficiency separations when using an ELSD or MS detector.

| Particle Size (µm) | Length (mm) | ID (mm) | Part No. |
|--------------------|-------------|---------|----------|
| 3.0 | 50 | 4.6 | N9303502 |
| 3.0 | 100 | 4.6 | N9303500 |
| 3.0 | 150 | 4.6 | N9303501 |
| 5.0 | 50 | 4.6 | N9303506 |
| 5.0 | 100 | 4.6 | N9303503 |
| 5.0 | 150 | 4.6 | N9303504 |
| 5.0 | 250 | 4.6 | N9303505 |

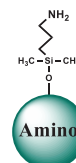

Brownlee Analytical Phenyl

The Analytical Phenyl offer alternative selectivity to the traditional straight alkyl chain phases, especially for aromatic compounds due to *pi-pi* interactions with the phenyl phase.

| Particle Size (µm) | Length (mm) | ID (mm) | Part No. |
|--------------------|-------------|---------|----------|
| 5.0 | 150 | 4.6 | N9303524 |

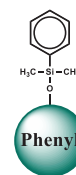

Brownlee Analytical Biphenyl

The Analytical Biphenyl is a unique phase that offers more dispersive (Van Der Waals) interactions and a higher degree of polarizability than the phenyl phase. With the higher degree of dispersive and polar interactions, this column exhibits increased retention for dipolar, unsaturated and conjugated analytes. It also exhibits enhanced selectivity when using methanolic mobile phases.

| Particle Size (µm) | Length (mm) | ID (mm) | Part No. |
|--------------------|-------------|---------|----------|
| 5.0 | 150 | 4.6 | N9303931 |
| 5.0 | 200 | 4.6 | N9303932 |

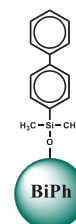

Brownlee Analytical Silica

Analytical silica columns are simply bare silica particles for use in normal phase separations recommended for analysis of highly polar compounds.

| Particle Size (µm) | Length (mm) | ID (mm) | Part No. |
|--------------------|-------------|---------|-----------------|
| 5.0 | 150 | 4.6 | N9303525 |
| 5.0 | 200 | 4.6 | N9303526 |



Brownlee Analytical PAH

The Analytical PAH column was specifically developed for the analysis of polycyclic aromatic hydrocarbons. The PAH stationary phase incorporates a proprietary specially bonded C18 that is shape selective that results in baseline resolution of all 16 priority PAHs in US EPA Method 610. Each lot of Analytical PAH material is tested to ensure baseline resolution all 16 PAHs.

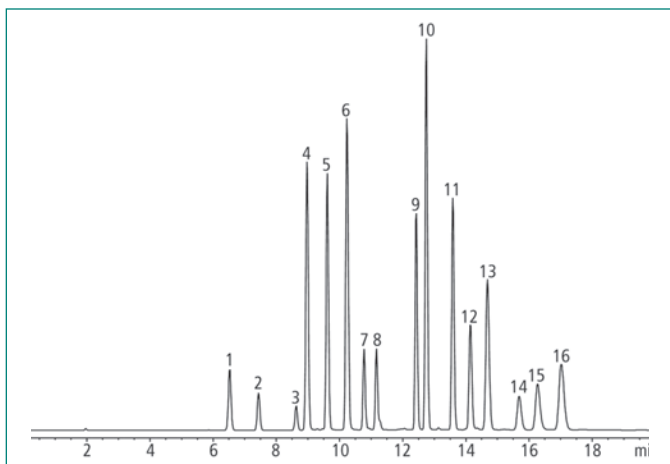

Peak List Concentration (µg/mL)

- | | |
|-------------------|------------------------------|
| 1. naphthalene | 9. benzo (a) anthracene |
| 2. acenaphthylene | 10. chrysene |
| 3. acenaphthene | 11. benzo (b) fluoranthene |
| 4. fluorene | 12. benzo (k) fluoranthene |
| 5. phenanthrene | 13. benzo (a) pyrene |
| 6. anthracene | 14. dibenzo (a,h) anthracene |
| 7. fluoranthene | 15. benzo (ghi) perylene |
| 8. pyrene | 16. indeno (1,2,3-cd) pyrene |

| Particle Size (µm) | Length (mm) | ID (mm) | Part No. |
|--------------------|-------------|---------|-----------------|
| 4.0 | 100 | 4.6 | N9303527 |
| 4.0 | 150 | 3.2 | N9303430 |
| 4.0 | 150 | 4.6 | N9303529 |
| 4.0 | 200 | 4.6 | N9303528 |
| 4.0 | 250 | 2.1 | N9303530 |
| 4.0 | 250 | 4.6 | N9303531 |

Brownlee Analytical DB Columns for HPLC and UHPLC

Brownlee Analytical DB columns are moderately retentive HPLC and sub-2 μm UHPLC columns built on a foundation of high purity, base-deactivated silica that is optimized for UHPLC performance. These columns are available in 3 & 5 μm HPLC particle sizes, as well as a 1.9 μm UHPLC particle size. The silica manufacturing and phase bonding processes are identical for all particle sizes in this series resulting in method scalability from HPLC (3 & 5 μm) to UHPLC (1.9 μm), or vice versa. In addition the larger 140 Å pore size allows analysis of a range of compounds from small molecules to short peptides while the base deactivation makes these columns appropriate for the analysis of acidic, neutral and basic compounds. These columns are excellent replacements for Hypersil® BDS columns.

Features and Benefits

- Conventional and sub-2 μm particles sizes for HPLC and UHPLC systems
- Base-deactivated silica optimized for UHPLC performance from acidic to basic analytes
- All silica prepared by the same process for true HPLC to UHPLC method scalability

Increase efficiency and shorten run times while maintaining selectivity with 1.9 μm Brownlee Analytical DB UHPLC columns

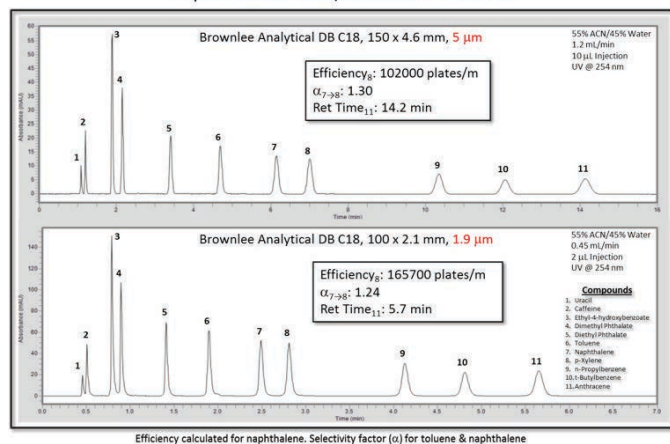

Material Characteristics

| Phase* | Particle Sizes (μm) | Pore Size (Å) | Carbon Load | End Capping | pH Stability | Temp. Limit | USP Code |
|------------|----------------------------------|---------------|-------------|-------------|--------------|-------------|----------|
| C18 | 1.9, 3.0, 5.0 | 140 | 11% | Yes | 2.5 – 8.0 | 80 °C | L1 |
| Aq C18 | 1.9, 3.0, 5.0 | 140 | 6% | * | 2.5 – 8.0 | 80 °C | L1 |
| IBD | 1.9 | 140 | * | Yes | 2.5 – 8.0 | 80 °C | L68 |
| Cyano | 1.9, 5.0 | 140 | 4% | No | 2.5 – 8.0 | 80 °C | L10 |
| Biphenyl | 1.9, 3.0, 5.0 | 140 | 8% | Yes | 2.5 – 8.0 | 80 °C | L11 |
| PFP Propyl | 1.9, 3.0, 5.0 | 140 | 6% | Yes | 2.5 – 8.0 | 80 °C | L43 |
| Silica | 1.9 | 140 | | No | 2.5 – 8.0 | 80 °C | L3 |
| PAH | 1.9 | 140 | * | Yes | 2.5 – 8.0 | 80 °C | |

* Proprietary

Brownlee Analytical DB C18

C18 is a good general purpose phase for the analysis of compounds ranging from acid to slightly basic. This is an excellent replacement for very basic compounds. They will have excellent peak shape on these columns with the addition of ion pairing agents to the mobile phase.

| Particle Size (μm) | Length (mm) | ID (mm) | Part No. |
|---------------------------------|-------------|---------|----------|
| 1.9 | 30 | 2.1 | N9303911 |
| 1.9 | 50 | 2.1 | N9303912 |
| 1.9 | 100 | 2.1 | N9303913 |
| 3.0 | 30 | 4.6 | N9303887 |
| 3.0 | 50 | 4.6 | N9303888 |
| 3.0 | 100 | 4.6 | N9303889 |
| 5.0 | 50 | 4.6 | N9303890 |
| 5.0 | 150 | 4.6 | N9303891 |
| 5.0 | 250 | 4.6 | N9303892 |



Brownlee Analytical DB Aqueous C18

The Aqueous C18 contains a proprietary polar side chain functionally bonded C18 that provides a more well balanced retention profile for both polar and non-polar compounds than a traditional C18. This column can be used with a gradient to retain polar compounds that elute near the void time on a standard C18. The Aqueous C18 provides both high reproducibility and compatibility with a wide variety of mobile phases including 100% aqueous mobile phases.

| Particle Size (μm) | Length (mm) | ID (mm) | Part No. |
|---------------------------------|-------------|---------|----------|
| 1.9 | 30 | 2.1 | N9303917 |
| 1.9 | 50 | 2.1 | N9303918 |
| 1.9 | 100 | 2.1 | N9303919 |
| 3.0 | 30 | 4.6 | N9303903 |
| 3.0 | 50 | 4.6 | N9303904 |
| 3.0 | 100 | 4.6 | N9303905 |
| 5.0 | 50 | 4.6 | N9303906 |
| 5.0 | 150 | 4.6 | N9303907 |
| 5.0 | 250 | 4.6 | N9303908 |

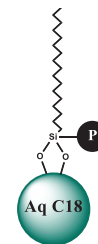

Brownlee Analytical DB IBD

The IBD (intrinsically base-deactivated) is an alkyl phase with a proprietary polar group embedded in the hydrocarbon chain. This phase provides unique retention and selectivity for acidic compounds while the base-deactivation gives symmetrical peak shapes for strong bases that results in one of the most versatile phases available. The IBD can be used in reverse phase mode and is compatible with 100% aqueous mobile phase or in HILIC mode with highly organic mobile phases for improved retention of polar ionic compounds.

| Particle Size (µm) | Length (mm) | ID (mm) | Part No. |
|--------------------|-------------|---------|----------|
| 1.9 | 30 | 2.1 | N9303920 |
| 1.9 | 50 | 2.1 | N9303921 |
| 1.9 | 100 | 2.1 | N9303922 |



Brownlee Analytical DB Biphenyl

The Analytical Phenyl offers alternative selectivity to the traditional straight alkyl chain phases, especially for aromatic compounds due to *pi-pi* interactions with the phenyl phase.

| Particle Size (µm) | Length (mm) | ID (mm) | Part No. |
|--------------------|-------------|---------|----------|
| 1.9 | 30 | 2.1 | N9303911 |
| 1.9 | 50 | 2.1 | N9303912 |
| 1.9 | 100 | 2.1 | N9303913 |
| 3.0 | 30 | 4.6 | N9303887 |
| 3.0 | 50 | 4.6 | N9303888 |
| 3.0 | 100 | 4.6 | N9303889 |
| 5.0 | 50 | 4.6 | N9303890 |
| 5.0 | 150 | 4.6 | N9303891 |
| 5.0 | 250 | 4.6 | N9303892 |

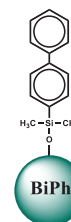

Brownlee Analytical DB Cyano

The Analytical DB and HRes Cyano is a traditional monomeric cyanopropylsilane stationary phase that can be used in normal-phase, reverse-phase and HILIC modes. Use mobile phase pH between 5 and 7 for the best performance in reverse-phase mode. Suitable for analysis of a wide range of compounds from acidic to basic. It is an excellent choice for analysis of protonated bases.

| Particle Size (µm) | Length (mm) | ID (mm) | Part No. |
|--------------------|-------------|---------|----------|
| 1.9 | 30 | 2.1 | N9303973 |
| 1.9 | 50 | 2.1 | N9303974 |
| 1.9 | 100 | 2.1 | N9303975 |
| 5.0 | 50 | 4.6 | N9303869 |
| 5.0 | 150 | 4.6 | N9303870 |
| 5.0 | 250 | 4.6 | N9303871 |

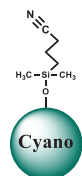

CONVENTIONAL COLUMNS

Brownlee Analytical DB PFP Propyl

The Pentafluorophenyl Propyl phase is uniquely selective for compounds containing basic functional groups and organohalogens. Unlike the cyano phases, PFP Propyl is a better choice for LC/MS analysis because it is reliable and efficient with acidic mobile phases like formic acid and it is very versatile because it can be used with highly aqueous mobile phases as well as HILIC separations. These columns are recommended for the analysis of nucleotides, nucleosides, pyrimidines, purines and halogenated compounds.

| Particle Size (µm) | Length (mm) | ID (mm) | Part No. |
|--------------------|-------------|---------|----------|
| 1.9 | 30 | 2.1 | N9303914 |
| 1.9 | 50 | 2.1 | N9303915 |
| 1.9 | 100 | 2.1 | N9303916 |
| 3.0 | 30 | 4.6 | N9303895 |
| 3.0 | 50 | 4.6 | N9303896 |
| 3.0 | 100 | 4.6 | N9303897 |
| 5.0 | 50 | 4.6 | N9303898 |
| 5.0 | 150 | 4.6 | N9303899 |
| 5.0 | 250 | 4.6 | N9303900 |

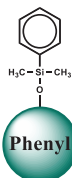

Brownlee Analytical DB PAH

The Analytical HRes PAH column was specifically developed for fast analysis of polycyclic aromatic hydrocarbons. The PAH stationary phase incorporates a proprietary specially bonded C18 that is shape selective that results in baseline resolution of all 16 priority PAHs in US EPA Method 610. The Analytical HRes PAH is capable of separating all 16 PAHs in under 18 minutes with a simple acetonitrile/water gradient.

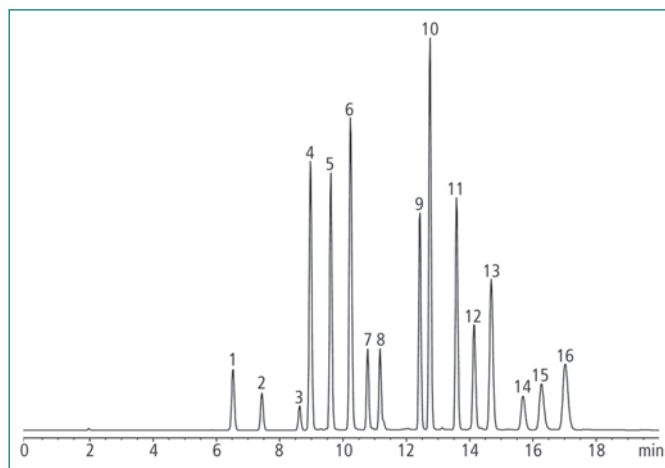

| Peak List | Concentration (µg/mL) | | |
|-------------------|-----------------------|------------------------------|----|
| 1. naphthalene | 100 | 9. benzo (a) anthracene | 50 |
| 2. acenaphthylene | 100 | 10. chrysene | 50 |
| 3. acenaphthene | 100 | 11. benzo (b) fluoranthene | 50 |
| 4. fluorene | 100 | 12. benzo (k) fluoranthene | 50 |
| 5. phenanthrene | 50 | 13. benzo (a) pyrene | 50 |
| 6. anthracene | 100 | 14. dibenzo (a,h) anthracene | 50 |
| 7. fluoranthene | 50 | 15. benzo (ghi) perylene | 50 |
| 8. pyrene | 50 | 16. indeno (1,2,3-cd) pyrene | 50 |

Brownlee Analytical DB Silica

Analytical HRes silica columns are simply bare silica particles for use in normal phase separations recommended for fast analysis of highly polar compounds.

| Particle Size (µm) | Length (mm) | ID (mm) | Part No. |
|--------------------|-------------|---------|----------|
| 1.9 | 30 | 2.1 | N9303970 |
| 1.9 | 50 | 2.1 | N9303971 |
| 1.9 | 100 | 2.1 | N9303972 |
| 5.0 | 50 | 4.6 | N9303879 |
| 5.0 | 150 | 4.6 | N9303880 |
| 5.0 | 250 | 4.6 | N9303981 |

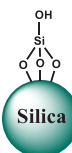

| Particle Size (µm) | Length (mm) | ID (mm) | Part No. |
|--------------------|-------------|---------|----------|
| 1.9 | 50 | 2.1 | N9303995 |
| 1.9 | 100 | 2.1 | N9303996 |

Brownlee Aquapore and Bio Columns

Brownlee Aquapore and Bio columns are built on large pore silica for the analysis of large biomolecules such as peptides and proteins. Large pore stationary phases are required for the analysis of large molecules because the analytes need to penetrate the pores to improve retention and resolution. The Aquapore columns are based on 7 µm silica while the Bio columns are based on 5 µm silica for increased plate counts.

Features and Benefits

- Rugged, spherical silica particles with 300 Å pore size
- Excellent choice for separation of peptides, proteins and other large molecules

Material Characteristics

| Phase* | Particle Sizes (µm) | Pore Size (Å) | Carbon Load | End Capping | pH Stability | Temp. Limit | USP Code |
|-----------------|---------------------|---------------|-------------|-------------|--------------|-------------|----------|
| AP OD-300 (C18) | 7.0 | 300 | 10% | Yes | 2.5 – 8.0 | 60 °C | L1 |
| AP RP-300 (C8) | 7.0 | 300 | 5% | Yes | 2.5 – 8.0 | 60 °C | L7 |
| AP AX-300† | 7.0 | 300 | | | 2.0 – 8.0 | 60 °C | |
| AP CX-300‡ | 7.0 | 300 | | | 2.0 – 8.0 | 60 °C | |
| Bio C18 | 5.0 | 300 | 9% | Yes | 2.5 – 8.0 | 80 °C | L1 |
| Bio C8 | 5.0 | 300 | 5% | Yes | 2.5 – 8.0 | 80 °C | L7 |

* AP = Aquapore; † AX = Weak Anion Exchange; ‡ CX = Weak Cation Exchange

Brownlee Aquapore 7 µm Columns

Brownlee Aquapore conventional columns built on a 7 µm, 300 Å pore size silica. The OD-300 and RP-300 are reverse-phase silicas modified with C18 and C8, respectively. AX-300 is a weak anion exchanger that is composed of a crosslinked polyethyleneimine phase bonded on the silica surface. CX-300 is a weak cation exchanger that is composed of a polyamide coating containing carboxymethyl groups phase bonded on the silica surface. The reverse-phase columns are also available in microbore (1.0 mm i.d) for increased sensitivity and better compatibility with LC/MS interfaces.

| ID (mm) | Length (mm) | OD-300 (C18) Part No. | RP-300 (C8) Part No. | AX-300 Part No. | CX-300 Part No. |
|---------|-------------|--------------------------|-------------------------|--------------------|--------------------|
| 1.0 | 50 | | 07120070 | | |
| 1.0 | 100 | 07120099 | 07120096 | | |
| 1.0 | 250 | | 07120097 | | |
| 2.1 | 30 | 07110234 | 07110056* | 07110074 | |
| 2.1 | 100 | 07110233 | 07110058 | 07110076 | |
| 2.1 | 220 | 07110236 | 07110060 | | |
| 4.6 | 30 | 07110235 | 07110055 | 07110073 | |
| 4.6 | 100 | 07110232 | 07110057 | 07110075 | |
| 4.6 | 220 | 07110231 | 07110059 | 07110077 | |
| 4.6 | 250 | 07120073 | 07120033 | 07120040 | 07120043 |

Brownlee Bio 5 µm Columns

Brownlee Bio C18 and C8 are reverse-phase columns built on a 5 µm particle size, 300 Å pore size silica. The C8 should be used for very hydrophobic analytes because it is less retentive than the C18. They are available in lengths from 50 to 250 mm lengths in 4.6 and 2.1 mm i.d.

| Length (mm) | C18 | | C8 | |
|-------------|-----------------------|-----------------------|-----------------------|-----------------------|
| | 2.1 mm ID Part No. | 4.6 mm ID Part No. | 2.1 mm ID Part No. | 4.6 mm ID Part No. |
| 50 | N9303654 | N9303655 | N9303664 | N9303665 |
| 100 | N9303646 | N9303647 | N9303656 | N9303657 |
| 150 | N9303648 | N9303649 | N9303658 | N9303659 |
| 200 | N9303650 | N9303651 | N9303660 | N9303661 |
| 250 | N9303652 | N9303653 | N9303662 | N9303663 |

Brownlee CHOICE Columns

Brownlee CHOICE HPLC columns are packed with 60 Å pore size, high purity Type B silica with high surface area allowing for dense ligand bonding, high carbon load stationary phases. This results in our most retentive stationary phases which require stronger organic mobile phases. Although these columns can be used with any HPLC system, the high organic mobile phases required for elution make these columns an excellent choice when using MS and ELSD detectors which require efficient mobile phase evaporation for optimum sensitivity. CHOICE columns are available in a 5 µm particle size, 30 – 250 mm column lengths, 4.6 and 2.1 mm ID. The 2.1 mm ID columns are the best fit for MS and ELSD since they require lower flow rates for efficient performance.

Features and Benefits

- Highly retentive, small pore (60 Å), high carbon load columns built on high purity Type B silica
- Require stronger organic mobile phase than any other Brownlee columns
- An excellent Choice for MS and ELSD detectors

Material Characteristics

| Phase* | Particle Sizes (µm) | Pore Size (Å) | Carbon Load | End Capping | pH Stability | Temp. Limit | USP Code |
|---------------|---------------------|---------------|-------------|-------------|--------------|-------------|----------|
| C18 | 5.0 | 60 | 27% | Yes | 2.5 – 8.0 | 80 °C | L1 |
| Aq C18 | 5.0 | 60 | * | No | 2.5 – 8.0 | 80 °C | L1 |
| Basix | 5.0 | 60 | 12% | Yes | 2.5 – 8.0 | 80 °C | L10 |
| Biphenyl | 5.0 | 60 | 23% | No | 2.5 – 8.0 | 80 °C | L11 |
| PFP Propyl | 3.0, 5.0 | 60 | 17% | Yes | 2.5 – 8.0 | 80 °C | L43 |
| Organic Acids | 5.0 | 60 | * | Yes | 2.5 – 8.0 | 80 °C | |
| AK | 5.0 | 60 | * | No | 2.5 – 8.0 | 80 °C | |

* Proprietary

Pesticides on Brownlee Choice C18

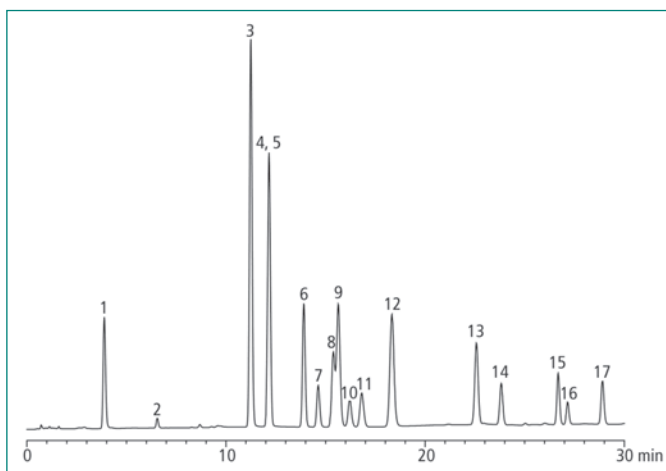

Peak List

- | | |
|----------------------------|--------------------|
| 1. desisopropyl atrazine | 9. secbumeton |
| 2. desethyl atrazine | 10. isoproturon |
| 3. simazine | 11. diuron |
| 4. terbuthylazine desethyl | 12. terbumeton |
| 5. cyanazine | 13. terbuthylazine |
| 6. methabenzthiazuron | 14. linuron |
| 7. chlortoluron | 15. flusilazole |
| 8. atrazine | 16. ethofumesate |
| | 17. neburon |

Brownlee Choice C18

The Choice C18 is the most retentive alkyl phase in our product line. The high density bonding and high carbon load of this phase is made possible by the high surface area of the base silica. These end-capped columns provide excellent peak shapes for a wide range of analytes.

| Particle Size (µm) | Length (mm) | ID (mm) | Part No. |
|--------------------|-------------|---------|----------|
| 5.0 | 50 | 2.1 | N9303626 |
| 5.0 | 100 | 2.1 | N9303625 |
| 5.0 | 150 | 2.1 | N9303627 |
| 5.0 | 250 | 2.1 | N9303629 |
| 5.0 | 150 | 4.6 | N9303628 |
| 5.0 | 250 | 4.6 | N9303630 |



Brownlee Choice Aqueous C18

This is a polar embedded C18 that has improved retention and selectivity for polar analytes compared to the standard C18. This phase is highly base deactivated to improve peak shape by reducing silanol activity and can be operated with a 100% aqueous mobile phase. This is an excellent choice for the analysis of a wide variety of compounds by LC/MS screening.

| Particle Size (µm) | Length (mm) | ID (mm) | Part No. |
|--------------------|-------------|---------|----------|
| 5.0 | 50 | 4.6 | N9303935 |
| 5.0 | 150 | 4.6 | N9303936 |
| 5.0 | 250 | 4.6 | N9303937 |

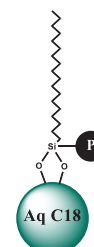

Brownlee Choice Basix

This is a highly retentive phenyl cyano phase especially suited for the separation of basic compounds containing amines.

| Particle Size (µm) | Length (mm) | ID (mm) | Part No. |
|--------------------|-------------|---------|-----------------|
| 5.0 | 50 | 2.1 | N9303615 |
| 5.0 | 100 | 2.1 | N9303613 |
| 5.0 | 150 | 2.1 | N9303617 |
| 5.0 | 50 | 4.6 | N9303616 |
| 5.0 | 100 | 4.6 | N9303614 |
| 5.0 | 150 | 4.6 | N9303618 |
| 5.0 | 250 | 4.6 | N9303619 |

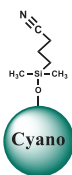

Brownlee Choice Organic Acids

The Choice Organic Acids columns are uniquely designed for enhanced retention and selectivity to resolve organic acids in food such as tartaric and quinic acids on a single 30 cm column using the conditions specified in AOAC method 986.13. Retentions times are very stable on this column even using 100% aqueous mobile phase.

| Particle Size (µm) | Length (mm) | ID (mm) | Part No. |
|--------------------|-------------|---------|-----------------|
| 5.0 | 250 | 2.1 | N9303632 |
| 5.0 | 150 | 4.6 | N9303631 |
| 5.0 | 250 | 4.6 | N9303633 |
| 5.0 | 300 | 4.6 | N9303634 |

Brownlee Choice Biphenyl

This is a highly retentive phase for aromatic and unsaturated compounds with improved selectivity when compared to standard phenyl phases. This phase is an excellent choice for separation of unsaturated compounds such as steroids, tetracyclines and explosives.

| Particle Size (µm) | Length (mm) | ID (mm) | Part No. |
|--------------------|-------------|---------|-----------------|
| 5.0 | 50 | 4.6 | N9303940 |
| 5.0 | 100 | 4.6 | N9303941 |
| 5.0 | 150 | 4.6 | N9303942 |

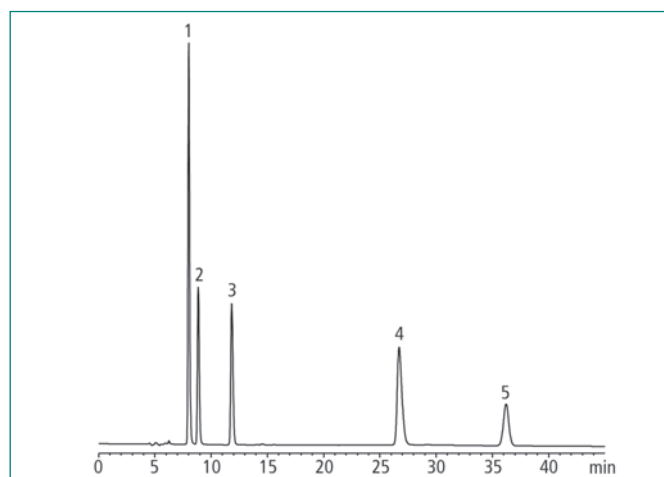
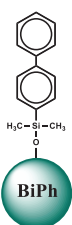

Peak List

1. tartaric acid
2. quinic acid
3. malic acid
4. citric acid
5. fumaric acid

Brownlee Choice PFP Propyl

A phase of pentafluorophenyl with a propyl spacer that is highly retentive for basic analytes, this phase is ideal for the separation of basic drugs prior to MS detection. This bonded phase has been shown to efficiently separate basic drugs in a 90% acetonitrile/water mobile phase, eliminating the need for ion-pairing reagents and ion-suppressing reagents normally used for these separations on C18. This phase is well suited for the separation of tricyclic antidepressants, halogenated compounds and beta-blockers as well as nucleotides, nucleosides, pyrimidines and purines.

| Particle Size (µm) | Length (mm) | ID (mm) | Part No. |
|--------------------|-------------|---------|-----------------|
| 3.0 | 50 | 2.1 | N9303635 |
| 3.0 | 50 | 4.6 | N9303636 |
| 3.0 | 100 | 4.6 | N9303637 |
| 5.0 | 30 | 2.1 | N9303640 |
| 5.0 | 50 | 2.1 | N9303641 |
| 5.0 | 100 | 2.1 | N9303638 |
| 5.0 | 150 | 2.1 | N9303643 |
| 5.0 | 50 | 4.6 | N9303642 |
| 5.0 | 100 | 4.6 | N9303639 |
| 5.0 | 150 | 4.6 | N9303644 |
| 5.0 | 250 | 4.6 | N9303645 |

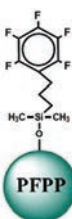

Brownlee Choice AK

The Choice AK column is specifically designed for the separation of DNHP derivatized aldehydes and ketones for environmental methods such as US EPA TO-11 and the California Air Resources Board (CARB) Method 1004. This column is specifically designed to separate the thirteen carbonyl compounds specified in CARB 1004 in under 15 minutes using a simple acetonitrile/water gradient.

| Particle Size (µm) | Length (mm) | ID (mm) | Part No. |
|--------------------|-------------|---------|-----------------|
| 5.0 | 200 | 3.2 | N9303884 |
| 5.0 | 200 | 4.6 | N9303885 |

Brownlee Validated Columns

Brownlee Validated HPLC columns are built on high purity, Type B silica with inherently low silanol activity and very consistent performance from lot-to-lot. This series of columns represent the most choices of stationary phases of any of the column lines offered by PerkinElmer. These columns exhibit excellent peak shapes for a wide range of compounds and are the best choice for pharmaceutical applications that deal with many basic and multi-functional compounds. Choice columns are available in a 3 and 5 μm particle sizes, 30 – 250 mm column lengths in 4.6 and 2.1 mm ID.

Features and Benefits

- Built on high purity, Type B silica for excellent peak shape for a wide range of compounds
- Available in the most choices in stationary phases
- Recommended for pharmaceutical applications with basic and multi-functional compounds

Material Characteristics

| Phase | Particle Sizes (μm) | Pore Size (\AA) | Carbon Load | End Capping | pH Stability | Temp. Limit | USP Code |
|------------|----------------------------------|----------------------------|-------------|-------------|--------------|-------------|----------|
| C1 | 5.0 | 100 | 5% | | 2.5 – 8.0 | 80 °C | L13 |
| C4 | 5.0 | 100 | 9% | Yes | 2.5 – 8.0 | 80 °C | L26 |
| C8 | 5.0,0 | 100 | 12% | Yes | 2.5 – 8.0 | 80 °C | L7 |
| C18 | 3.0, 5.0 | 100 | 20% | Yes | 2.5 – 8.0 | 80 °C | L1 |
| Aq C18 | 3.0, 5.0 | 100 | 15% | No | 2.5 – 8.0 | 80 °C | L1 |
| IBD | 3.0, 5.0 | 100 | 12% | No | 2.5 – 8.0 | 80 °C | L68 |
| PFP Propyl | 5.0 | 100 | 11% | Yes | 2.5 – 8.0 | 80 °C | L43 |
| Phenyl | 3.0, 5.0 | 100 | 10% | Yes | 2.5 – 8.0 | 80 °C | L11 |
| Cyano | 5.0 | 100 | 8% | Yes | 2.5 – 8.0 | 80 °C | L10 |
| Amino | 3.0, 5.0 | 100 | 2% | No | 2.5 – 8.0 | 80 °C | L8 |
| Carbamate | 3.0, 5.0 | 100 | * | * | 2.5 – 8.0 | 80 °C | |
| Quat | 5.0 | 100 | * | * | 2.5 – 8.0 | 80 °C | |

* Proprietary

Acetaminophen and Narcotic Analgesics on Brownlee Validated C18

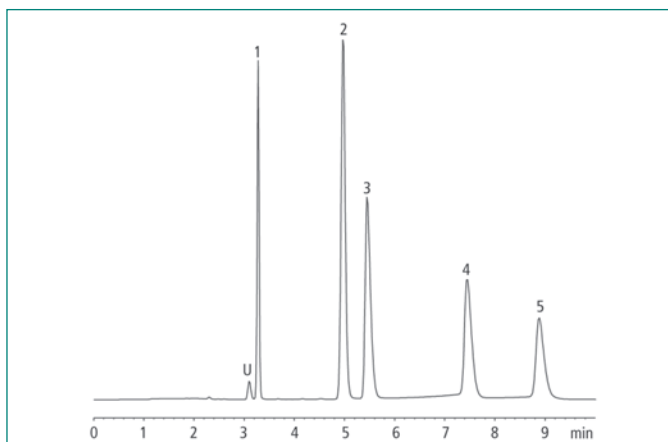

Peak List

1. morphine sulfate
2. acetaminophen
3. codeine phosphate
4. oxycodone HCL
5. hydrocodone bitartrate

Recommended Guard Cartridge N9303694
Recommended Guard Holder N9303713

Brownlee Validated C1

The Validated C1 is an exceptionally stable C1 phase. This is the least retentive reversed-phase packing.

| Particle Size (μm) | Length (mm) | ID (mm) | Part No. |
|---------------------------------|-------------|---------|----------|
| 5.0 | 150 | 4.6 | N9303718 |
| 5.0 | 250 | 4.6 | N9303719 |

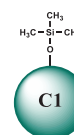

Brownlee Validated C4

The Validated C4 is exceptionally stable packing that is base deactivated with a high bonding coverage. C4 is a less retentive reverse-phase than C8 or C18.

| Particle Size (μm) | Length (mm) | ID (mm) | Part No. |
|---------------------------------|-------------|---------|----------|
| 3.0 | 150 | 4.6 | N9303851 |
| 5.0 | 150 | 4.6 | N9303720 |
| 5.0 | 250 | 4.6 | N9303721 |

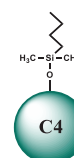

Brownlee Validated C8

The Validated C8 is a reverse-phase alkyl that provide less hydrophobic retention but better peak shape for basic compounds than a traditional C18. Like C18, C8 is a good general purpose reverse phase that is suitable for a wide range of compounds from acidic to slightly basic.

| Particle Size (µm) | Length (mm) | ID (mm) | Part No. |
|--------------------|-------------|---------|-----------------|
| 5.0 | 100 | 2.1 | N9303564 |
| 5.0 | 150 | 2.1 | N9303566 |
| 5.0 | 150 | 4.0 | N9303848 |
| 5.0 | 100 | 4.6 | N9303565 |
| 5.0 | 150 | 4.6 | N9303567 |
| 5.0 | 250 | 4.6 | N9303568 |

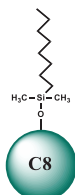

Brownlee Validated C18

The Validated C18 is a good general purpose reverse-phase column with moderate to high retention for hydrophobic compounds. The high purity, Type B silica has low silanol activity resulting in excellent peak shapes even for basic analytes. This phase is more retentive than C8 and recommended for a wide range of analytes from acidic to slightly basic.

| Particle Size (µm) | Length (mm) | 2.1 mm ID | | 4.6 mm ID | |
|--------------------|-------------|-----------------|----------|-----------------|----------|
| | | Part No. | Part No. | Part No. | Part No. |
| 3.0 | 100 | N9303551 | | N9303552 | |
| 5.0 | 50 | N9303562 | | N9303563 | |
| 5.0 | 100 | N9303553 | | N9303554 | |
| 5.0 | 150 | N9303557 | | N9303558 | |
| 5.0 | 200 | | | N9303559 | |
| 5.0 | 250 | N9303560 | | N9303561 | |



Brownlee Validated Aqueous C18

The Aqueous C18 contains a proprietary polar side chain functionally bonded C18 that provides a more well balanced retention profile for both polar and non-polar compounds than a traditional C18. This column can be used with a gradient to retain polar compounds that elute near the void time on a standard C18. The Aqueous C18 provides both high reproducibility and compatibility with a wide variety of mobile phases including 100% aqueous mobile phases. This is an excellent choice for the analysis of a wide variety of compounds by LC/MS screening.

| Particle Size (µm) | Length (mm) | 2.1 mm ID | | 4.6 mm ID | |
|--------------------|-------------|-----------------|----------|-----------------|----------|
| | | Part No. | Part No. | Part No. | Part No. |
| 3.0 | 30 | N9303540 | | | |
| 3.0 | 50 | N9303541 | | N9303542 | |
| 3.0 | 100 | N9303537 | | N9303538 | |
| 3.0 | 150 | N9303539 | | | |
| 5.0 | 30 | | | N9303550 | |
| 5.0 | 100 | N9303543 | | N9303544 | |
| 5.0 | 150 | N9303545 | | N9303546 | |
| 5.0 | 200 | | | N9303547 | |
| 5.0 | 250 | N9303548 | | N9303549 | |

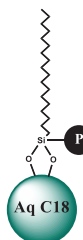

Brownlee Validated PFP Propyl

The pentafluorophenyl propyl phase is a great choice for retention and selectivity of charged bases, amine containing compounds and electronegative compounds. Unlike the cyano phases, PFP Propyl is a better choice for LC/MS analysis because it is reliable and efficient with acidic mobile phases like formic acid and it is very versatile because it can be used with highly aqueous mobile phases as well as HILIC separations. These columns are recommended for the analysis of nucleotides, nucleosides, pyrimidines, purines and halogenated compounds.

| Particle Size (µm) | Length (mm) | 2.1 mm ID Part No. | 4.6 mm ID Part No. |
|--------------------|-------------|--------------------|--------------------|
| 5.0 | 50 | N9303601 | |
| 5.0 | 100 | N9303598 | |
| 5.0 | 150 | | N9303598 |
| 5.0 | 150 | | N9303599 |
| 5.0 | 250 | | N9303600 |

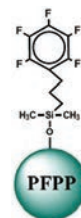

Brownlee Validated Phenyl

The Validated Phenyl is a high-purity, highly retentive, base-deactivated phase with alternate selectivity to straight chain hydrocarbon phases, especially for aromatic compounds.

| Particle Size (µm) | Length (mm) | 2.1 mm ID Part No. | 4.6 mm ID Part No. |
|--------------------|-------------|--------------------|--------------------|
| 3.0 | 30 | N9303604 | |
| 3.0 | 50 | N9303602 | N9303603 |
| 5.0 | 100 | N9303605 | N9303606 |
| 5.0 | 150 | | N9303607 |

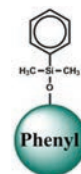

* N9303604 actual size is 100mm x 1.0mm

Brownlee Validated Cyano

The Validated Cyano is a traditional monomeric cyanopropylsilane stationary phase that can be used in normal-phase, reverse-phase and HILIC modes. Use mobile phase pH between 5 and 7 for the best performance in reverse-phase mode. Suitable for analysis of a wide range of compounds from acidic to basic, it is an excellent choice for analysis of protonated bases.

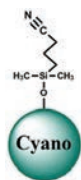

| Particle Size (µm) | Length (mm) | 2.1 mm ID Part No. | 4.6 mm ID Part No. |
|--------------------|-------------|--------------------|--------------------|
| 5.0 | 30 | | N9303578 |
| 5.0 | 100 | N9303572 | N9303573 |
| 5.0 | 150 | N9303574 | N9303575 |
| 5.0 | 220 | | N9303576 |
| 5.0 | 250 | | N9303577 |

Brownlee Validated Amino

The Validated Amino is a normal-phase, monomeric aminopropylsilane stationary phase that is popular for routine sugar analysis. This phase is suitable for mono- and disaccharide analysis using a refractive index (RI) or evaporative light scattering detector (ELSD). Isocratic elution (e.g., 75:25, acetonitrile:water) must be used with an RI detector but gradient elution can be utilized for higher efficiency separations when using an ELSD or MS detector.

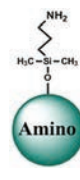

| Particle Size (µm) | Length (mm) | ID (mm) | Part No. |
|--------------------|-------------|---------|-----------------|
| 3.0 | 150 | 3.2 | N9303847 |
| 5.0 | 100 | 2.1 | N9303532 |
| 5.0 | 150 | 2.1 | N9303533 |
| 5.0 | 150 | 4.6 | N9303534 |
| 5.0 | 220 | 4.6 | N9303535 |
| 5.0 | 250 | 4.6 | N9303536 |

Brownlee Validated Carbamate

The Validated Carbamate is a proprietary phase specifically designed for carbamate analysis. This unique stationary phase is capable of separating the 10 target carbamates in just over 10 minutes. The column is capable of analyzing as many as three samples per hour as opposed to less than two per hour on a conventional C18 column. These columns are compatible with both LC/MS and fluorescence detection with post-column derivitization.

| | | 4.6 mm I.D. |
|--------------------|-------------|-----------------|
| Particle Size (µm) | Length (mm) | Part No. |
| 3.0 | 50 | N9303570 |
| 3.0 | 100 | N9303569 |
| 5.0 | 250 | N9303571 |

Brownlee Validated Quat

The Validated Quat is a proprietary, highly retentive, high-purity, base-deactivated, reverse phase specifically designed for the analysis of paraquat, diquat and other quaternary amines.

| | | 4.6 mm I.D. |
|--------------------|-------------|-----------------|
| Particle Size (µm) | Length (mm) | Part No. |
| 5.0 | 150 | N9303886 |

Brownlee Spheri-5® and Spheri-10® Columns

Brownlee Spheri columns are built on small pore (80 Å) silica in 5 and 10 µm particle sizes for analysis of small molecules. These columns are available in three different reverse-phases (C2, C8, C18) and the silica normal phase covers a range of analyte polarities. The Spheri C18 is the most retentive reverse-phase in this family while the C8 is less retentive and can be used for more basic small molecules. Spheri-5 C18 is also available in a monofunctional (comb type) and polyfunctional (ODS) bonding for different analyte selectivities. All Spheri conventional columns are only available in 250 mm length and 4.6 mm i.d.

Features and Benefits

- Small pore (80 Å), 5 & 10 µm, 250 x 4.6 mm columns for small molecule analysis
- C18, C8 and C2 reverse-phases for a range of analyte polarities

Material Characteristics

| Phase | Particle Sizes (µm) | Carbon Load | End Capping | USP Code | Part No. |
|-----------------------------------|---------------------|-------------|-------------|----------|-----------------|
| Spheri-10 C2 | 10 | | No | L16 | 07120005 |
| Spheri-5 C8 | 5 | 6% | Yes | L7 | 07120012 |
| Spheri-5 C18 | 5 | 11% | Yes | L1 | 07120016 |
| Spheri-10 C18 | 10 | 11% | Yes | L1 | 07120001 |
| Spheri-5 C18 ODS (Polyfunctional) | 5 | 14% | Yes | L1 | 07120019 |
| Spheri-5 Silica | 5 | | | L3 | 07120023 |

CONVENTIONAL COLUMNS - GUARD COLUMNS



Brownlee Conventional Guard Column Holders and Pre-Filters

The Brownlee conventional column pre-filter and guard column holder systems allow you to select from three different levels of column protection that couple directly to the head of your column. The high pressure filter (N9303711) simply contains a filter frit selectable in two different diameters (2.0 mm or 4.0 mm) and two different frit porosities (2.0 μm or 0.5 μm) for basic protection against particulates in the sample or mobile phase. The 10 mm guard cartridge holder without a pre-filter (N9303713) provides protection against compounds that irreversibly absorb onto the stationary phase. The 10 mm guard cartridge holder with a pre-filter (N9303712) provides the ultimate in column protection with a selectable filter frit for elimination of particulates along with a guard cartridge packed with a selectable stationary phase to protection against compounds that irreversibly absorb onto the stationary phase.

Guard Column Holders and Pre-Filters

| Description | Part No. |
|---|-----------------|
| 10 mm guard cartridge holder with filter | N9303713 |
| 10 mm guard cartridge holder without filter | N9303712 |
| High pressure filter | N9303711 |
| Peek tip standard fittings | N9303714 |
| Replacement cap frits 2.0 mm, 2.0 μm | N9303717 |
| Replacement cap frits 4.0 mm, 0.5 μm | N9303716 |
| Replacement cap frits 4.0 mm, 2.0 μm | N9303715 |

Brownlee Analytical Guard Cartridges

Length: 10 mm Particle Size: 5 μm Quantity: 3/pkg

| Phase | 2.1 mm ID | 4.0 mm ID |
|--------|-----------------|-----------------|
| | Part No. | Part No. |
| Amino | N9303674 | N9303675 |
| C18 | N9303676 | N9303677 |
| C8 | N9303678 | N9303679 |
| Cyano | N9303680 | N9303681 |
| PAH | N9303682 | N9303683 |
| Phenyl | N9303684 | N9303685 |
| Silica | N9303686 | N9303687 |

Brownlee Analytical Guard Cartridges

Length: 10 mm Particle Size: 5 μm Quantity: 3/pkg

| Phase | 4.0 mm ID |
|------------|-----------------|
| | Part No. |
| C18 | N9303867 |
| Aq C18 | N9303909 |
| Cyano | N9303872 |
| Biphenyl | N9303893 |
| Phenyl | N9303877 |
| PFP Propyl | N9303901 |
| Silica | N9303882 |

Brownlee Analytical DB and HRes Guard Cartridges

Length: 20 mm Particle Size: 5 µm Quantity: 3/pkg

| Phase | 4.0 mm ID Part No. |
|------------|-----------------------|
| C18 | N9303868 |
| Aq C18 | N9303910 |
| Cyano | N9303873 |
| Biphenyl | N9303894 |
| Phenyl | N9303878 |
| PFP Propyl | N9303902 |
| Silica | N9303883 |

Brownlee Choice Guard Cartridges

Length: 10 mm Particle Size: 5 µm Quantity: 3/pkg

| Phase | 2.1 mm ID Part No. | 4.0 mm ID Part No. |
|---------------|-----------------------|-----------------------|
| Basix | N9303666 | N9303667 |
| C18 | N9303668 | N9303669 |
| Aq C18 | | N9303938* |
| Organic Acids | N9303670 | N9303671 |
| PFP Propyl | N9303672 | N9303673 |
| Biphenyl | | N9303943** |

*This column is also available in 20mm x 4.0mm under Part No. N9303937
 ** This column is also available in 20mm x 4.0mm under Part No. N9303944

Brownlee Bio DB Guard Cartridges

Length: 10 mm Particle Size: 5 µm Quantity: 3/pkg

| Phase | 2.1 mm ID Part No. | 4.0 mm ID Part No. |
|-------|-----------------------|-----------------------|
| C18 | N9303708 | N9303707 |
| C8 | N9303709 | N9303710 |

Brownlee Validated Guard Cartridges

Length: 10 mm Particle Size: 5 µm Quantity: 3/pkg

| Phase | 2.1 mm ID Part No. | 4.0 mm ID Part No. |
|------------|-----------------------|-----------------------|
| Amino | N9303688 | N9303689 |
| Aq C18 | N9303690 | N9303691 |
| C1 | | N9303722 |
| C4 | | N9303723 |
| C8 | N9303695 | N9303696 |
| C18 | N9303693 | N9303694* |
| Carbamate | N9303697 | N9303698 |
| Cyano | N9303699 | N9303700 |
| IBD | N9303701 | N9303702 |
| PFP Propyl | N9303703 | N9303704 |
| Phenyl | N9303705 | N9303706 |

*This column is also available in 10µm under Part No. N9303692

Brownlee Sorbents

PerkinElmer Brownlee™ cartridge columns are offered in a wide range of sorbent material. Choose the right sorbent for the analysis and mode of separation being used.

Aquapore® – is a wide-pore, silica-based support suitable for the separation of large biopolymers.

Spheri-5® – is a small-pore, silica-based solvent for separating small molecules. Both monofunctional (comb-type) and polyfunctional (polymerized loop-type) C8 and C18 sorbents are available.

Polypore® – is a polymer-based (microporous, 10 µm) sorbent for the analysis of organic acids and sugars.

Validated™ – is a small-pore, silica-based C18 sorbent for small molecules, specifically for consistent pharmaceutical assays.

Pecosphere™ – is a small-pore, silica-based sorbent for HPLC of small molecules.

Reduced Activity – is a small-pore, base deactivated silica-based, reversed-phase sorbent (C18 or C8) developed for HPLC of basic analytes and pharmaceuticals.

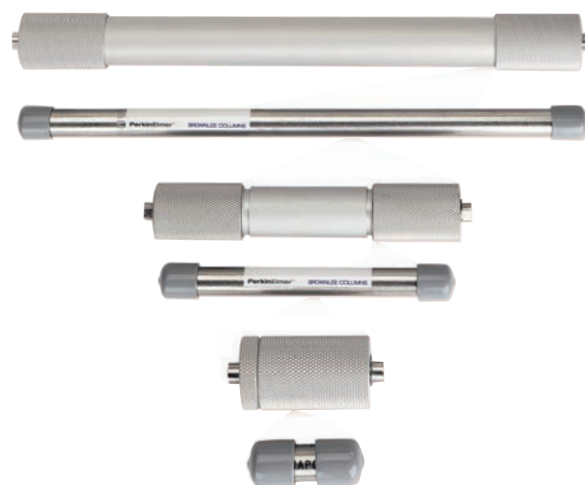

CHOICE™ – is a small-pore, base deactivated silica-based, reversed-phase sorbent (C18) developed for LC/MS separations.

Peco HCODS – is especially suited for reversed-phase separation of proteins and peptides.

Brownlee Cartridge Columns

| Column | Functionality | Pore Diameter Å | % Carbon | End Cap | Applications |
|------------------|--------------------------------|-----------------|----------|---------|--|
| Aquapore | AX-300 (anion exchange) | 300 | | | Silica-based support for larger anionic compounds |
| Aquapore | OD-300 (C18) | 300 | 10 | Yes | Silica-based support for larger compounds by reversed-phase |
| Aquapore | RP-300 (C8) | 300 | 5 | Yes | Same as above, but for slightly more polar compounds |
| Aquapore | BU-300 (C4) | 300 | 3 | Yes | Same as above, but for even somewhat more polar compounds |
| Choice | C18 | 100 | 12 | Yes | For high speed/efficiency separation of basic compounds/pharmaceuticals |
| Choice | C8 | 100 | 7 | Yes | For high speed/efficiency separation of basic compounds/pharmaceuticals |
| Choice | PFPP (Pentafluorophenylpropyl) | 100 | 5 | Yes | For high speed/efficiency separation of basic drugs, especially for LC/MS |
| Pecosphere | C18, monofunctional | 80 | 11 | Yes | Reversed-phase column for fast separation of smaller compounds |
| Pecosphere CR | C18 | 80 | 11 | Yes | Same as above, but for more basic compounds |
| Pecosphere CR | C8 | 80 | 11 | Yes | Same as above, but, also, for slightly more polar compounds |
| Peco HCODS | C18, polyfunctional | 300 | 9 | No | Especially suited for reversed-phase separation of proteins and peptides |
| Polypore | CA (calcium form), Mixed Mode | Microporous | | | Especially suited for separation of organic acids, as well as sugars |
| Polypore | H (hydrogen form), Mixed Mode | Microporous | | | Especially suited for separation of sugars, as well as organic acids |
| Reduced Activity | C18 | 80 | 12 | Yes | Reversed-phase sorbent geared for fast separation of basic compounds/pharmaceuticals |
| Reduced Activity | C8 | 80 | 5 | Yes | Same as above, but for slightly more polar compounds |
| Spheri-5 | RP-18 (monofunctional C18) | 80 | 11 | Yes | Reversed-phase separation of smaller compounds |
| Spheri-5 | ODS (polyfunctional C18) | 80 | 14 | Yes | Same as above, but with somewhat different selectivity |
| Spheri-5 | RP-8 (monofunctional C8) | 80 | 6 | Yes | Reversed-phase separation of more basic smaller compounds |
| Spheri-5 | Phenyl (C5) | 80 | 6 | Yes | Especially suited for hydrophobic interaction separation of biomolecules, where the activity of the compound must be preserved |
| Spheri-5 | Amino | 80 | 3 | No | Normal-phase separation of smaller, relatively more polar compounds |
| Spheri-5 | Cyano | 80 | 4 | No | Same as above, but with somewhat different selectivity |
| Spheri-5 | Silica | 80 | | | Same as above, but with different selectivity |
| Validated | C18 | 100 | 18 | Yes | Reversed-phase separations in which very little variation in both lot-to-lot and column-to-column variability can be tolerated |
| VeloSep | RP-18 (C18) | 100 | 14 | Yes | Reversed-phase column for high through-put and minimal solvent usage |
| VeloSep | RP-8 (C8) | 100 | 7 | Yes | Same as above, but for slightly more polar compounds |

Brownlee Aquapore Columns

Brownlee Aquapore columns are built on large pore 300 Å, 7 µm particle size silica for the analysis of large biomolecules such as peptides and proteins. Large pore stationary phases are required for the analysis of large molecules because the analytes need to penetrate the pores to improve retention and resolution. The OD-300, RP-300 and BU-300 are reverse-phase silicas modified with C18, C8 and C4, respectively. The longer alkyl chains in the stationary phase result in stronger retention of hydrophobic molecules (i.e. retention C18 > C8 > C4). The AX-300 is a weak anion exchanger composed of cross-linked polyethyleneimine coated on the silica surface.

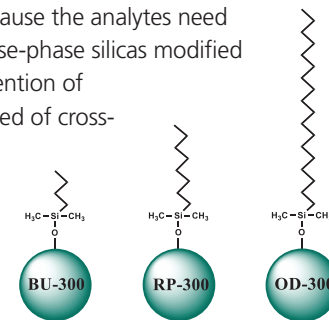

Features and Benefits

- Rugged, spherical silica particles with 300 Å pore size
- Excellent choice for separation of peptides, proteins and other large molecules
- Available in ion-exchange and reverse-phases

Material Characteristics

| Phase* | Particle Sizes (µm) | Pore Size (Å) | Carbon Load | End Capping | pH Stability | Temp. Limit | USP Code |
|--------------|---------------------|---------------|-------------|-------------|--------------|-------------|----------|
| BU-300 (C4) | 7.0 | 300 | 3% | Yes | 2.5 – 8.0 | 60 °C | L26 |
| RP-300 (C8) | 7.0 | 300 | 5% | Yes | 2.5 – 8.0 | 60 °C | L7 |
| OD-300 (C18) | 7.0 | 300 | 10% | Yes | 2.5 – 8.0 | 60 °C | L1 |
| AX-300* | 7.0 | 300 | | | 2.5 – 8.0 | 60 °C | L14 |

* Weak Anion Exchange

| Phase | Length (mm) | Quantity | 2.1 mm i.d. | | 4.6 mm i.d. | | Column Holder Code * | |
|--------|-------------|----------|-------------|----------|-------------|-----------|----------------------|--|
| | | | Part No. | Part No. | w/o Guard | w/ Guard | | |
| BU-300 | 30 | 2 Pack | 07110062 | 07110061 | A | A + K + L | | |
| | 100 | Each | 07110064 | | C | D | | |
| | 220 | Each | 07110066 | | G | H | | |
| RP-300 | 30 | 2 Pack | 07110056 | 07110055 | A | A + K + L | | |
| | 100 | Each | 07110058 | 07110057 | C | D | | |
| | 220 | Each | 07110060 | 07110059 | G | H | | |
| OD-300 | 30 | 2 Pack | 07110234 | 07110235 | A | A + K + L | | |
| | 100 | Each | 07110233 | 07110232 | C | D | | |
| | 220 | Each | 07110236 | 07110231 | G | H | | |
| AX-300 | 30 | 2 Pack | 07110074 | 07110073 | A | A + K + L | | |
| | 100 | Each | 07110076 | 07110075 | C | D | | |
| | 220 | Each | | 07110077 | G | H | | |

* See Page 153 for column holder codes and part numbers

Brownlee Spheri-5® and Spheri-10® Cartridge Columns

The Brownlee Spheri line of columns is based on a small-pore (80 Å) silica-based sorbent for optimized for separating small molecules. Spheri-5® columns are based on 5 µm particle size silica and Spheri-10® incorporates a 10 µm silica particle. Spheri-5 columns are available in both reverse phases (RP-8, RP-18, ODS & Phenyl) and polar normal phases (amino, cyano & silica). The Spheri-5 reverse phase C18 type sorbents are available in a monofunctional comb-type (RP-18) and a polyfunctional loop-type (ODS) which provide slight differences in selectivity.

Features and Benefits

- Small pore size (80 Å) designed for separating small molecules
- Reverse phase sorbents in 5 µm and 10 µm particles sizes and normal phase 5 µm particles
- Available in ion-exchange and reverse-phases

Material Characteristics

| Phase* | Particle Sizes (µm) | Pore Size (Å) | Carbon Load | End Capping | pH Stability | Temp. Limit | USP Code |
|--------|---------------------|---------------|-------------|-------------|--------------|-------------|----------|
| RP-8 | 5.0, 10.0 | 80 | 6% | Yes | 2.5 – 8.0 | 60 °C | L7 |
| RP-18 | 5.0, 10.0 | 80 | 11% | Yes | 2.5 – 8.0 | 60 °C | L1 |
| ODS | 5.0 | 80 | 14% | Yes | 2.5 – 8.0 | 60 °C | L1 |
| Phenyl | 5.0 | 80 | 6% | Yes | 2.5 – 8.0 | 60 °C | L11 |
| Amino | 5.0 | 80 | 3% | No | 2.5 – 8.0 | 60 °C | L8 |
| Cyano | 5.0 | 80 | 4% | No | 2.5 – 8.0 | 60 °C | L10 |
| Silica | 5.0 | 80 | | | 2.5 – 8.0 | 60 °C | L3 |

| Phase | Length (mm) | Particle Size | Qty | Material Characteristics | | Column Holder Code * | |
|-----------------|-------------|---------------|--------|--------------------------|-------------|----------------------|-----------|
| | | | | 2.1 mm i.d. | 4.6 mm i.d. | w/o Guard | w/ Guard |
| Spheri-5 RP-8 | 30 | 5 µm | 2 Pack | 07110002 | 07110001 | A | A + K + L |
| | 100 | 5 µm | Each | 07110004 | 07110003 | C | D |
| | 220 | 5 µm | Each | 07110006 | 07110005 | G | H |
| Spheri-5 RP-18 | 30 | 5 µm | 2 Pack | 07110014 | 07110013 | A | A + K + L |
| | 100 | 5 µm | Each | 07110016 | 07110015 | C | D |
| | 220 | 5 µm | Each | 07110018 | 07110017 | G | H |
| Spheri-5 ODS | 30 | 5 µm | 2 Pack | 07110020 | 07110019 | A | A + K + L |
| | 100 | 5 µm | Each | 07110022 | 07110021 | C | D |
| | 220 | 5 µm | Each | 07110024 | 07110023 | G | H |
| Spheri-5 Phenyl | 30 | 5 µm | 2 Pack | | 07110025 | A | A + K + L |
| | 100 | 5 µm | Each | 07110028 | 07110027 | C | D |
| | 220 | 5 µm | Each | | 07110029 | G | H |
| Spheri-5 Amino | 30 | 5 µm | 2 Pack | | 07110037 | A | A + K + L |
| | 100 | 5 µm | Each | | 07110039 | C | D |
| | 220 | 5 µm | Each | 07110042 | 07110041 | G | H |
| Spheri-5 Cyano | 30 | 5 µm | 2 Pack | 07110044 | 07110043 | A | A + K + L |
| | 100 | 5 µm | Each | 07110046 | 07110045 | C | D |
| | 220 | 5 µm | Each | | 07110047 | G | H |
| Spheri-5 Silica | 30 | 5 µm | 2 Pack | 07110032 | 07110031 | A | A + K + L |
| | 100 | 5 µm | Each | 07110034 | 07110033 | C | D |

* See Page 153 for column holder codes and part numbers

Brownlee Pecosphere Cartridge Columns

PerkinElmer pioneered the development of Fast HPLC and introduced the popular 3 µm particle size “3 x 3” Columns (33 mm x 4.6 mm) in the 1980s. The “3 x 3” columns are capable of very rapid analysis and still they are still very popular in many laboratories because of the economical price and reliable performance. The Pecosphere cartridges are also available 83 mm long “3 x 8” and 150 mm long “3 x 150” columns (4.6 mm ID) for the separation of more complex mixtures.

Pecosphere columns are packed with rugged, high purity silica in 3 µm and 5 µm particle sizes. These columns are available in 80 Å pore size particles with standard end-capping for the analysis of acidic and neutral analytes and a special end-capped Reduced Activity (RA) version that is especially suited for the analysis basic analytes. There is a large pore (300 Å), non-end-capped, polyfunctional C18 version (HCODS) for the separation of peptides and proteins. In addition the 10 µm particles size C18 Scavenger cartridge designed to remove contaminants from the mobile phase when installed prior to the HPLC injector.

Features and Benefits

- The Pecosphere “3 x 3” column is the world’s first fast HPLC column introduced in the 1980’s
- Reduced Activity C18 & C8 with low silanol activity for the analysis of basic compounds
- 300 Å pore size Peco HCODS for the separation of peptides and proteins

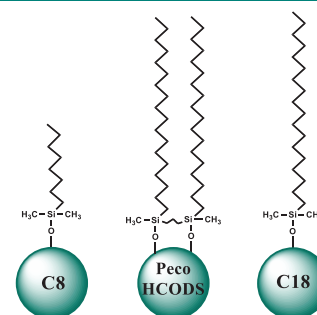
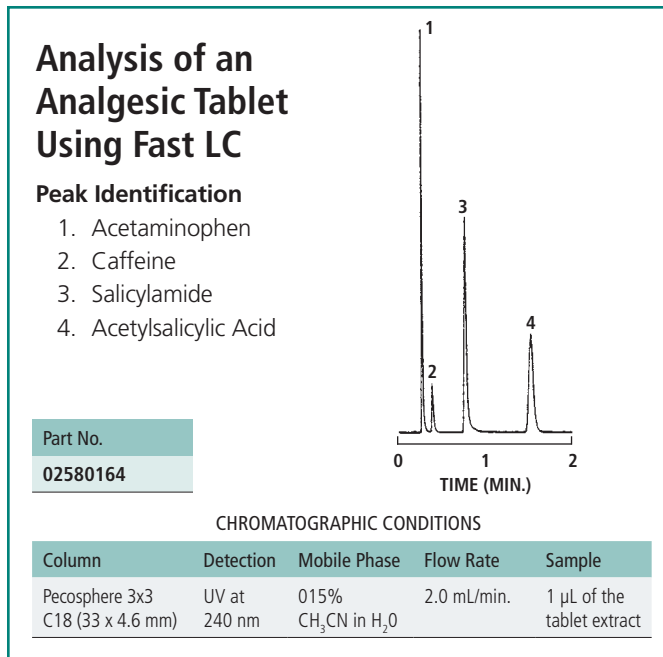

Material Characteristics

| Phase | Particle Sizes (µm) | Pore Size (Å) | Carbon Load | Surface Area (M ² /g) | End Capping | pH Stability | USP Code |
|---------------|---------------------|---------------|-------------|----------------------------------|-------------|--------------|----------|
| C18 | 3.0, 5.0 | 80 | 11% | 170 | Yes | 2.0 – 8.0 | L1 |
| RA C8 | 3.0, 5.0 | 80 | 5% | 200 | Yes | 2.0 – 8.0 | L7 |
| RA C18 | 3.0, 5.0 | 80 | 12% | 200 | Yes | 2.0 – 8.0 | L1 |
| Peco HCODS | 5.0 | 300 | 9% | 90 | No | 2.5 – 8.0 | L1 |
| C18 Scavenger | 10.0 | 80 | 11% | 170 | Yes | 2.0 – 8.0 | L1 |

| Phase | Length (mm) | Particle Size | Qty | 4.6 mm i.d. | |
|---------------------|-------------|---------------|--------|-----------------|----------------|
| | | | | Part No. | Column Holder* |
| Aquapore Octyl (C8) | 33 | 3 µm | 5 Pack | 02580164 | T |
| | 83 | 3 µm | Each | 02580166 | U |
| | 150 | 5 µm | Each | 02580169 | F |
| Red. Act. C18 | 33 | 3 µm | 5 Pack | 02580195 | T |
| | 83 | 3 µm | Each | 02580194 | U |
| | 150 | 5 µm | Each | N9303396 | F |
| Red. Act. C8 | 33 | 3 µm | 5 Pack | 02580191 | T |
| | 83 | 3 µm | Each | 02580192 | U |
| | 150 | 5 µm | Each | 02580168 | F |

| Phase | Length (mm) | Particle Size | Qty | 4.6 mm i.d. | |
|--------------------|-------------|---------------|--------|-----------------|----------------|
| | | | | Part No. | Column Holder* |
| HCDOS | 150 | 3 µm | Each | 02580213 | F |
| C18 Scavenger | 33 | 10 µm | 5 Pack | 02580202 | T |
| Silica Scavenger | 33 | 10 µm | 5 Pack | 02580203 | |
| C18 Scavenger Kit† | 33 | 10 µm | Each | 02580204 | |

* See Page 153 for column holder codes and part numbers
† Scavenger kit includes C18 cartridge (02580202) and holder (07150028)

Brownlee Validated Cartridge Columns

The Brownlee Validated C18 sorbent is derived from a neutral "Type B" silica with inherent low silanophilic activity. Each sorbent lot is tested to meet stringent specifications for the separation of basic, neutral, and acidic test probes. Column lifetime studies and additional selectivity evaluations using real samples are also conducted. A high-temperature bonding technique is coupled with an exhaustive end-capping procedure to ensure maximum coverage of the silica surface. A proprietary treatment step is used to further eliminate any trace residual metals in the silica that create active adsorptive sites. The result is a highly deactivated column which yields excellent peak shape for difficult basic analytes, pharmaceuticals, and small peptides.

Features and Benefits

- Base deactivated compatible with acids, bases and neutrals
- Guaranteed batch-to-batch reproducibility
- Test chromatogram and Certificate of Compliance shipped with each column (except NewGuard® and 30 mm columns)

**Validated C18
(100 x 4.6 mm),
75/25 MeOH/Water
1 mL/min., 30 °C,
230 nm detection**

Performance of Validated Column with basic, acidic, and neutral test probes.

Part No.
00402241

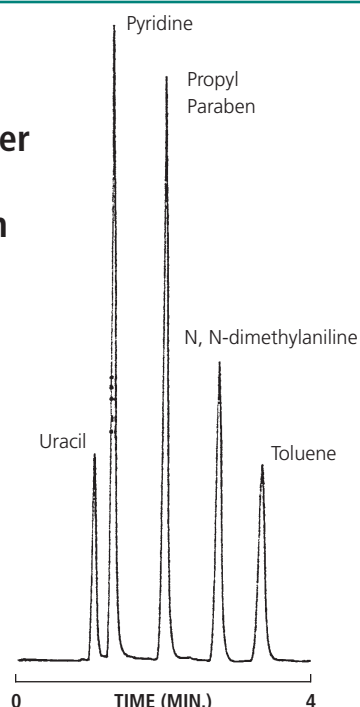

Material Characteristics

| Phase | Particle Sizes (µm) | Pore Size (Å) | Carbon Load | End Capping | Surface Area (m ² /g) | pH Stability | Temp. Limit | USP Code |
|---------------|---------------------|---------------|-------------|-------------|----------------------------------|--------------|-------------|----------|
| Validated C18 | 5.0 | 100 | 18% | Yes | 350 | 2.5 – 8.0 | 60 °C | L1 |

| Phase | Length (mm) | Particle Size | Quantity | 2.1 mm i.d. | | 4.6 mm i.d. | | Column Holder Code * | |
|---------------|-------------|---------------|----------|-----------------|-----------------|-------------|-----------|----------------------|--|
| | | | | Part No. | Part No. | w/o Guard | w/ Guard | | |
| Validated C18 | 30 | 5 µm | Each | | 00402239 | A | A + K + L | | |
| | 100 | 5 µm | Each | 00402240 | 00402241 | C | D | | |
| | 150 | 5 µm | Each | | 00403053 | F | F + K + L | | |
| | 220 | 5 µm | Each | | 00402243 | G | H | | |

* See Page 131 for column holder codes and part numbers

Brownlee Polypore® Cartridge Columns

Brownlee Polypore® columns are 10 mm, microporous polymer based columns especially suited for the analysis of sugars and organic acids.

Features and Benefits

- Available in calcium (CA) and hydrogen (H) counter ion forms.
- For analysis of sugars and organic acids

Material Characteristics

| Phase | Particle Sizes (µm) | Pore Size | pH Stability | Temp. Limit | USP Code |
|--------------|---------------------|-------------|--------------|-------------|----------|
| Polypore® CA | 10.0 | Microporous | 1 - 14 | 90 °C | L19 |
| Polypore® H | 10.0 | Microporous | 1 - 14 | 90 °C | L17 |

| Phase | Length (mm) | Particle Size | Quantity | 4.6 mm i.d. | |
|--------------|-------------|---------------|----------|-----------------|----------------|
| | | | | Part No. | Column Holder* |
| Polypore® H | 30 | 10 µm | 2 Pack | 07110085 | A |
| | 100 | 10 µm | Each | 07110087 | C |
| | 220 | 10 µm | Each | 07110089 | G |
| Polypore® CA | 30 | 10 µm | 2 Pack | 07110091 | A |
| | 100 | 10 µm | Each | 07110093 | C |
| | 220 | 10 µm | Each | 07110095 | G |

* See Page 153 for column holder codes and part numbers

Organic Acids

Peak Identification

- | | |
|-----------------------|------------------|
| 1. Oxalic Acid | 5. Succinic Acid |
| 2. Citric Acid | 6. Formic Acid |
| 3. α-Ketogutaric Acid | 7. Acetic Acid |
| 4. Malic Acid | 8. Fumaric Acid |
| | 9. Butyric Acid |

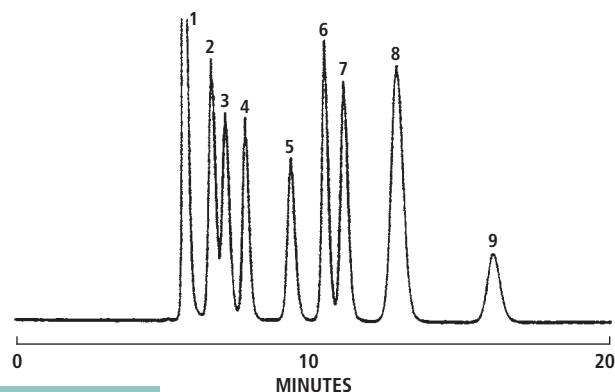

Part No.
07110089

CHROMATOGRAPHIC CONDITIONS

| Column | Detection | Mobile Phase | Flow Rate | Temperature |
|--------------------------------|-----------|---------------------------------------|--------------|-------------|
| Polypore H (220 x 4.6 mm i.d.) | 210 nm | 0.01 N H ₂ SO ₄ | 0.15 mL/min. | 25 °C |

Brownlee Prep-10 Semi-Preparative Cartridge Columns

The Brownlee Prep-10 columns are 10 mm i.d. cartridges packed with 20 µm particle size, 300 Å pore size Aquapore® sorbents for easy scale up from our 7 µm analytical Aquapore® columns. These unique 100 mm and 250 mm cartridges incorporate a moveable inlet plug and filter which compensates for changes in bed volume with continued use. The typical capacity of the 250 mm cartridge is 50 mg to 1 g depending on the resolution and purity required.

Features and Benefits

- Rugged, spherical silica particles with 300 Å pore size
- Excellent choice for separation of peptides, proteins and other large molecules
- Available in ion-exchange and reverse-phases

Material Characteristics

| Phase | Particle Sizes (µm) | Pore Size (Å) | Carbon Load | End Capping | Surface Area (m ₂ /g) | pH Stability | Temp. Limit | USP Code |
|---------------------|---------------------|---------------|-------------|-------------|----------------------------------|--------------|-------------|----------|
| Aquapore Octyl (C8) | 20.0 | 300 | 5% | Yes | 100 | 2.5 – 8.0 | 60 °C | L7 |
| Aquapore ODS (C18) | 20.0 | 300 | 10% | Yes | 100 | 2.5 – 8.0 | 60 °C | L1 |

| Phase | Length (mm) | Particle Size | Quantity | 4.6 mm i.d. | |
|---------------------|-------------|---------------|----------|-----------------|----------------|
| | | | | Part No. | Column Holder* |
| Aquapore Octyl (C8) | 100 | 20 µm | Each | 07110165 | R |
| | 250 | 20 µm | Each | 07110166 | S |

| Phase | Length (mm) | Particle Size | Quantity | 4.6 mm i.d. | |
|--------------------|-------------|---------------|----------|-----------------|----------------|
| | | | | Part No. | Column Holder* |
| Aquapore ODS (C18) | 100 | 20 µm | Each | 07110114 | R |
| | 250 | 20 µm | Each | 07110163 | S |

* See Page 131 for column holder codes and part numbers

Brownlee CHOICE Cartridge Columns for LC/MS

The Brownlee CHOICE cartridge columns are specifically designed in column dimensions for high throughput LC/MS analysis. These cartridges are available in three reverse phases (C8, C18 and PFPP) with particle sizes of 3 µm and 5 µm. The smaller internal diameter columns offer high sensitivity even with lower sample concentrations. The pentafluorophenyl propyl (PFPP) phase is ideal for the analysis of basic drugs. This phase has been shown to efficiently separate basic drugs in a 90% acetonitrile/water mobile phase eliminating the need for ion suppression agents commonly used with C18 column for the analysis of these types of compounds.

Features and Benefits

- Suitable for high throughput LC/MS analysis
- PFPP phase for basic drugs

Material Characteristics

| Phase | Particle Sizes (µm) | Pore Size (Å) | Carbon Load | End Capping | Surface Area (m ² /g) | pH Stability | Temp. Limit | USP Code |
|-------------|---------------------|---------------|-------------|-------------|----------------------------------|--------------|-------------|----------|
| CHOICE C8 | 3.0 | 100 | 7% | Yes | 350 | 2.5 – 8.0 | 60 °C | L7 |
| CHOICE C18 | 3.0, 5.0 | 100 | 12% | Yes | 350 | 2.5 – 8.0 | 60 °C | L1 |
| CHOICE PFPP | 5.0 | 100 | 5% | Yes | 350 | 2.5 – 8.0 | 60 °C | L43 |

| Phase | Length (mm) | Particle Size | Quantity | 2.1 mm i.d. | 3.21 mm i.d. | 4.6 mm i.d. | Column Holder* |
|--------------|-------------|---------------|----------|-----------------|-----------------|-----------------|----------------|
| | | | | Part No. | Part No. | Part No. | |
| CHOICE® C8 | 30 | 3 µm | Each | N2580012 | | | A |
| | 50 | 3 µm | Each | | N2580013 | | B |
| CHOICE® C18 | 30 | 3 µm | Each | | N2580003 | | A |
| | 30 | 5 µm | Each | | | N2580020 | A |
| | 50 | 5 µm | Each | | N2580022 | N2580021 | B |
| CHOICE® PFPP | 30 | 5 µm | Each | N2580042 | | | A |

* See Page 153 for column holder codes and part numbers

Brownlee VeloSep® Cartridge Columns

Brownlee VeloSep® columns are 3.2 mm i.d. cartridges packed with 3 µm reverse phase silica stationary phases for high throughput analysis.

Features and Benefits

- 3.2 mm i.d. improves sensitivity while reducing mobile phase consumption
- Available in 3 µm C8 and C18 sorbents in 40 mm and 100 mm column lengths

Material Characteristics

| Phase | Particle Sizes (µm) | Pore Size (Å) | Carbon Load | End Capping | Surface Area (m ² /g) | pH Stability | Temp. Limit | USP Code |
|---------------------|---------------------|---------------|-------------|-------------|----------------------------------|--------------|-------------|----------|
| VeloSep RP-8 (C8) | 3.0 | 100 | 7% | Yes | 170 | 2.5 – 8.0 | 60 °C | L7 |
| VeloSep RP-18 (C18) | 3.0 | 100 | 14% | Yes | 170 | 2.5 – 8.0 | 60 °C | L1 |

| Phase | Length (mm) | Particle Size | Quantity | 4.6 mm i.d. | |
|---------------|-------------|---------------|----------|-----------------|----------------|
| | | | | Part No. | Column Holder* |
| VeloSep RP-8 | 40 | 3 µm | 2 Pack | 07110189 | A |
| | 100 | 3 µm | Each | 07110190 | C |
| VeloSep RP-18 | 40 | 3 µm | 2 Pack | 07110191 | A |
| | 100 | 3 µm | Each | 07110192 | C |

* See Page 153 for column holder codes and part numbers

NewGuard Columns

NewGuard cartridges are small guard cartridges (15 mm x 3.2 mm i.d.) packed with 5 or 7 µm sorbents. NewGuard cartridges prolong column life by eliminating particulates, contaminants, and strongly bound sample components. They act as replaceable disposable heads of your analytical columns. There is negligible loss of efficiency and little effect on retention or resolution. NewGuards are available in a convenient 3-pack and can be coupled directly to any MPLC cartridge with a union (07150018).

Features and Benefits

- Prolong column life by 2 to 5 times
- Protect your column from particulates and strongly bound sample components
- Optimized dimensions to prevent loss of resolution
- Easy coupling to MPLC cartridges or conventional columns
- Finger-tight seal to 7,000 psi using NewGuard holders
- Can be used for sample preconcentration (connected to sample injection loop)

15 mm cartridge*, 3.2 mm i.d., 3 per pkg.

| Description | Size | Shape | Part No. |
|-------------------------|------|-----------|----------|
| Amino, Aquapore Amino | 7 µm | Spherical | 07110098 |
| Anion, Aquapore Anion | 7 µm | Spherical | 07110102 |
| Cyano, Aquapore Cyano | 7 µm | Spherical | 07110100 |
| Diol, Aquapore Diol | 7 µm | Spherical | 07110105 |
| Phenyl, Aquapore Phenyl | 7 µm | Spherical | 07110096 |
| RP-2, Aquapore Dimethyl | 7 µm | Spherical | 07110086 |
| RP-4, Aquapore Butyl | 7 µm | Spherical | 07110088 |
| RP-8, Aquapore Octyl | 7 µm | Spherical | 07110090 |
| RP-18, Aquapore ODS | 7 µm | Spherical | 07110092 |
| Silica, Aquapore Silica | 7 µm | Spherical | 07110106 |
| Validated®, C18 | 5 µm | Spherical | 00402237 |

* Requires holder (07150001)

Note: Actual bed length of NewGuard is about 13 mm

Standards Solutions

| Description | Part No. |
|--|----------|
| Test Mix | |
| LC Gradient Test Mix | N9334010 |
| Universal Test Mix for Reversed-phase (5 mL/pkg) | 00890893 |
| Standards | |
| HPLC SV Calibration Mix No.5/610 PAH | 00891542 |
| HPLC 610 Calibration Mix A | 00891543 |
| HPLC 610 Calibration Mix B | 00891544 |



NewGuard cartridges directly coupled to a 220 mm MPLC cartridge and connected externally to a 250 mm conventional column.

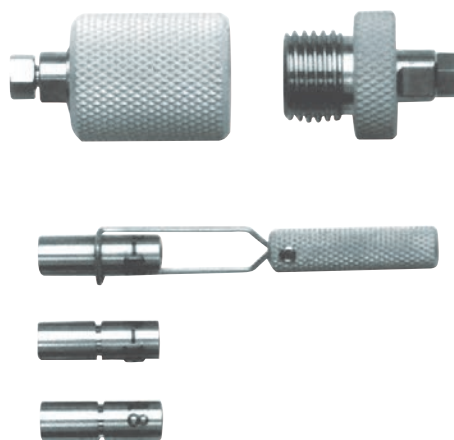























View of the NewGuard holder and a NewGuard 3-pack.

NewGuard Accessories

Replacement Seals for MPLC and Prep-10 Holders

| Description | Part No. |
|--|----------|
| Prep-10 Inlet Seal | |
| One each (Prep-10 Seal Replacement Kit Tools Required) | 07150012 |
| Prep-10 Outlet Seal | |
| One each (Prep-10 Seal Replacement Kit Tools Required) | 07150026 |
| Seals for MPLC Holders | |
| Two 7,000 psi seals (Seal Replacement Kit Tools Required) | 07150024 |
| Seal Replacement Kit for MPLC Holders | |
| Tools and Two 7,000 psi Seals | 07150023 |

Finger-Tight Holders

| | Code | Name | Description | Part No. |
|---|------|-------------------------------|--|----------|
| MPLC Cartridge Holders | | | | |
|  | A | 30 mm Holder | Single 30 mm holder for MPLC cartridges | 07150013 |
|  | B | 50 mm Holder | Single 50 mm holder for MPLC cartridges | N2580030 |
|  | C | 100 mm Holder | Single 100 mm holder for MPLC cartridges | 07150014 |
|  | D | 100 mm NewGuard System Holder | MPLC holder for directly coupling a NewGuard and a 100 mm cartridge | 07150016 |
|  | E | 130 mm System Holder | Holder for directly coupling a 30 mm and 100 mm MPLC cartridge | 07150032 |
|  | F | 150 mm Holder | Single 150 mm holder for MPLC cartridges | 07150030 |
|  | G | 220 mm Holder | Single 220 mm holder for MPLC cartridges | 07150015 |
|  | H | 220 mm NewGuard System Holder | MPLC holder for directly coupling a NewGuard and a 220 mm cartridge | 07150017 |
|  | I | 250 mm Holder | Single 250 mm holder for MPLC cartridges | 07150031 |
|  | J | NewGuard Holder | Holder for a single, stand-alone NewGuard cartridge | 07150001 |
|  | K | Union | For direct coupling of two cartridge holders or a NewGuard to any cartridge holder. (NewGuard end assembly required) | 07150018 |
|  | L | NewGuard End Assembly | Used with union to couple a NewGuard to any cartridge holder | 07150002 |
|  | M | End Assembly | End assembly for any MPLC holder body | 07150019 |
|  | N | 30 mm Holder Body | Holder body for 30 mm MPLC cartridge | 07150020 |
|  | O | 100 mm Holder Body | Holder body for 100 mm MPLC cartridge | 07150021 |
|  | P | 220 mm Holder Body | Holder body for 220 mm MPLC cartridge | 07150022 |
|  | Q | Universal Holder Kit | Includes 100 mm and 220 mm holder bodies, 2 end assemblies, 1 union and 1 NewGuard end assembly | 07150025 |
| Prep-10 Cartridge Holders | | | | |
|  | R | 100 mm Prep-10 Holder | Holder for a single 100 mm Prep-10 MPLC cartridge | 07150005 |
|  | S | 250 mm Prep-10 Holder | Holder for a single 250 mm Prep-10 MPLC cartridge | 07150006 |
| Pecosphere Cartridge Holders | | | | |
|  | T | 33 mm Pecosphere Holder | Holder for a 33 mm fast LC Pecosphere cartridge. (Not for use with MPLC cartridges) | 07150028 |
|  | U | 83 mm Pecosphere Holder | Holder for a 83 mm fast LC Pecosphere cartridge. (Not for use with MPLC cartridges) | 07150029 |
|  | V | 100 mm Pecosphere Holder | Holder for a 100 mm fast LC Pecosphere cartridge. (Not for use with MPLC cartridges) | 02580225 |

INTERCHANGEABLE FOR YOUR SAMPLE

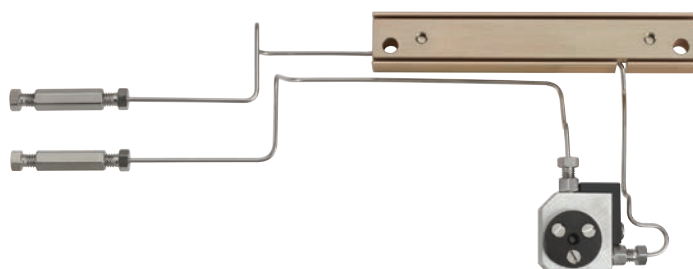

Bio Conversion Kits

There are two kits available; one that contains all of the parts necessary to convert the Series 200 pump and Series 200 autosampler for Bio applications. The other contains all of the parts necessary to convert only the Series 200 Pump for Bio applications.

| Description | Part No. |
|---|-----------------|
| S200 Pump and S200 Autosampler Conversion Kit | N2910035 |
| S200 Pump Conversion Kit | N2910036 |

Pump Seal Kits

| Description | Part No. |
|--|-----------------|
| High Pressure Piston Seal Replacement Kit Includes: Seals (4), Backup Rings and O-Rings | N2910383 |
| Micropump Piston Seal Replacement Kit Includes: Seals and O-Rings | N2910384 |
| Series 200 Pump Maintenance Kit Includes: Fuses, Seals, O-Rings and Seal Tools | N2910345 |



Detector Backpressure Regulator

The detector backpressure regulator is a device that is attached to the outlet of the detector to prevent outgassing in the flowcell, eliminating variations to the detector baseline.

| Description | Material | Part No. |
|---|-----------------|-----------------|
| 40 psi inline backpressure regulator | | N2925090 |
| 2 – 5K psi variable backpressure regulator | | N2925091 |
| Backpressure Regulator Adjustable from 15 – 59 psi | Stainless Steel | 09907126 |

Flexar UV/Vis, Series 200/785A UV/Vis, Flexar PDA and Series 200 EP

These flowcells provide the highest detection limits possible for your sample. The 6 mm pathlength flowcell has been optimized for lower-dispersion LC analysis and is the perfect choice when using narrowbore, 2.1 mm or microbore, 1 mm columns (see Figure 1). The 3 mm pathlength is the choice for semiprep LC to avoid detector saturation at high-solute concentrations.

UV/Vis, PDA, FL and LC-135/235 FLOWCELLS

| Description | Size | Part No. |
|---|--------------------|-----------------|
| Flowcells for Flexar FX-UV/Vis UHPLC Detectors | | |
| Flowcell | 6 mm x 2.4 μ L | N2925090 |
| Flowcell Kit (includes flowcell & detector head plate w/ gasket) | 6 mm x 2.4 μ L | N2920070 |
| Flowcells for Flexar FX-UV/Vis UHPLC Detectors | | |
| Flowcell Kit (includes flowcell w/ heat exchanger and zdv unions) | 10 mm x 15 μ L | N2920070 |
| Flowcell | 10 mm x 15 μ L | N2920124 |
| Flowcell Assembly (w/ zdv unions) | 6 mm x 2.4 μ L | 29000544 |
| Prep Flowcell Assembly (w/ zdv unions) | 3 mm x 1.7 μ L | 29000545 |
| Flowcells for 785A UV/Vis Detectors | | |
| Flowcell | 8 mm x 12 μ L | 29000542 |
| Flowcell Assembly (w/ heat exchanger and zdv unions) | 8 mm x 12 μ L | N2920117 |
| Flowcells for Flexar FX-PDA UHPLC and Series 275 PDA Detectors | | |
| Flowcell (dual-lensed) | 6 mm x 2.4 μ L | N2920128 |
| Flowcells for Flexar and Series 200EP PDA Detectors | | |
| Flowcell | 10 mm x 15 μ L | N2920126 |
| Flowcell Assembly | 10 mm x 15 μ L | N2920160 |
| Flowcells for Series 200 PDA Detectors | | |
| Flowcell | 10 mm x 12 μ L | N2922107 |
| Flowcell | 4.5 mm x 5 μ L | N2922030 |
| FL 3 μ L Flowcell w/ Assembly | | N2922211 |
| Flowcells for LC-135/235 PDA Detectors | | |
| Flowcell Assembly (w/ heat exchanger) | 10 mm x 8 μ L | N2350211 |
| Flowcell | 10 mm x 8 μ L | N2350162 |

FOR OUTSTANDING PERFORMANCE



UV/VIS Deuterium Detector Lamp



Series 200/200 EP Photo Diode Array Detector Lamp

Our extensive quality control and inspection process demands the very best quality sources. Choosing a PerkinElmer deuterium, tungsten or xenon source provides outstanding ultraviolet and true visible performance.

- Exceptional performance anywhere in the detector's 190 – 700 nm wavelength range
- Lamp changes are quick and easy due to a unique self-aligning lamp mount

UV/VIS Detector Lamps

| Components | Part No. |
|--|----------|
| Flexar Series/Series 200/785A UV/VIS Detector Lamps | |
| Deuterium Lamp | N2920149 |
| Tungsten Lamp | N2920146 |
| LC-295 UV/VIS Detector Lamps | |
| Deuterium Lamp | 02712266 |

Refractive Index Detector Lamps

The Flexar Series/Series 200/200s Refractive Index, with its deflection-type design, allows sensitive detection of these compounds with low noise and drift characteristics.

| Components | Part No. |
|----------------------------|----------|
| Series 200/200a | |
| Refraction Index (RI) Lamp | 02712273 |

Photo Diode Array Detector Lamps

The Flexar Series/Series 200/200 EP Photo Diode Array Detector provides true UV/VIS detection and high resolution spectral data. The excellent signal-to-noise characteristics make it ideally suited for low-volume or low concentration samples.

| Components | Part No. |
|-----------------------------|----------|
| Flexar/Series 200 EP | |
| Deuterium Lamp | N2925030 |
| Tungsten Lamp | N2922011 |
| Series 200 | |
| Deuterium Lamp | N2922046 |
| Tungsten Lamp | N2922011 |
| LC-135C/235 | |
| Detector Lamp | N2351285 |

Fluorescence Detector Lamps

The major benefit afforded by fluorescence detection is the inherent high sensitivity of the technique coupled with outstanding specificity. The Series 200a Fluorescence Detector provides signal to noise ratio of >700:1 from trace analysis using a 150 W xenon source.

| Components | Part No. |
|-------------------------------|----------|
| Flexar/Series 200/200a | |
| Xenon Lamp | N2922082 |
| Flexar/Series 200/200a | |
| Xenon Lamp | L2251157 |
| Festoon Lamp | 04969486 |

ENHANCE PUMP PERFORMANCE

Vacuum Degassing Kits

Using a solvent degassing system will extend the performance of your pump. PerkinElmer offers both vacuum degassing systems that can handle all your degassing requirements.

On-Line Vacuum Degasser Kit

This is a low-volume, high efficiency on-line module for the removal of dissolved gasses from HPLC solvents. The vacuum degasser is available in 3 and 5 channel models to support isocratic, binary and quaternary pumps as well as degassing of autosampler flush solvent.



| Description | Part No. |
|--|-----------------|
| 3-channel Vacuum Degassing Package. Includes: a Vacuum Degasser, one 1 L Bottle with Cap, one 2 L Bottle with Cap, one Organizer Tray and Accessory | N2600571 |
| 5-channel Vacuum Degassing Package. Includes: a Vacuum Degasser, two 1 L Bottle with Caps, two 2 L Bottles with Caps, Solvent Tray and Organizer | N2600570 |
| Binary Bottle Cap Kit. Includes: two Caps, Tubing, Fittings and Labels required for two Solvent Bottles | N2600522 |
| Quaternary Bottle Cap Kit. Includes: four Caps, Tubing, Fittings and Labels required for four Solvent Bottles | N2600523 |

Liquid Chromatography Laboratory Bottle Kits

| Contents | Part No. |
|--|-----------------|
| 1x5 Liter Bottle with Cap and PTFE Insert, 2 Meters PTFE 1/8" Tubing and 1x10 µm SS Solvent Frit | N2601610 |
| 1x2 Liter Bottle with Cap and PTFE Insert 1 Meter PTFE 1/8" Tubing and 1x10 µm SS Solvent Frit | N2601611 |
| 1x1 Liter Bottle with Cap and PTFE Insert 1 Meter PTFE 1/8" Tubing and 1x10 µm SS Solvent Frit | N2601612 |
| 1x0.5 Liter Bottle with Cap and PTFE Insert 1 Meter PTFE 1/16" Tubing and 1x40 µm SS Solvent Frit | N2601613 |
| 1 Cap with PTFE Insert 1 Meter PTFE 1/8" Tubing and 1x10 µm SS Solvent Frit | N2601614 |
| 1 Cap with PTFE Insert 1 Meter PTFE 1/16" Tubing and 1x40 µm SS Solvent Frit | N2601615 |
| 1x0.5 Liter Bottle with Cap and Dual PTFE Insert 2 pcs of 2 Meter PTFE 1/8" Tubing (Piston Wash Function) | N2601616 |
| 1 Cap with Dual PTFE Insert 2 pcs of 2 Meter PTFE 1/8" Tubing and 1x10 µm SS Solvent Frit (Piston Wash Function) | N2601617 |

Replacement Vacuum Degasser Bottles

| Description | Part No. |
|------------------|-----------------|
| 1 L Glass Bottle | N2600497 |
| 2 L Glass Bottle | N2600498 |

Degassing Kits - Helium

Helium degassing solvent packages are available in a choice of three solvent configurations. Each kit contains a manifold, bottles, and all required tubing and fittings. The helium manifold has been designed to prevent accidental over-pressurization and to eliminate the possibility of solvent migrating back into the helium supply lines. The glass bottles supplied with the kits are specially coated to ensure safety and prevent solvent leakage if accidentally dropped or otherwise broken.

| Description | Part No. |
|--|-----------------|
| Isocratic Solvent Package Includes: one 2 L glass bottle kit, with cap assembly, and a helium manifold | N2600491 |
| Quaternary Solvent Package Includes: two 1 L glass bottle kits and two 2 L glass bottle kits, with cap assemblies, one helium manifold, and a solvent organizer accessory | N2600506 |

Degassing System Spares - Helium

| Description | Size | Part No. |
|--|---------|-----------------|
| 1 L Glass Bottle | | N2600497 |
| 2 L Glass Bottle | | N2600498 |
| 2 L Glass Bottle Kit | | N2600457 |
| 5 L Glass Bottle | | N2600499 |
| 5 L Glass Bottle Kit | | N2600458 |
| Autosampler Flush Bottle Kit | | N2600459 |
| Bottle Cap Assembly For 1 L and 2 L glass bottles. Includes: sparger (10 µm), solvent filter (10 µm), connecting fittings | | N2600495 |
| Bottle Cap Assembly For 5 L glass bottle | | N2600496 |
| Helium Manifold Kit 5 psi regulator | | N2600284 |
| Kel-F Ferrule | 1/8 in. | 09903771 |
| Tefzel Nut | 1/8 in. | N2601189 |

Supply Connectors - Helium

Each solvent reservoir system requires high-purity helium, either to pressurize or to degas the solvents. The helium pressure regulator with shut-off valve can deliver from 5 to 180 psi of pressure from an external tank. We offer all the fittings needed to connect a helium source to your solvent reservoir system. Refer to your operator's manual for step-by-step installation instructions.

| Description | Part No. |
|---|-----------------|
| 1 L Glass Bottle Reduces 1/4 to 1/8 in. | 09903906 |
| Regulator 5 to 180 psi with outlet shut-off valve | 00230090 |
| Teflon Tubing Helium and Solvent Supply, per 1 ft. length 1/8 in. o.d. x .06 in. i.d. | 02506483 |

SEALS, PISTONS, AND CHECK VALVES

Check valves, which include a sealing washer, are easy to install using the optional Torque Wrench kit. For all PerkinElmer pumps an intermediate check valve is required. The input check valve, which is identical, should be ordered.

| Description | Flexar LC or Series 200 (6000 psi) | | | | FX-10 |
|--|------------------------------------|------------------------------------|---------------------------------|------------------------------------|-------|
| | Standard Stainless Steel Part No. | Micropump Stainless Steel Part No. | Biocompatible Titanium Part No. | Micropump Stainless Steel Part No. | |
| 1 Standard High Pressure Piston Seal | 09908324 | 09923367† | 09907338 | 09923367† | |
| 1 High Pressure Piston with Seal - Chemically Resistant | 09907345 | | | | |
| 2 High Pressure Piston with Seal Backup Ring | 02542076 | † | 02542076 | † | |
| 3 High Pressure Piston Seal PTFE O-ring | 09902128 | 09902128 | 09902018 | 09902128 | |
| 4 Low Pressure Piston Seal | 09907339 | 09923366 | 09907339 | 09923366 | |
| 5 Low Pressure Piston Seal Backup Guide Bushing | 02542313 | N2915006 | N2061174 | N2915006 | |
| 6 High Pressure Piston | N2600124 | N2910511 | N2600124 | N2910511 | |
| 7 Low Pressure Piston | N2600104 | N2910512 | N2600104 | N2910515 | |
| 8 Intel Check Valve | 02540177 | 02540177 | N2600226 | 02540177 | |
| 9 Intermediate Check Valve | 02540177 | 02540177 | N2600226 | N2916052 | |
| 10 Outlet check Valve | 02540197 | 02540197 | N2600192 | 02540154 | |

* Refer to Users Manual for complete illustrated parts list

† High Pressure Piston Seal Backup ring (2) is included with the Standard High Pressure Piston Seal (1)

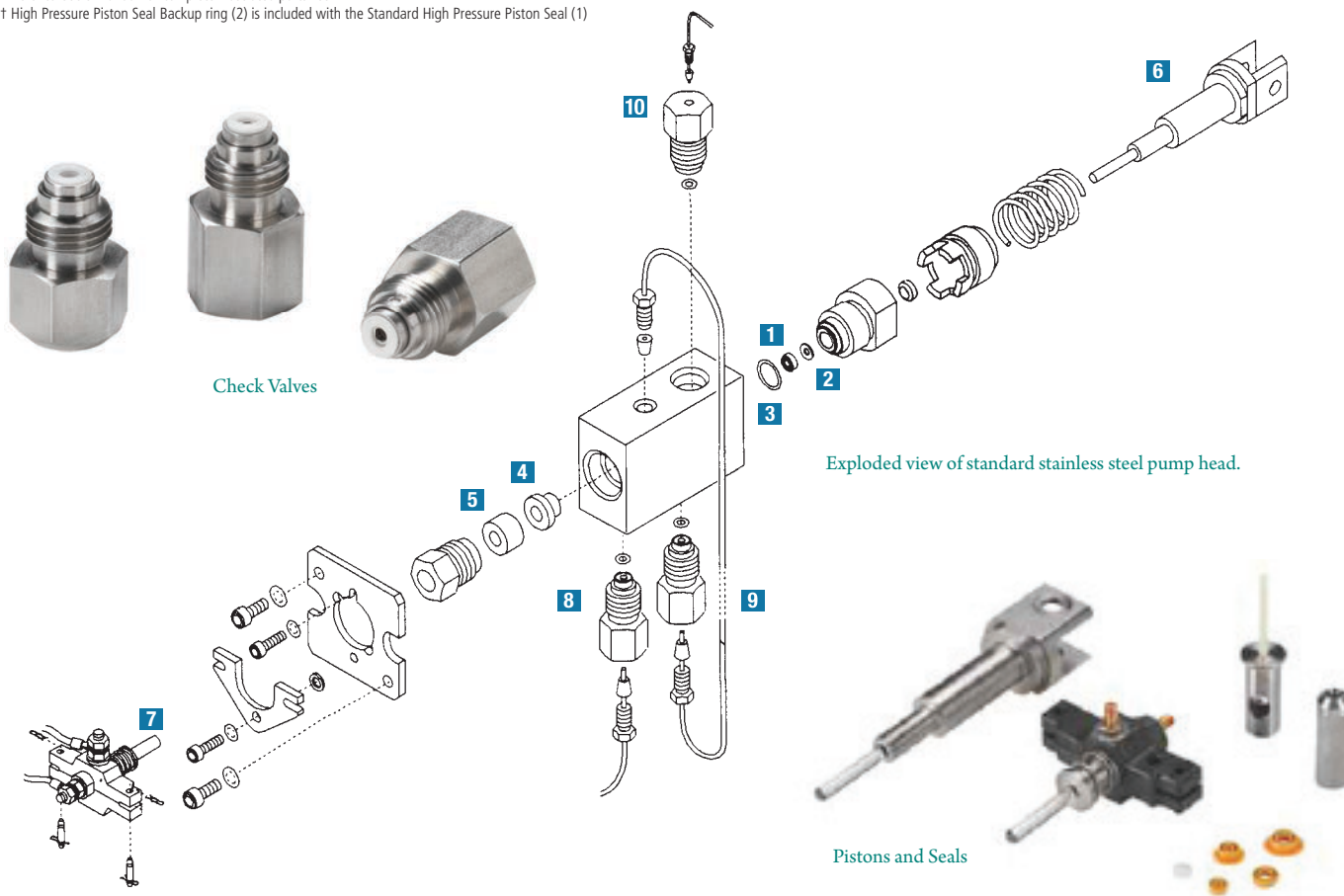

FLEXAR FX-15 & FX-20 PUMP HEAD

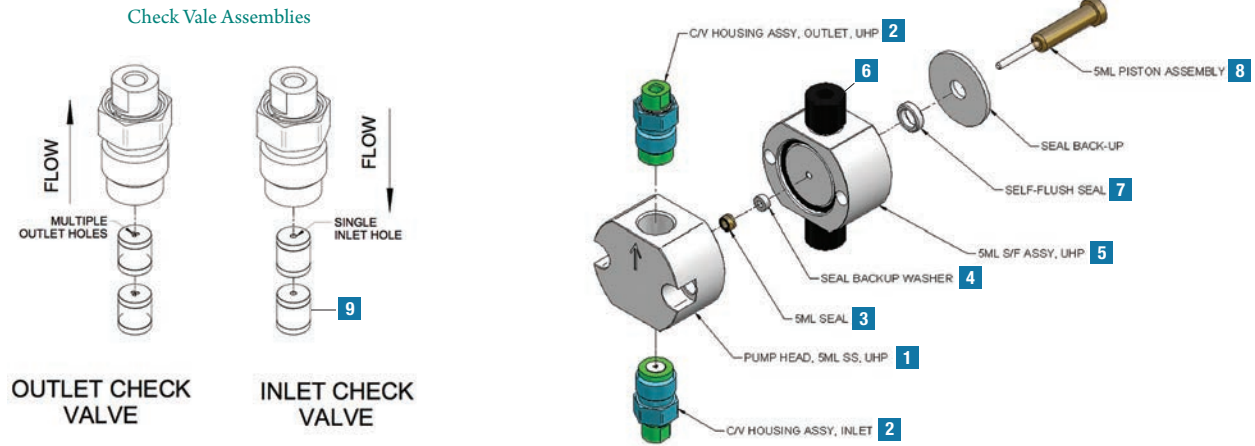

| Description | FX-15 | | FX-20 | |
|---|--------------------------|----------|--------------------------|------------------------|
| | Standard Stainless Steel | Part No. | Standard Stainless Steel | Biocompatible Titanium |
| 1 Pump Head (SS - 2 Pack, Titanium - Each) | † | | N2911251 | N2911244 |
| 2 Inlet/Outlet Check Valve Kit (1 inlet & 1 outlet) | N2911220 | | N2911220 | NA |
| 3 High Pressure Piston Seal | * | | * | * |
| 4 High Pressure Piston Seal Backup Washer | * | | * | * |
| 5 Self Flush Assembly w/ Seals | N2911235 | | N2911235 | N2911245 |
| 6 Self-Flush Check Valve Kit (1 inlet & 1 outlet) | N2911236 | | N2911236 | N2911236 |
| 7 Self-Flush Seal | * | | * | * |
| 8 Piston | N9308535 | | N9308535 | N9308535 |
| 9 Check Valve Capsule (SS - Each, Titanium - 4 Pack) | N2911239 | | N2911239 | N2911240 |
| 10 0.5 mm Tee Assembly Frit | N2911224 | | N2911224 | N2911241 |

* Seals sold in Kits only. See Preventive Maintenance and Seal Kits
 † Replacement with FX-20 pump heads (N2911251) is recommended.)

Preventive Maintenance (PM) and Seal Kits

| Description | Part No. |
|-------------------------------------|-----------------|
| FX-15 PM Kit Complete (4 Heads) | N2911249 |
| FX-15 Single Head Seal Kit (1 Head) | N2911221 |
| Fx-15 Heavy Duty HP Seals (1 Head) | N2918536 |
| FX-20 PM Seal Kit (4 Heads) | N2911250 |

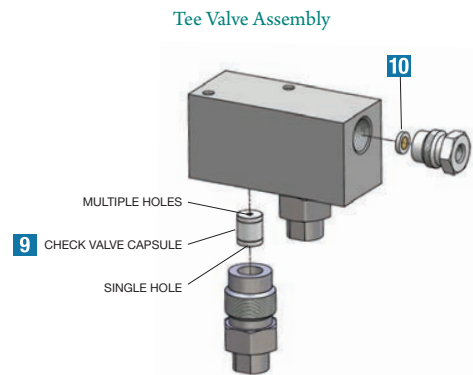

Bio Conversion Kit

For the Series 200 Pump and Series 200 Autosampler. The kit contains all of the parts necessary to convert the pump and the autosampler for Bio applications.

| Description | Part No. |
|--------------------|-----------------|
| Bio Conversion Kit | N2910035 |

Maintenance Kits and Tools

| Description | Part No. |
|--|-----------------|
| Biocompatible Piston Seal Replacement Kit Includes: four seals, backup rings, and O-Rings | N2910385 |
| Check Valve Torque Wrench | 02540871 |
| Diaphragm for Pulse Compensator | N2601316 |
| High Pressure Piston Seal Replacement Kit Includes: four seals, backup rings, and O-Rings | N2910383 |
| Insertion Tool | N2601503 |
| Micropump Piston Seal Replacement Kit | N2910384 |
| Pulse Compensator Repair Kit Includes: diaphragm, elastomer plug, and seal | N2600313 |
| Seal Removal Tool | N2601295 |
| Series 200 Bio LC Pump Maintenance Kit Includes: fuses, seals, O-Rings, and seal tools | N2910346 |
| Series 200 Pump Maintenance Kit Includes: fuses, seals, O-Rings, and seal tools | N2910345 |

Manuals and Accessories

| Description | Part No. |
|---|-----------------|
| Pump Backpressure Regulator (to generate backpressure for applications less than 250 psi) | 02540272 |
| Pump Priming Syringe (30 mL, plastic) | 09904849 |
| Series 200 Operator's Manual | 09938910 |
| Series 200 Pump Injector Bracket | N2910349 |

Solvent Sparger and Solvent Filters

Solvent filters remove unwanted particulate matter from the LC instrument. Spargers connect directly to the solvent delivery line and are easily removed for cleaning. The scavenger column is ideal for eliminating particulate material from solvents.



Solvent Filters

Solvent Spargers, Filters and Scavengers

| Description | Size | Part No. |
|--|-------|-----------------|
| Solvent Reservoir Sparger | | |
| Stainless Steel | 10 µm | 09903610 |
| Titanium | 10 µm | N2600070 |
| Stainless Steel | 40 µm | 09903615 |
| Titanium | 40 µm | N2600089 |
| Solvent Filters/Scavengers | | |
| In-Line Solvent Filter System | | 09903606 |
| In-Line Solvent Filter Replacement Kit | | 02540311 |
| In-Line Solvent Filter System, Titanium | | N2600259 |
| Replacement 2 µm Titanium Filter Element | | N2601477 |
| Replacement Seal for In-Line Solvent Filter | | N2601262 |
| 3 cm Scavenger Cartridge Holder | | 02580178 |
| Spheri-5 C18 10 µm Scavenger Column (5 pack) | | 02580202 |
| LC System Accessories | | |
| Solvent waste cup | | N2916019 |
| Drain Cup | | N2916085 |
| 90° Elbow Adapter, ¼" ID HDPP | | 09220102 |
| Tubing Clip (U-shaped, Polypropylene) | | NX598006 |
| Polypro Elbow Barbs | | 09220102 |
| Large ID (11 mm) Silicone Tubing (5 ft) | | N2916016 |
| Manual Injector Bracket (Magnetic Clip-on) | | N2931275 |

Pulse Compensators

The pulse compensator combines high-efficiency pulse smoothing with a low void volume. A Teflon diaphragm separates a reservoir filled by an RTV elastomer plug. Normal use will necessitate the eventual replacement of the diaphragm.

| Description | Part No. |
|---|-----------------|
| Diaphragm for Pulse Compensator | N2601316 |
| Pulse Compensator Repair Kit Includes: diaphragm, elastomer plug, and seal | N2601313 |

Series 200 Pump Solvent Upgrade Kits

The unique design of the PerkinElmer Series 200 Pump allows it to easily be upgraded for additional solvent capability right in your laboratory as your needs change. Installation of the kit by a PerkinElmer Service and Support is recommended, but not included. Contact your local PerkinElmer representative for more information.

| Description | Part No. |
|--|-----------------|
| Series 200 Binary to Quaternary Upgrade Kit | N2910344 |
| Series 200 Isocratic to Binary Upgrade Kit | N2910342 |
| Series 200 Isocratic to Quaternary Upgrade Kit | N2910343 |

Stainless Steel Sample Loops

For Flexar FX UHPLC Autosampler (up to 18,000 psi operation)

Stainless Steel loops required for use with FX-10 or FX-15 systems operating above 6,200 psi.

High Pressure Stainless Steel Sample Loops

| Description | Size | Part No. |
|-----------------|--------|-----------------|
| Sample Loop, SS | 2 µL | N2936071 |
| Sample Loop, SS | 5 µL | N2936056 |
| Sample Loop, SS | 10 µL | N2936057 |
| Sample Loop, SS | 20 µL | N2936058 |
| Sample Loop, SS | 50 µL | N2936059 |
| Sample Loop, SS | 100 µL | N2936060 |
| Sample Loop, SS | 200 µL | N2936061 |
| Sample Loop, SS | 500 µL | N2936062 |
| Sample Loop, SS | 1 mL | N2936063 |
| Sample Loop, SS | 2 mL | N2936064 |
| Sample Loop, SS | 5 mL | N2936065 |

PEEK Sample Loops

For Series 200/225 and Flexar LC Autosamplers (up to 6,200 psi operation)

These loops are compatible with all standard Flexar autosamplers as well as Series 225 autosamplers. PEEK loops cannot be used above 6,200 psi operation therefore are NOT compatible with standard Flexar autosamplers. Stainless steel loops required for use with FX-10 or FX-15 UHPLC systems operating above 6,200 psi.

| Description | Size | Part No. |
|------------------|--------|-----------------|
| PEEK Sample Loop | 2 µL | N2936072 |
| PEEK Sample Loop | 5 µL | N2936073 |
| PEEK Sample Loop | 10 µL | N2936074 |
| PEEK Sample Loop | 20 µL | N2936075 |
| PEEK Sample Loop | 50 µL | N2936076 |
| PEEK Sample Loop | 100 µL | N2936077 |
| PEEK Sample Loop | 250 µL | N2936078 |
| PEEK Sample Loop | 500 µL | N2936079 |
| PEEK Sample Loop | 1 mL | N2936080 |
| PEEK Sample Loop | 2 mL | N2936081 |
| PEEK Sample Loop | 5 mL | N2936082 |

Tubing Accessories

Clean-Cut™ tubing tool is designed to cut PTFE, Tefzel® and polymers in general but, in particular, PEEK tubing. A unique safety locking mechanism secures the blade when not in use.



| Description | Part No. |
|--|-----------------|
| Clean-Cut Tubing Cutter | ED020015 |
| Clean-Cut Tubing Replacement Blade | ED020016 |
| Cable/Tubing clip (U-Shaped) | NX598006 |
| Stick-on Tubing Organizer (Gray Plastic) | NX598006 |

PEEK Tubing

PEEK tubing has the strength required to withstand continuous use at HPLC pressure without swelling or bursting. Use PEEK with virtually any organic or inorganic liquid. PEEK tubing is not affected by halide salts, high-strength buffers or other aggressive mobile phases that degrade stainless steel.

| Description | Length | Part No. |
|--|--------|-----------------|
| 1/16 in O.D. x 0.007 in I.D. | 5 ft | N9302678 |
| 1/16 in O.D. x 0.010 in I.D. | 5 ft | N9302650 |
| 1/16 in O.D. x 0.004 in I.D. (Black) | 50 cm | N2916200 |
| 1/16 in O.D. x 0.005 in I.D. (Red) | 50 cm | N2916059 |
| Connector Tubing, Flexar/FX Mixer to Injector, SS | | N2916211 |
| Connector Tubing, Flexar ISO/Binary/Quaternary Pump to Autosampler, SS | | N2916210 |

Stainless Steel Tubing

Features and Benefits

- Pre-cut and mirror-polished in 316 stainless steel

SS-316 Tubing

| Description | Size | Part No. |
|-------------------------------|-------|-----------------|
| 1/16 in. o.d. x .043 in. i.d. | 6 ft | 00873035 |
| 1/16 in. o.d. x .015 in. i.d. | 6 ft | 00873036 |
| 1/16 in. o.d. x .007 in. i.d. | 3 ft | 02540838 |
| 1/16 in. o.d. x .007 in. i.d. | 20 cm | 02711441 |
| 1/16 in. o.d. x .007 in. i.d. | 50 cm | 00891480 |

Tefzel Tubing

| Description | Size | Part No. |
|-------------------------------|-------|-----------------|
| 1/16 in. o.d. x .030 in. i.d. | 10 ft | N9301029 |

High-performance Fingertight® fittings for the most demanding applications

This PEEK Fingertight® fitting is the toughest with regard to chemical resistance and pressure. This high-performance Fingertight® fitting is recommended for the most demanding applications and will resist pressures up to 6,000 psi (400 bar). Made from a single piece of PEEK, the size permits tightening without tools.

| Description | Part No. |
|-------------------------------------|----------|
| PEEK One-Piece Fingertight® Fitting | ED020005 |

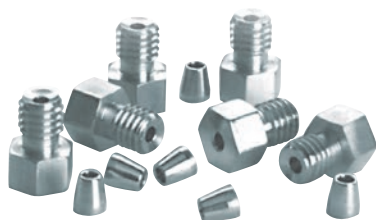

Fittings, Nuts and Ferrules

Stainless steel nuts are available in both Parker-Hannifin and Rheodyne™ formats. The nuts are used to connect 1/16 inch o.d. stainless steel tubing and feature a 10-32 thread size. PerkinElmer also offers select SSI fittings for 1/16 inch o.d. tubing in 1/4-28 thread size.

Stainless Steel Fittings

| Description | Part No. |
|--|----------|
| Kel-F Reverse Ferrule, 1/8 inch* | 09903771 |
| Kel-F Ferrule, 1/16 inch* | 09920382 |
| Tefzel Nut, 1/16 inch* | 09920381 |
| Parker-Hannifin Ferrule, 1/16 inch | 00873032 |
| Parker-Hannifin Nut, 1/16 inch | 09903980 |
| Parker-Hannifin Nut & Ferrule Kit, 1/16 inch Includes: 6 nuts and 6 ferrules | 00890945 |
| Parker-Hannifin Zero-Dead-Volume Union with nuts and ferrules | 09903289 |
| Parker-Hannifin Medium-Stem SS Nut | N2916202 |
| Rheodyne™ Ferrule, 1/16 inch | 09904947 |
| Rheodyne™ Nut, 1/16 inch long body | 09904974 |
| Rheodyne™ Nut, 1/16 inch short body | 09904956 |
| Rheodyne™ Nut and Ferrule Kit, 1/16 inch Includes: 6 ferrules, 3 short nuts and 3 long nuts | 02540274 |
| Tefzel Nut (for Reverse Ferrule), 1/8 inch* | N2601189 |
| Tefzel Nut, 1/16 inch* | 09920381 |
| Valco Ferrule | 09903891 |
| OptiTech Reusable Nut/Ferrule for UHPLC (fingertight to 15K psi) | N9306301 |
| OptiTech Ferrule replacements for UHPLC (10 pack) | N9306300 |
| UHPLC 1/16 inch Reusable Fitting | N9307800 |

* The Tefzel and Kel-F fittings above are only for low pressure use (under 400 psi).

ONE-PIECE, EASY-TO-USE



Fittings Kits

Recommended for users of a PerkinElmer Biocompatible LC system. Contains nuts, ferrules and unions.

| Description | Part No. |
|--------------------------------------|----------|
| Biocompatible Column Fittings for LC | N9301001 |

Fittings Kit for LC

The kit contains Rheodyne™ and SSI nuts and ferrules as well as Fingertight® II nuts and ferrules for toolless installation. Zero-dead-volume unions are also included. In addition, you receive varying lengths of stainless steel tubing in 0.007 and 0.010 inch i.d., as well as 0.30 inch i.d Tefzel® tubing.

| Description | Part No. |
|-------------------------|----------|
| All-in-one Fittings Kit | N9301002 |

Operation Kit

Recommended for purchasers of their first LC. Includes tubing, union, fittings, syringe, basic LC book and test mix.

| Description | Part No. |
|---------------|----------|
| Operation Kit | 00890873 |



Flom Analytical Injection Valve

The Flom Analytical Injection Valve is a very reliable manual HPLC injection valve. It comes with a built in "Inject" contact closure connection output. A PEEK rotor seal is provided for excellent solvent/sample resistance and the fluid path is designed for minimal dispersion. This valve is available in either stainless steel or PEEK, depending on the application or need.

| Description | Part No. |
|--------------------------------------|-----------------|
| Flom Injection Valve Stainless Steel | N9306073 |
| Flom Injection Valve PEEK | N9306072 |

Injector Valve Rotor Seals

For both Series 200 Autosampler and manual injectors.

For both the Rheodyne and Flom valves, rotor seals should be periodically replaced every 6 months to a year and are available in PEEK. For the Rheodyne valve, they are also available in Vespel. PEEK is more inert towards amines and other basic biomolecules/ pharmaceuticals, exhibiting less sample carryover. However, Vespel is somewhat more resilient than PEEK, providing somewhat better wear life.

| Description | Part No. |
|------------------------------------|-----------------|
| Flom Rotor Seal PEEK | N9306068 |
| Rheodyne 7725 Vespel Rotor Seal | 09904802 |
| Rheodyne 8125 Vespel Rotor Seal | 10070900 |
| Rheodyne 7725/9725 PEEK Rotor Seal | N9306044 |



Rheodyne™ 9725 PEEK Bio Injection Valve

Model 9725 is inert and well-suited to the chromatography of biological molecules, including applications with aggressive mobile phases. This valve is useful in all applications in which metal contact with the mobile phase and or sample should be avoided. This valve uses PEEK vent lines and a PTFE rotor seal and can be operated in a pH range from 0 – 14.

| Description | Part No. |
|---|-----------------|
| 9725 Injection Valve for Series 200 Autosampler | N9306020 |

Rheodyne™ 8125 Low-Dispersion Stainless Steel Injection Valve

Ideal for use in an LC/MS system, the model 8125 is designed for 1 and 2 mm microbore columns and can also be used with conventional analytical (3 to 5 mm) columns. Small flow passages produce low dispersion, maintaining the high mass sensitivity inherent in micro columns.

| Description | Part No. |
|---|-----------------|
| 8125 Low-Dispersion Stainless Steel Injection Valve | N9306021 |

Rheodyne™ 7725 Analytical Injection Valve

Inject from 1 µL to 5 mL with high accuracy and precision, with the Rheodyne™ 7725 and 7725i valves.

Rheodyne™ 7725 and 7725i valves are versatile injectors and can use both partial-filling and complete-filling methods for loading the sample loop. Wide port angles of the 7725/7725i valve provide improved access to fittings. Sample loop with a 2 µL internal capacity is also available. In a clean system, the 7725/7725i typically can make more than 30,000 injections before requiring replacement of the rotor seal.

| Description | Part No. |
|---|-----------------|
| 7725 Injection Valve for Series 200 Autosampler | N9306019 |
| 7725i Injection Valve with Internal Switch | N9306017 |

INJECT WITH GREATER PRECISION

Flexar Autosamplers

Best-in-class cycle time. Wide injection volume range. Excellent injection reproducibility. Precisely what you need to increase your sample throughput and efficiency.



Features and Benefits

- Injects sample volumes as little as 1 µL at pressures up to 18,000 psi with the FX UHPLC Autosampler
- Loads sample in only 8 seconds (in partial fill mode)
- Three injection modes: full loop, partial fill and µL-pickup with no sample waste
- Peltier cooling/heating mode option for operation at 4 °C to 40 °C. Will reach 4 °C ± 2 °C, achievable even at ambient temperatures up to 25 °C

All Flexar autosamplers can be upgraded in the field for Peltier cooling and heating. All Flexar autosamplers include:

- 100-sample tray
- 100 2 mL vials
- 100 2 mL screw top cap with cross slit vial septum
- Tubing to connect to waste reservoir
- I/O cable (Pump Start/Ready-In)
- Service Manager SW CD
- User's Manual
- Nuts and ferrules
- All fuses for 120–240 V
- All cables required for connection to a TotalChrom or Chromera Operating Environment

Flexar Autosamplers and Upgrade Kits

| Description | Part No. |
|--|-----------------|
| Flexar LC Autosampler | |
| High throughput autosampler with exceptionally low carryover. Operates up to 6,100 psi (420 bar). Provides flexible injection modes: full-loop, partial-fill and µL-Pickup (no sample waste). Peltier cooling and heating options available as field upgrades. Comes standard with 100 µL loop and 250 µL sample flush syringe. | N2930660 |
| Flexar Peltier LC Autosampler | |
| High throughput autosampler with exceptionally low carryover. Operates up to 6,100 psi (420 bar). Provides flexible injection modes: full-loop, partial-fill and µL-Pickup (no sample waste). Built-in Peltier cooling comes standard. Peltier heating option available as field upgrade. Comes standard with 100 µL loop and 250 µL sample flush syringe. | N2930661 |
| Flexar FX UHPLC Autosampler | |
| High throughput UHPLC autosampler with exceptionally low carryover. Operates up to 18,000 psi (1,241 bar). Provides flexible injection modes: full-loop, partial-fill and µL-Pickup (no sample waste). Built-in Peltier cooling comes standard. Peltier heating option available as field upgrade. Comes standard with 10 µL loop and 250 µL sample flush syringe. | N2930664 |
| Field Upgrade Peltier Kits | |
| Flexar and Series 225 Upgrade Kit (from standard to Peltier Cooling option) | N2930672 |
| Flexar and Series 225 Upgrade Kit (from standard to Peltier Cooling and Heating option) | N2930673 |
| Flexar and Series 225 Upgrade Kit (from Peltier Cooling to Peltier Cooling and Heating option) | N2930669 |

Flexar or Series 225/275 Autosampler Trays and Accessories

| Description | Part No. |
|--|-----------------|
| 25-Position 6 mL Vial Sample Tray | N2936045 |
| 80-Position 2 mL Vial plus (5) 6 mL Vial Tray (for derivatization) | N2936046 |
| 80-Position 2 mL Vial Tray with Dilution Tray | N2930676 |
| 96-well Microtiter Adapter | N9302562 |
| 96-well 'Deep-well' Microtiter Adapter | N9302560 |
| 96-well 7 mm Pre-slit Silicone Plate Mat/Seal | N9302555 |
| 96-well 'Deep' Microtiter Plate Adaptor (Supports Dual Microtiter Plates) | N2936048 |
| 96-well 'Shallow' Microtiter Plate Adaptor (Supports Dual Microtiter Plates) | N2936049 |
| 384-well Microtiter Adapter | N2936050 |
| 100-Position 2 mL Vial Sample Tray | N2936042 |
| (200) 0.2 mL Microvial plus (5) 2 mL Vial Tray | N2936043 |
| 250 µL Syringe Tip Replacements (10/pkg) | N2936003 |
| Flexar/225 Biocompatible Upgrade Kit (w/valve) | N2930675 |
| 1/16" OD x 0.038" ID PTFE Tubing (AS Transfer Line) | 02506495 |

Flexar Autosampler Valve Maintenance Parts

| Description | Flexar LC (6000 psi) Part No. | Flexar UHPLC (18000 psi) Part No. |
|-------------|-------------------------------|-----------------------------------|
| Rotor Seal | N2936021 | N2932001 |
| Stator | N2936022 | N2932002 |

| Description | Part No. |
|---|-----------------|
| NEW Flexar UHPLC (18000 psi) Autosampler Valve Upgrade Kit | N2932000 |
| Flexar Analytical LC (6000 psi) Autosampler Valve | N2936020 |

High Pressure Analytical Static Mixers

Static Mixers are important in facilitating complete mobile phase blending, resulting in improved retention performance. These mixers should be used as part of FX10, or FX15 LC systems, where high pressure blending is required. Mixers incorporate a highly efficient cross-flow shearing mechanism which produces vortex shear mixing over a wide range of volumes. They are now offered in 18,000 psi pressure max flavor.

A good first choice selection is a volume of about half the flow rate volume. For example, when pumping at a 0.5 mL/min flow rate, a 350 µL mixer provides good mixing with very good baseline stability.

| Description | Part No. |
|--|----------|
| 50 µL In-Line High Pressure Mixer Assembly, SS | N2911200 |
| 150 µL In-Line High Pressure Mixer Assembly, SS | N2911201 |
| 250 µL In-Line High Pressure Mixer Assembly, SS | N2911202 |
| 350 µL In-Line High Pressure Mixer Assembly, SS | N2911205 |
| 500 µL In-Line High Pressure Mixer Assembly, SS | N2911203 |
| 150 µL High Pressure Binary High Pressure Mixing-T, SS | N2911206 |
| 10 µL Binary Mixing-T, SS | N2911170 |
| Binary High Pressure T-Mixer, SS, 50 µL | N2911212 |
| Binary High Pressure T-Mixer, SS, 350 µL | N2911210 |
| Binary High Pressure T-Mixer, SS, 500 µL | N2911211 |
| T-connector, SS | N2911127 |

Syringes and Kits

PerkinElmer syringe kits for high pressure applications are manufactured for precise liquid delivery. All of these glass syringes come with precision stainless steel plungers. They are used for sampling and flushing and are available in a large variety of sizes.

Syringes

| Description | Part No. |
|---|----------|
| Sample Needle w/Fittings | N2936009 |
| Air Guide Needle (62 mm) | N2936000 |
| Bio Compatible Sample Needle w/Tubing Connector | N2936010 |
| Needle (80 mm) | N2936342 |
| Blunt Tip/Low Volume Needle | N2931199 |

Syringe Kits

| Dimension | Buffer Tubing | Part No. |
|-----------|---------------|----------|
| 100 µL | 200 µL | N2936051 |
| 250 µL | 500 µL | N2936052 |
| 500 µL | 1,000 µL | N2936053 |
| 1,000 µL | 2,000 µL | N2936054 |
| 2,500 µL | 2,000 µL | N2936055 |

FX-15, FX-20 UHPLC Pump Accessories

| Description | Part No. |
|--|----------|
| Replacement 0.5 µm Filter Frits for FX-15 (4-pack) | N2911224 |
| High Pressure FX-15 Piston Seal Kit (Need 4 per FX-15) | N2911221 |
| Piston Wash Bottle Kit | N2601616 |
| 2,500 µL Sample Syringe Starting Kit | N2930313 |

FX-10, FX-15 and FX-20 UHPLC System Accessories

| Description | Color | Size | Part No. |
|--|-------|-------|----------|
| ID PEEK Tubing | | | |
| 0.004" | Black | 50 cm | N2916200 |
| 0.005" | Red | 50 cm | N2916056 |
| 0.004" | Black | 76 cm | N2916260 |
| 0.005" | Red | 66 cm | N2916262 |
| Connector Tubing, Stainless Steel | | | |
| Flexar ISO/Binary/Quaternary Pump to Autosampler | | | N2916210 |
| Dual Mixer Connection (≤ 250 µL) | | | N2916216 |
| Dual Mixer Connection (≥350 µL) | | | N2916217 |
| FX-10 Pump A (Upper) to T-mixer | | | N2916213 |
| FX-10 Pump B (Lower) to T-mixer | | | N2916214 |
| FX-10 Purge Valve to Filter/Scavenger | | | N2916212 |
| FX-10 Injector to Column | | | N2916215 |
| FX-10 Pump A (Upper) to Dual Mixers | | | N2916218 |
| FX-10 Pump B (Lower) to Dual Mixers | | | N2916219 |
| FX-15 Pump to In-line Mixer | | | N2916222 |
| FX-15 Pump to Dual Mixers | | | N2916224 |
| FX-15 Injector to Column, Standard | | | N2916223 |
| FX-15 Injector to Column, 33 cm | | | N2916201 |
| 3 cm Scavenger Cartridge Holder | | | 02580178 |
| Spheri5 Scavenger Columns (5-pack) | | | 02580202 |
| 30 mL Priming Syringe | | | 09904849 |
| FX-15 C18 Scavenger Column Kit | | | N2910765 |
| FX-15 C18 Scavenger Columns (2/pkg) | | | 02580223 |

Microsyringes (For Manual Injection)

Syringes are used for accurate and precise liquid delivery. Each syringe is hand-fitted to assure maximum accuracy. Our syringes are composed of glass barrels and precision stainless steel needles. The needle features a blunt tip, required for use with a Rheodyne injector.

| Description | Part No. |
|--|----------|
| 10 µL Syringe | 09904937 |
| 25 µL Syringe | 09904823 |
| 50 µL Syringe | 09904941 |
| 100 µL Syringe | 09904822 |
| Rheodyne 22-gauge Blunt Needle with Luer Hub | 09904943 |

Rheodyne Valves Spare Parts

| Description | Model 9725 Part No. | Model 7725 Part No. |
|---|---------------------|---------------------|
| 1 Handle Screw | | |
| 2 Handle | | |
| 3 Knob Assembly | | |
| 4 Set Screws | | |
| 5 Needle Guide S200 Autosampler | N2931054 | N2931054 |
| Manual Valve ISS-100 | 09904800 | 09904800 |
| 6 Body | | |
| 7 Thrust Bearing | | |
| 8 Rotor Pin | | |
| 9 Seal Pins | | |
| 10 Needle Port Tube | 09904805 | 09904805 |
| 11 Bearing Ring | | |
| 12 Isolation Seal | | |
| 13 Rotor Seal Vespel | 09904802 | 09904802 |
| Tefzel | N9302677 | N9302677 |
| PEEK | N9306044 | N9306044 |
| 14 Stator Ring | | |
| 15 Stator Face Assembly PEEK and Ceramic | N9306047 | N9306047 |
| 16 Set Screws | | |
| 17 Stator PEEK | N9306046 | |
| Stainless Steel Titanium | | N9306045 |
| 18 Stator Screws | | |

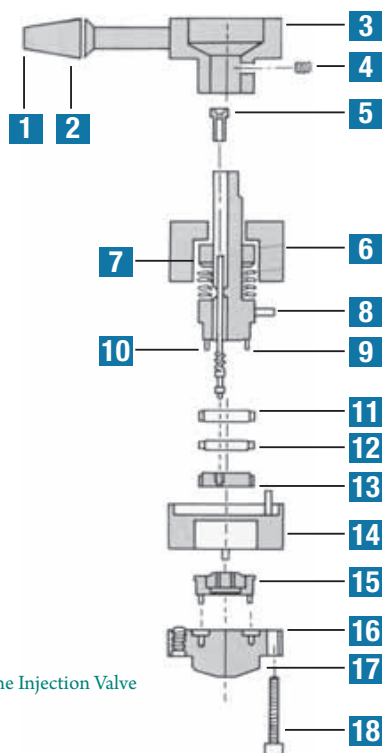

Rheodyne Injection Valve

PEEK Sample Loops for Rheodyne Valves

PEEK Sample Loops avoid many of the problems associated with stainless steel sample loops. Metal loops will often absorb sample components resulting in inaccurate quantitative results. In addition, metal loops may be corroded by high-salt buffers and chloride salts. Sample Loops are made from PEEK tubing and fittings. PEEK (Poly-Ether-Ether-Ketone) is a mechanically strong, chemically inert polymer ideal for HPLC applications where metal surfaces may interact with mobile phase or sample components.

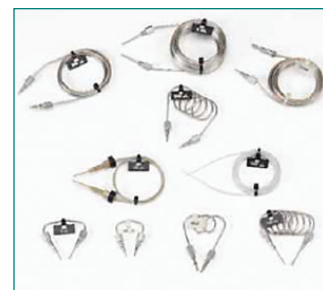

Sample Loops

Each Sample Loop is supplied with two PEEK hex-head nuts and ferrules. These fittings grip the tubing in two locations for a more reliable connection.

| Description | Model 9725 Part No. |
|-------------------------|---------------------|
| 5 µL PEEK Sample Loop | N9306033 |
| 10 µL PEEK Sample Loop | N9306034 |
| 20 µL PEEK Sample Loop | N9306035 |
| 50 µL PEEK Sample Loop | N9306036 |
| 100 µL PEEK Sample Loop | N9306037 |
| 200 µL PEEK Sample Loop | N9306038 |
| 500 µL PEEK Sample Loop | N9306039 |
| 1 mL PEEK Sample Loop | N9306040 |
| 2 mL PEEK Sample Loop | N9306041 |
| 5 mL PEEK Sample Loop | N9306042 |

SS Loop for model 7725

| Description | Model 7725 Part No. |
|------------------------------------|---------------------|
| 5 µL Stainless Steel Sample Loop | N9306023 |
| 10 µL Stainless Steel Sample Loop | N9306024 |
| 20 µL Stainless Steel Sample Loop | N9306025 |
| 50 µL Stainless Steel Sample Loop | N9306026 |
| 100 µL Stainless Steel Sample Loop | N9306027 |
| 200 µL Stainless Steel Sample Loop | N9306028 |
| 500 µL Stainless Steel Sample Loop | N9306029 |
| 1 mL Stainless Steel Sample Loop | N9306030 |
| 2 mL Stainless Steel Sample Loop | N9306031 |
| 5 mL Stainless Steel Sample Loop | N9306032 |

Note: Loops are compatible with both manual valves and Series 200 Autosampler valves.

Internal Loop for Models 7725/9725

| Description | Part No. |
|-------------------------|----------|
| 2 µL (PEEK and Ceramic) | N9306022 |

Peltier Tray Accessories

100-Position Peltier Temperature-Controlled Tray Accessory

100 standard 2 mL vials. Temperature controlled from 4 - 60 °C within ± 1 °C directly from Autosampler keypad – or from TotalChrom Workstation – Client/Server.

| Description | Part No. |
|--|-----------------|
| 100-Position Peltier Temperature-Controlled Tray Accessory | N2930035 |



Double Microtiter Peltier Temperature-Controlled Tray Accessory

Two shallow or medium depth microtiter plates. Temperature controlled from 4 - 60 °C within ± 1 °C directly from Autosampler keypad – or from TotalChrom Workstation – Client/Server. (Also requires N2930036).

| Description | Part No. |
|---|-----------------|
| Double Microtiter Peltier Temperature-Controlled Tray Accessory | N2930037 |

Peltier Temperature Controller

Controller Unit required for operation of either 100-position or Double Microtiter Peltier trays.

| Description | Part No. |
|--------------------------------|-----------------|
| Peltier Temperature Controller | N2930036 |

Series 200 Autosampler Microtiter Trays and Plates

If you need high throughput and high speed, the Series 200 is designed for injecting up to 225 samples at rates as fast as two to three injections per minute from any sample position – ideal for LC/MS work. The Series 200 even supports direct injections from microtiter plates – shallow or deepwell format.

| Tray Description | Part No. |
|--|-----------------|
| Double Deep Microtiter Tray (Holds two 96-well Plates) | N2930147 |
| Double Microtiter Peltier Tray Requires Peltier Controller (N2930036) (Holds two 96-well Plates) | N2930037 |
| Double Shallow Microtiter Plate Tray (Holds two 96-well Plates) | N2930146 |
| Peltier Tray for 384-well Microtiter Plates Requires Peltier Controller (N2930036) and Series 200 Autosampler Firmware 1.08 or higher. | N2930038 |



| Description | Part No. |
|--|-----------------|
| 100-Position Peltier Temperature-Controlled Tray Accessory | N2930035 |

Sample Trays

PerkinElmer has researched, engineered, and developed the Series 200 Autosampler to ensure precision, flexibility, reliability, and ease-of-use.

Our unique XYZ design allows you to take advantage of the built-in “extra” capabilities including dilution, derivatization, and standard addition – all without additional hardware or cost.

| Description | Part No. |
|--|-----------------|
| 25-Position Sample Tray | N2930040 |
| 80-Position Sample Tray, Dilution (with tank) | N2930314 |
| Includes: 80-Position Tray Only | N2930044 |
| Glass Diluent Tank Only | B0505677 |
| 85-Position Sample Tray, Derivatization | N2930041 |
| 100-Position Sample Tray | N2931097 |
| 205-Position Sample Tray, Microvials/10 standard vials | N2930042 |
| 225-Position Sample Tray, Microvials/high throughput | N2930043 |

| Microtiter Plates Description | Part No. |
|-------------------------------|-----------------|
| 96-well Deep (1mL) | N9302560 |
| 96-well Plate Cover/Mat | N9302563 |
| 96-well Shallow (200 µL) | N9302562 |
| 96-well Mid (500 µL) | N9302561 |
| 96-well Plate Cover/Mat | N9302563 |
| 96-well Shallow (200 µL) | N9302562 |
| 96-well Mid (500 µL) | N9302561 |
| 96-well Plate Cover/Mat | N9302563 |
| 384-well Plate (200 µL) | N9302564 |
| 384-well Plate Cover/Mat | N9302565 |

SUPPLIES AND ACCESSORIES

UHPLC – General Starter Kit

| Description | | Part No. |
|--|----------|-----------------|
| UHPLC – General Starter Kit | | N2930801 |
| Contents | Qty/Pack | Part No. |
| Open-End Wrench | 2 | 09907233 |
| Adjustable Wrench | 1 | N9301326 |
| Reversible Screw Driver | 1 | N9301480 |
| Parker-Hannifin ZDV SS Union | 1 | 09903289 |
| Parker-Hannifin Medium-Stem SS Nuts | 10 | 09903980 |
| 1/16" Parker-Hannifin SS Ferrules | 10 | 00873032 |
| 1/16" Valco SS Ferrules | 6 | 09903891 |
| Finger-Tight Fittings, PEEK, 5.5K psi Max. (5/pk) | 1 | N9307822 |
| Optimize Technologies EZP (Hand-Tight Fitting to 13K psi, Wrench-tight to 20K psi) | 1 | N9306301 |
| 1/16" Tefzel Nuts | 2 | 09920381 |
| 1/16" Tefzel Reverse Ferrules | 2 | 09920382 |
| 1/8" Tefzel Nuts | 4 | N2601189 |
| 1/8" Tefzel Reverse Ferrules | 4 | 09903771 |
| PEEK Tubing Cutter (Includes 5 Extra Blades) | 1 | N9307820 |
| 50 cm x 0.005" ID 1/16" SS Tubing | 3 | 02507060 |
| 5' x 0.004" ID 1/16" PEEK Tubing, Black | 1 | N2916261 |
| 5' x 0.005" ID 1/16" PEEK Tubing, Red | 1 | N2916262 |
| 30 mL Priming Syringe | 1 | 09904849 |
| 2 mL Clear Write-On Vials w/10 mm Pre-Slit PTFE/Silicone Caps; 100/pk | 1 | N9300695 |
| Cable/Tubing Organizer Clip | 3 | NX598006 |

HPLC – General Starter Kit

| Description | | Part No. |
|---|----------|-----------------|
| HPLC – General Starter Kit | | N2930802 |
| Contents | Qty/Pack | Part No. |
| Open-End Wrench | 2 | 09907233 |
| Adjustable Wrench | 1 | N9301326 |
| Reversible Screw Driver | 1 | N9301480 |
| Parker-Hannifin ZDV SS Union | 1 | 09903289 |
| Parker-Hannifin Medium-Stem SS Nut | 10 | 09903980 |
| 1/16" Parker-Hannifin SS Ferrule | 10 | 00873032 |
| 1/16" Valco SS Ferrules | 6 | 09903891 |
| Rheodyne SS Nut, Short Stem | 2 | 09904956 |
| Rheodyne SS Nut, Long Stem | 2 | 09904974 |
| 1/16" Rheodyne SS Ferrule | 4 | 09904947 |
| 1/16" Tefzel Nuts | 2 | 09920381 |
| 1/16" Tefzel Reverse Ferrules | 2 | 09920382 |
| 1/8" Tefzel Nuts | 4 | N2601189 |
| 1/8" Tefzel Reverse Ferrules | 4 | 09903771 |
| Finger-Tight Fittings, PEEK, 4K psi Max. | 6 | 09920513 |
| PEEK Tubing Cutter (Includes 5 Extra Blades) | 1 | N9307820 |
| 50 cm x 0.005" ID 1/16" SS Tubing | 1 | 02507060 |
| 50 cm x 0.007" ID 1/16" SS Tubing | 2 | 00891480 |
| 5' x 0.007" ID 1/16" PEEK Tubing, Yellowish-Tan | 1 | N9302650 |
| 5' x 0.005" ID 1/16" PEEK Tubing, Red | 1 | N2916262 |
| 30 mL Priming Syringe | 1 | 09904849 |
| 2 mL clear write-on vials w/10 mm Pre-Slit PTFE/Silicone Caps; 100/pk | 1 | N9300695 |
| Cable/Tubing Organizer Clip | 3 | NX598006 |

Autosampler Syringes

| Description | Pkg. | Part No. |
|---|---------|------------------|
| Sampling Syringe | 50 µL | 09923304 |
| Sampling Syringe | 100 µL | 09923305 |
| Sampling Syringe | 250 µL | 09923270 |
| Sampling Syringe | 500 µL | 09923306 |
| Sampling Syringe | 1000 µL | 09923307 |
| Sampling Syringe | 2500 µL | 09923219* |
| Sampling Syringe Kit 2500 µL (includes 2500 µL syringe, union and tubing kit) | 2500 µL | N2930313 |
| Flush Syringe | 2500 µL | 09923219 |

*Requires one-time purchase of N2930313



EVO N₂ Nitrogen Generators

Technical Specifications for EVO N₂ Nitrogen Models

| Description | Specification |
|-----------------------------|---|
| Purity | > 98% (less 2% O ₂) |
| Outlet Pressure | 8 bar / 120 psi |
| Height | 64.1 cm (25.2 in) |
| Width | 48.2 cm (19 in) |
| Depth | 83.5 cm (32.9 in) |
| Weight | 121 kg (266 lbs) |
| Operating Temperature | +10 °C to +40 °C (+50 °F to +104 °F) |
| Operating Relative Humidity | 0 – 80 % rF, no condense / 0 – 99% rF with condense drain |
| Power Consumption | 1300 Watt |
| Circuit Breaker | 10A for 230V ; 15A for 110V |
| Heat Dissipation | Approx 2700 Btu/h |

| Flow Rate | Voltage | Part No. |
|-----------|---------|-----------------|
| 25 L/min | 115V | N9308587 |
| | 220V | N9308573 |
| 35 L/min | 115V | N9308588 |
| | 220V | N9308574 |
| 60 L/min | 115V | N9308589 |
| | 220V | N9308575 |



EVO N₂ Hybrid Nitrogen Generators

The EVO Nitrogen hybrid gas generators was specifically designed to meet the flow, purity and pressure requirements of the LC/MS of AB SCIEX with appropriate pressures and flows of nitrogen. The simple and proven pressure swing adsorption (PSA) technology is employed to remove Nitrogen from compressed air. Selective molsieves (CMS) adsorb remaining Oxygen and traces of humidity.

Technical Specifications for EVO N₂ Hybrid Nitrogen Models

| Description | Specification |
|-----------------------------|---|
| Purity | > 99.5% (less 2% O ₂) |
| Outlet Pressure | 8 bar / 120 psi |
| Height | 64.1 cm (25.2 in) |
| Width | 48.2 cm (19 in) |
| Depth | 83.5 cm (32.9 in) |
| Weight | 121 kg (266 lbs) |
| Operating Temperature | +10 °C to +40 °C (+50 °F to +104 °F) |
| Operating Relative Humidity | 0 – 80 % rF, no condense / 0 – 99% rF with condense drain |
| Power Consumption | 1300 Watt |
| Circuit Breaker | 10A for 230V ; 15A for 110V |
| Heat Dissipation Approx | 2700 Btu/h |

| Flow Rate | Voltage | Part No. |
|--|---------|-----------------|
| Up to 10 L/min +/- 1.5 L/min (at atmospheric pressure) | 115V | N9308590 |
| | 220V | N9308576 |

N₂ Whisper Generators

The Whisper nitrogen generator has been developed to meet specific requirements in terms of flow, purity and pressure in LC/MS applications. It can also be used for the evaporation of solvents in samples being analyzed. The simple high efficiency membrane technology allows nitrogen separation from other air components present within the supplied compressed air.

Better results from analytical instruments: The constant purity of nitrogen improves system stability and ensures reproducible results.

Better lab efficiency: Gas cylinders are insufficient to ensure the large nitrogen volumes needed in LC/MS techniques.

Cost savings: Initial investment can normally be paid back in less than a year. No plumbing is required to transfer gas from the storeroom to the lab.

Improved safety: Nitrogen produced at low pressure and room temperature eliminates the risks related to high pressure gas bottle use and the hazards associated with liquid nitrogen.

Simple installation: The Whisper nitrogen generator is very easy to install. Simply plug the unit into a 200V 60Hz/50Hz outlet. The exclusive "Split System" design allows the section containing the compressor to be installed separately from the nitrogen production assembly, which can be wall-mounted to save precious space!

Technical Specifications

| Description | Specification |
|-------------------------------|---|
| Purity (based on outlet flow) | > 98 - 99.5% |
| Outlet Pressure | 7 bar |
| Height | 115 cm (45.3 in) |
| Width | 48 cm (19 in) |
| Depth | 26 cm (10.2 in) |
| Weight | 15 kg (33 lbs) ; 18 kg (39 lbs); 21 kg (46 lbs) |
| Operating Temperature | +10 °C to +35 °C (+50 °F to +95 °F) |
| Air Compressor Supplied | NO |
| Electrical Requirements | None |
| Background Noise | None |
| Connections | 1/4 G |

| Flow Rate | Part No. |
|-----------|-----------------|
| 40 L/min | N9306285 |
| 80 L/min | N9306286 |
| 120 L/min | N9306287 |



N₂ Mini Whisper Generators

The Mini Whisper Nitrogen generator has been developed to meet specific requirements in terms of flow, purity and pressure on some LC/MS interfaces as well as on light scattering evaporative detector.

The simple high efficiency membrane technology allows the separation of Nitrogen from the other components of the compressed air inlet.

The low pressure drop allows the unit to be connected to an existing dry and oil-free compressed air source in the lab.

Technical Specifications

| Description | Specification |
|-------------------------------|-------------------------------------|
| Purity (based on outlet flow) | > 98 - 99.5% |
| Outlet Pressure | 7 bar |
| Height | 73.5 cm (28.9 in) |
| Width | 34.8 cm (13.7 in) |
| Depth | 35 cm (13.8 in) |
| Weight | 8 kg (18 lbs) |
| Operating Temperature | +10 °C to +35 °C (+50 °F to +95 °F) |
| Air Compressor Supplied | NO |
| Electrical Requirements | None |
| Background Noise | None |
| Connections | 1/4 G |

| Flow Rate | Part No. |
|-----------|-----------------|
| 8 L/min | N9306288 |

Parker Domnick Hunter Nitrogen Generators

PerkinElmer offers customers a new line of nitrogen generators to meet the growing need for cost effective and pure nitrogen. Membrane Nitrogen Generators are designed to supply single or multiple LC/MS instruments with dry nitrogen at purities of 98% to 99.5%. The generator can also be used for solvent evaporation as well as supplying dry nitrogen to analytical instruments.

Nitrogen is produced by utilizing a combination of filtration and membrane separation technologies. A high efficiency pre-filtration system pre-treats the compressed air to remove all contaminants down to 0.01 micron. Hollow fiber membranes subsequently separate the clean air into a concentrated nitrogen output stream and an oxygen enriched permeate stream, which is vented from the system. The combination of these technologies produces a continuous on demand supply of pure nitrogen.



Technical Specifications

| Description | Low Flow NitroFlow Lab | N2-22 Mid Flow | N2-35 Mid Flow | N2-45 High Flow |
|------------------------------|--|--|--|--|
| Purity | 94.0 - 99.5% | 95.0 - 99.5% | 95.0 - 99.5% | 95.0 - 99.5% |
| Min./Max. Operating Pressure | 8 bar | 60/145 psig (4.0/10 barg) | 60/145 psig (4.0/10 barg) | 60/145 psig (4.0/10 barg) |
| Height | 70 cm (27.6 in) | 13 cm (5.1 in) | 13 cm (5.1 in) | 140 cm (55.1 in) |
| Width | 90 cm (35.4 in) | 45 cm (17.8 in) | 45 cm (17.8 in) | 61 cm (24.0 in) |
| Depth | 31 cm (12.2 in) | 41 cm (16.1 in) | 41 cm (16.1 in) | 50 cm (20.0 in) |
| Weight | 127.4 kg (280 lbs) | 36 kg (80 lbs) | 41 kg (90 lbs) | 114 kg (250 lbs) |
| Operating Temperature | +10 °C to +35 °C (+50 °F to +95 °F) | +15 °C to +35 °C (+60 °F to +95 °F) | +15 °C to +35 °C (+60 °F to +95 °F) | +15 °C to +35 °C (+60 °F to +95 °F) |
| Electrical Requirements | 120 V / 60 Hz, 20 Amp Nema 5 | None | None | None |
| Air Compressor | Yes | No | No | No |
| Flow Rates | 10 - 50 lpm | 100 psi inlet - 13 lpm output - 99.5% purity 125 psi inlet - 16 lpm output - 99.5% purity | 100 psi inlet - 20 lpm output - 99.5% purity 125 psi inlet - 25 lpm output - 99.5% purity | 100 psi inlet - 39 lpm output - 99.5% purity 125 psi inlet - 55 lpm output - 99.5% purity |
| | | 100 psi inlet - 20 lpm output - 99.0% purity | 100 psi inlet - 30 lpm output - 99.0% purity | 100 psi inlet - 53 lpm output - 99.0% purity |
| | | 125 psi inlet - 25 lpm output - 99.0% purity | 125 psi inlet - 37 lpm output - 99.0% purity | 125 psi inlet - 74 lpm output - 99.0% purity |
| | | 100 psi inlet - 30 lpm output - 98.0% purity | 100 psi inlet - 45 lpm output - 98.0% purity | 100 psi inlet - 73 lpm output - 98.0% purity |
| | | 125 psi inlet - 38 lpm output - 98.0% purity | 125 psi inlet - 57 lpm output - 98.0% purity | 125 psi inlet - 106 lpm output - 98.0% purity |
| Part No. | N9306213 (120V) N9306214 (230V) | N9306210 | N9306211 | N9306212 |

LC/MS Nitrogen Generators with Integrated Compressors

| Description | Specification |
|--------------------------------|--------------------|
| Purity | >98% |
| Min. / Max. Operating Pressure | 101.5 psi/g |
| Height | 70.1 cm (27.8 in) |
| Width | 51.1 cm (20.1 in) |
| Depth | 58.2 cm (22.9 in) |
| Weight | 135.2 kg (298 lbs) |

| Description | Specification |
|-------------------------|--|
| Operating Temperature | +5 °C to +40 °C (+41 °F to +104 °F) |
| Port Connection Outlet | 1/4" Compression Fitting |
| Electrical Requirements | 120 V / 60 Hz or 230 V / 50-60 Hz ± 10% |
| Air Compressor | Yes |
| Flow Rates | 30 L/min |
| Part No. | N9303223 (120V) ; N9303224 (230V) |

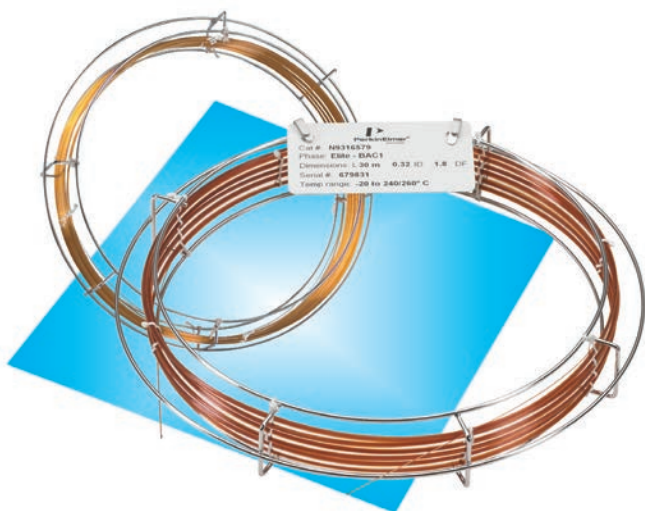

Why choose fused silica?

Many factors influence the quality of a column. Fused silica is considered to be the purest form of glass, with fewer metal oxides (Lewis acid sites) and hydrogen bonding (surface silanol) groups. The stationary phase is cross linked (polymerized) and also bonded to the surface of the column to provide a high degree of stability, resulting in lower bleeding of the stationary phase at elevated temperatures. The superior inertness of the column means that acidic and basic compounds can be analyzed on the same column.

Selecting the right Stationary Phase

The inherent efficiency (large number of theoretical plates) of capillary columns allows you to choose from relatively few types of phases, compared to the many varieties of packed columns previously required. Perhaps more importantly, because capillary columns are more efficient, you will see superior resolution resulting in narrower, taller peaks that allow easier integration from your data system. Identification of small peaks are facilitated by a reduced baseline bleed and lower baseline noise. Non-polar Elite-1 columns from PerkinElmer will preferentially retain non-polar compounds, whereas the PerkinElmer Elite-200 column phase provides high selectivity for analytes containing lone pair electrons, such as nitro and carbonyl groups. Elite-WAX polyethylene glycol columns are highly selective toward polar compounds such as alcohols.

What length do I need?

Typically capillary columns are available in lengths from 15 to 105 meters. The longer the column the more resolving power, but this also increases the analysis time. Doubling a column length only increases resolution by approximately 40%. Under isothermal conditions, the analysis time will double if using temperature programmed analysis retention times are more dependent on the temperature than on the column length. PerkinElmer provides columns in the most popular lengths of 5, 10, 12, 15, 25, 30, 50, 60, 75, 100 and 105 meters depending upon the column i.d.

FINEST QUALITY HIGH-STRENGTH FUSED SILICA

Quick Phase Cross Reference Chart*

| Phase/Description | Equivalent Capillary Phase |
|---|--|
| Elite-1, Elite-1ht 100% Dimethyl | DB-1, DB-1ht, HP-1, HP-101, Ultra-1, SPB-1, CP-Sil 5CB, CI-Sil5CBMS, RSL-150, RSL-160, Rtx-1, BP-1, CB-1, OV-1, 007-1MS, SP-2100, SE-30 |
| Elite-200 Trifluoropropylmethyl | DB-210, AT-210, VF-200MS, 007-210, Rtx-200 |
| Elite-5, Elite 5ms, Elite -5ht 5% Diphenyl – 95% Dimethyl | DB-5, DB-5ms, DB-5ht, Ultra-2, SPB-5, CP-Sil8CB, RSL-200, Rtx-5, BP-5, CB-5, OV-5, 007-2(MPS-5), SE-52, SE-54, XTI-5, Rtx-5ms, PTE-5, HP-5ms |
| Elite-5Amine 5% Diphenyl – 95% Dimethyl Polysiloxane | PTA-5 |
| Elite-35, Elite-35ms 35% Phenyl – 65% Methyl | DB-35, DB-35ms, Rtx-35, SPB-35, AT-35, Sup-Herb |
| Elite-17, Elite-17ms, Elite-17ht 50% Phenyl – 50% Methyl | DB-17, DB-17ht, HP-17, RSL-300, Rtx-50, 007-17(MPS-50), SP-2250, HP-50+ |
| Elite-1301 6% Cyanopropylphenyl | DB-1301, Rtx-1301, CP-624 |
| Elite-1701 14% Cyanopropylphenyl – 86% Dimethyl | DB-1701, SPB-7, CP-Sil 19CB, Rtx-1701, BP-10, CB-1701, OV-1701, 007-1701 |
| Elite-225 50% Cyanopropylphenyl – 50% Phenyl methyl | DB-225, HP-225, SP-2330, CP-Sil 43CB, RSL-500, Rtx-225, BP-225, CB-225, OV-225, 007-225 |
| Elite-WAX Polyethylene Glycol | DB-FFAP, HP-20M, SUPELCOWAX 10, CP-WAX 52CB, SUPEROX II, CB-WAX, STABILWAX, BP-20, Elite-CW 007-CW, Carbowax, HP-Innowax |
| Elite-FFAP Polyethylene Glycol – Acid Modified | DB-WAX, HP-FFAP, NukoI, SUPEROX FA, STABI LWAX-DA, 007-FFAP, OV-351, DB-FFAP |
| Elite-608 Specialty phase for semi-volatile pesticides (EPA 608) | SPB-608, NON_PAKD Pesticide, DB-608, 007-608, HP-608 |
| Elite-624, Elite-Volatiles Volatiles, Specialty phase for volatiles | DB-624, DB_VRX, VOCOL, NONPAKD AT-624, Rtx-Rtx-502.2, 007-624, HP-624, CP-624, Rtx-624 |
| Elite-CLPesticides Specialty Phase for Chlorinated Pesticides | Rtx-CLPesticides |
| Elite-VMS Specialty Phase for Volatile Organics on GC/MS | Rtx-VMS |
| Elite-PONA Dimethyl polysiloxane processed for the detailed analysis of petroleum naphtha | DB-Petro100, Petrocol DH, HP-PONA, SPB-1, 007-1, Rtx-1PONA |

* For a more detailed cross reference chart, see page 174-175.

PROTECTION WITHOUT THE CONNECTION

Innovative Integrated Guard Columns

Integrated Guard columns: guard columns WITHOUT connections — protecting your analytical column has never been this easy!

Features and Benefits

- No leaks for a more robust method
- No column connections for easier, faster maintenance
- No peak distortions due to connector dead volume and thermal capacity

For analysts who find it inconvenient to make a leak-free connection between the guard column and the analytical column, we offer Integrated Guard columns. These innovative columns incorporate both guard column and analytical column in a continuous length of tubing, eliminating the connection and all connection-associated problems! The guard column section is marked separately from the analytical column, using high-temperature string.

The Integrated Guard column is so economical that we challenge you to compare our price against that of a conventional connection, even if you assemble it yourself.

Elite-1

| ID | df (mm) | Temp Limits (°C) | Integra-Guard | 30 m Part No. |
|---------|---------|------------------|---------------|------------------|
| 0.25 mm | 0.25 | -60 to 330/350 | 5 m | N9305600 |
| 0.53 mm | 1.00 | -60 to 330/350 | 5 m | N9305601 |
| | 5.00 | -60 to 340/360 | 5 m | N9305602 |

Elite-5

| ID | df (mm) | Temp Limits (°C) | Integra-Guard | 30 m Part No. | 60 m Part No. |
|---------|---------|------------------|---------------|------------------|------------------|
| 0.25 mm | 0.25 | -60 to 330/350 | 5 m | N9305603 | |
| | 0.25 | -60 to 330/350 | 10 m | N9305604 | |
| | 1.00 | -60 to 330/350 | 5 m | N9305605 | |
| 0.32 mm | 0.25 | -60 to 330/350 | 5 m | N9305606 | N9305607 |
| | 1.00 | -60 to 330/350 | 5 m | N9305608 | |
| 0.53 mm | 5.00 | -60 to 340/360 | 5 m | N9305609 | |

Elite-5 ms II

| ID | df (mm) | Temp Limits (°C) | Integra-Guard | 15 m Part No. | 30 m Part No. |
|---------|---------|------------------|---------------|------------------|------------------|
| 0.25 mm | 0.10 | -60 to 330/350 | 5 m | | N9305610 |
| | 0.25 | -60 to 330/350 | 5 m | N9305611 | N9305612 |
| | 0.25 | -60 to 330/350 | 10 m | | N9305613 |
| 0.50 | 0.50 | -60 to 330/350 | 5 m | | N9305614 |
| | 0.50 | -60 to 330/350 | 10 m | N9305615 | N9305616 |
| 0.32 mm | 0.25 | -60 to 330/350 | 5 m | | N9305617 |
| | 1.00 | -60 to 330/350 | 5 m | | N9305618 |

Elite-5 ms

| ID | df (mm) | Temp Limits (°C) | Integra-Guard | 30 m Part No. | 60 m Part No. |
|---------|---------|------------------|---------------|------------------|------------------|
| 0.25 mm | 0.10 | -60 to 330/350 | 5 m | | |
| | 0.25 | -60 to 330/350 | 5 m | | N9305619 |
| | 0.25 | -60 to 330/350 | 10 m | N9305620 | N9305621 |
| | 0.50 | -60 to 330/350 | 5 m | N9305622 | N9305623 |
| | 0.50 | -60 to 330/350 | 10 m | | N9305624 |
| 0.32 mm | 0.50 | -60 to 330/350 | 5 m | | N9305625 |
| | 1.00 | -60 to 330/350 | 5 m | | N9305626 |

Elite-624

| ID | df (mm) | Temp Limits (°C) | Integra-Guard | 30 m Part No. |
|---------|---------|------------------|---------------|------------------|
| 0.25 mm | 1.40 | -60 to 330/350 | 5 m | N9305627 |
| 0.32 mm | 1.80 | -60 to 330/350 | 5 m | N9305628 |
| 0.53 mm | 3.00 | -60 to 340/360 | 5 m | N9305629 |

Elite-1301

| ID | df (mm) | Temp Limits (°C) | Integra-Guard | 30 m Part No. |
|---------|---------|------------------|---------------|------------------|
| 0.53 mm | 3.00 | -60 to 330/350 | 5 m | N9305630 |

Elite-1701

| ID | df (mm) | Temp Limits (°C) | Integra-Guard | 30 m Part No. |
|---------|---------|------------------|---------------|------------------|
| 0.25 mm | 0.25 | -60 to 330/350 | 5 m | N9305631 |

Elite-WAX ETR

| ID | df (mm) | Temp Limits (°C) | Integra-Guard | 30 m Part No. |
|---------|---------|------------------|---------------|------------------|
| 0.25 mm | 0.25 | -60 to 330/350 | 5 m | N9305632 |
| 0.32 mm | 1.00 | -60 to 330/350 | 5 m | N9305633 |
| 0.53 mm | 1.00 | -60 to 340/360 | 5 m | N9305634 |

COLUMN CROSS REFERENCE CHART

Cross Reference Chart by Phase

| PerkinElmer | Phase Composition | USP | Agilent® | Alltech® |
|-------------------|--|-------------------------|--|------------------|
| Elite-1, Elite-M1 | dimethyl polysiloxane | G1, G2, G38 | HP-1, DB-1, CP-Sil 5 CB | 007-1AT-1, EC-1 |
| Elite-1HT | dimethyl polysiloxane | | DB-1ht | AT-1ht |
| Elite-1ms | dimethyl polysiloxane (low bleed) | | HP-1, HP-1ms, HP-1msUI, DB-1, DB-1MS, DB-1msUI, Ultra-1, VF-1ms, CP-Sil 5 CB | AT-1ms |
| Elite-5 | diphenyl dimethyl polysiloxane | G27, G36 | HP-5, DB-5, CP-Sil 8 CB | EC-5, AT-5 |
| Elite-5HT | diphenyl dimethyl polysiloxane | | DB-5ht, VF-5ht | |
| Elite-5ms | 1,4-bis(dimethylsiloxy)phenylene dimethyl polysiloxane | | DB-5ms, DB-5msUI, VF-5ms, 8 CG MS | |
| Elite-5ms II | diphenyl dimethyl polysiloxane | | HP-5, HP-5ms, DB-5, Ultra-2, CP-Sil 8 CB | |
| Elite-17 | (low bleed) | G3 | DB-17 | AT-50 |
| Elite-17ht | phenyl methyl polysiloxane | | DB-17ht | |
| Elite-17ms | phenyl methyl polysiloxane | | HP-50+, DB-17, DB-17ht, DB-608, CP Sil 24 CB | |
| Elite-17ms+ | diphenyl dimethyl polysiloxane | | DB-17ms, VF-17ms, CP-Sil 24 CB | |
| Elite-35 | Unique Phase | G42 | HP-35, DB-35 | AT-35, AT-35ms |
| Elite-35MS | diphenyl dimethyl polysiloxane | | DB-35ms, DB35msUI | |
| Elite-200 | Uunique Phase | G6 | DB-210, DB-200, VF-200ms | AT-210 |
| Elite-225 | trifluoropropylmethyl polysiloxane | G7, G19 | DB-225ms, CP Sil 43 CB | AT-225 |
| Elite-624 | cyanopropylmethyl phenylmethyl polysiloxane | G43 | DB-1301, DB-624, VF-1301ms, VF-624ms, CP-1301 | AT-624, AT-1301 |
| Elite-624 MS | Cyanopropylphenyl dimethyl polysiloxane | | DB-624, VF-624ms, CP-Select 624 CB | |
| Elite-1301 | Unique phase | G43 | DB-1301, DB-624, VF-1301ms, VF-624ms, CP-1301 | AT-624, AT-1301 |
| Elite-1701 | Cyanopropylphenyl dimethyl polysiloxane | G46 | DB-1701R, DB-1701, CP Sil 19 CB, VF-1701ms, VF-1701 Pesticides | AT-1701 |
| Elite-WAX | Cyanopropylphenyl dimethyl polysiloxane | G14, G15, G16, G20, G39 | DB-Wax, CP Wax 52 CB | AT-WAXms, EC-WAX |
| Elite-WAX ETR | Polyethylene glycol | G14, G15, G16, G20, G39 | HP-INNOWax, CP Wax 52 CB, VF-WAX MS | AT-WAX |

Cross Reference Chart by Application

| PerkinElmer | Applications | Agilent® | Alltech® | Machery-Nagel® |
|-----------------------|--|--|------------------------|---|
| Elite-502 | Volatile analytes by EPA Method 502.2 | DB-502.2 | | |
| Elite-608 | Semivolatile pesticides by EPA Method 608 | DB-608, HP-608 | | |
| Elite-VRX | Volatile analytes by EPA Methods 502.2, 601, 602, 8010, 8020 | DB-VRX | | |
| Elite-PONA | Detailed analysis of petroleum naphtha | HP-PONA, DB-Petro, CP Sil PONA CB | | |
| Elite-SimDist | Simulated Distillation & Hydrocarbons - ASTM 2887 | DB-2887 | AT-2887 | |
| Elite-FFAP | Free fatty acids | HP-FFAP, DB-FFAP, VF-DA, CP WAX58 CB, CP-FFAP CB | AT-AquaWax DA, AT-1000 | PERMABOND FFAP, OPTIMA FFAP, OPTIMA FFAP Plus |
| Elite-2560 | cis/transFAMES | HP-88 | | |
| Elite-2330 | cis/trans FAMES & Dioxins | VF-23ms | AT-Silar90 | |
| Elite-XLB | Polychlorinated biphenyl analytes by EPA Methods 8082, 6008, PCB congeners | DB-XLB, VF-XMS | | |
| Elite-VMS | Volatiles Organic Pollutants by GC-MS for EPA Methods 8260,624,524 | Unique Phase | | |
| Elite-BAC 1 Advantage | Blood Alcohol Testing | DB-ALC1 | | |
| Elite-BAC 2 Advantage | | DB-ALC2 | | |
| Elite-CLPesticides | Organochlorine pesticides by EPA Methods 505, 508, 608, 8081, 8082 | DB-CLP1 | | |
| Elite-CLPesticides2 | | DB-CLP2 | | |

COLUMN CROSS REFERENCE CHART

| Machery-Nagel® | Ohio Valley® | Phenomenex® | Quadrex® | Restek® | SGE® | Supelco® |
|---------------------------------|--------------|-------------------|-------------------|---------------|---------------|-----------------|
| OPTIMA 1 | OV-1 | ZB-1 | 007-1 | Rtx-1, Mtx-1 | BP1 | SPB-1 |
| | | ZB-1HTInferno | | Rxi-1HT | | |
| OPTIMA 1 MS, OPTIMA 1 MS Accent | | ZB-1, ZB-1ms | 007-1 | Rxi-1ms | BP-1 | SPB-1, Equity-1 |
| OPTIMA 5 | OV-5 | ZB-5 | 007-5 | Rtx-5 | BP5 | SPB-5 |
| OPTIMA 5HT | | ZB-5HTInferno | | Rxi-5HT | HT5 | |
| OPTIMA 5 MS Accent | OV-5MS | ZB-5msi | 007-5MS | Rxi-5Sil MS | BPX5 | SLB-5ms |
| OPTIMA 5, OPTIMA 5 MS | | ZB-5, ZB-5ms | | Rxi-5ms | BP5ms | |
| | OV-17 | | 007-17 | Rtx-50 | | SPB-50 |
| OPTIMA 17 | | ZB-50 | | Rxi-17 | | SPB-17 |
| OPTIMA 17 MS | | ZB-50 | | Rxi-17Sil MS | BPX50 | |
| | OV-35 | ZB-35 | 007-35 | Rtx-35 | BPX35, BPX608 | SPB-35, SPB-608 |
| OPTIMA 35 MS | | MR2 | | Rxi-35Sil MS | BPX35 | |
| OPTIMA 210 | | | | Rtx-200 | | |
| OPTIMA 225 | OV-225 | | 007-225 | Rtx-225 | BP225 | SPB-225 |
| OPTIMA 1301, OPTIMA 624 | OV-624 | ZB-624 | 007-1301, 007-624 | Rtx-624 | BP624 | SPB-624 |
| OPTIMA 624 LB | | ZB-624 | | Rxi-624Sil MS | BP624 | |
| OPTIMA 1301, OPTIMA 624 | OV-1301 | ZB-624 | 007-1301, 007-624 | Rtx-624 | BP624 | SPB-624 |
| OPTIMA 1701 | OV-1701 | ZB-1701, ZB-1701P | 007-1701 | Rtx-1701 | BP10 | Equity-1701 |
| OPTIMA WAX | Carbowax 20M | ZB-Wax | 007-CW | Rtx-Wax | BP20 | |
| OPTIMA WAX plus | | ZB-WaxPLUS | | Stabilwax | | Supelcowax-10 |

| Ohio Valley® | Phenomenex® | Quadrex® | Restek® | SGE® | Supelco® |
|--------------|-------------|----------|--------------------|---------|--------------------------------|
| | | | Rtx-502.2 | | VOCOL |
| | | 007-608 | | | SPB-608 |
| | | | Rtx-DHA | BP1PONA | Petrocol DH |
| | | | Rtx-2887 | | Petrocol 2887, Petrocol EX2887 |
| OV-351 | ZB-FFAP | | Stabilwax-DA | BP-21 | Nukol |
| | | | Rt-2560 | | SPB-2560 |
| | | 007-23 | | BPX70 | SP-2330, SP-2331, SP-2380 |
| | MR1, ZB-XLB | | Rxi-XLB | | |
| | ZB-BAC1 | | Rtx-BAC Plus 1 | | |
| | ZB-BAC2 | | Rtx-BAC Plus 2 | | |
| | | | Rtx-CLPesticides | | |
| | | | Rtx-CLPesticides 2 | Rtx-200 | |

Elite-1, Elite-1ms, Elite-1ht: 100% Dimethyl Polysiloxane

The Elite-1 100% dimethyl polysiloxane columns is a highly versatile, non-polar, crosslinked general purpose phase that is rugged, exhibiting long column lifetime, low bleed, and high maximum operating temperatures. The Elite-1ms is engineered for extremely low bleed for MS detectors. The Elite-1ht (High-Temp) is designed for reduced bleed when operating at higher temperature (up to 380 °C).

Primary Applications: Elite-1 columns are ideal for the analysis of non-polar petrochemical samples, such as detailed hydrocarbon analysis, hydrocarbon gases, petroleum oxygenates, petroleum aromatics, fuels, waxes, oils, sulfur compounds, mercaptans, and carbon disulfide. It also is an excellent phase for solvents, chemicals, flavors, fragrances, essential oils, air toxins, chlorofluorocarbons, arson analysis, pesticides, hydrocarbons and high-temperature applications.

Elite-1 Structure

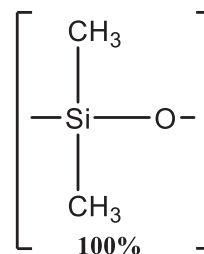

Features and Benefits

- Temperature Range: -60 °C to 350 °C/400 °C
- Equivalent to USP G1, G2, and G38 phases

Elite-1

| ID | df (mm) | Temp Limits (°C) | 5 m Part No. | 15 m Part No. | 30 m Part No. | 60 m Part No. | 105 m Part No. |
|---------|---------|------------------|-----------------|------------------|-----------------------------|------------------|-------------------|
| 0.25 mm | 0.10 | -60 to 330/350 | | N9316006 | N9316009 | N9316012 | |
| | 0.25 | -60 to 330/350 | | N9316007 | N9316010 | N9316013 | |
| | 0.50 | -60 to 330/350 | | N9316686 | N9316685 | | |
| | 1.00 | -60 to 320/340 | | N9316008 | N9316011 | N9316014 | |
| 0.32 mm | 0.10 | -60 to 330/350 | | N9316016 | N9316022 | N9316027 | |
| | 0.25 | -60 to 330/350 | N9316596 | N9316017 | N9316023 | N9316028 | |
| | 0.50 | -60 to 330/350 | | | N9316021¹ | N9316691 | |
| | 1.00 | -60 to 320/340 | | N9316018 | N9316024 | N9316029 | |
| | 1.50 | -60 to 310/330 | | | N9316050 | N9316580 | |
| | 3.00 | -60 to 280/300 | | N9316019 | N9316025 | N9316030 | |
| | 5.00 | -60 to 260/280 | | N9316020 | N9316026 | N9316031 | |
| 0.45 mm | 0.13 | -60 to 340/360 | | N9316032 | | | |
| | 0.42 | -60 to 310/330 | | N9316037 | N9316041 | | |
| | 1.27 | -60 to 310/330 | | N9316034 | N9316038 | N9316042 | |
| | 2.55 | -60 to 270/290 | | N9316035 | N9316039 | | N9316043 |
| | 4.25 | -60 to 260/280 | N9316032 | N9316036 | N9316040 | | |
| 0.53 mm | 0.15 | -60 to 320/340 | | N9316045 | | | |
| | 0.50 | -60 to 310/330 | | N9316049 | N9316053 | | |
| | 1.50 | -60 to 310/330 | | N9316046 | N9316050 | N9316054 | |
| | 3.00 | -60 to 270/290 | | N9316047 | N9316051 | N9315499 | N9316692 |
| | 5.00 | -60 to 270/290 | N9316044 | N9316048 | N9316052 | | |

| ID | df (mm) | Temp Limits (°C) | 10 m Part No. | 12 m Part No. | 20 m Part No. | 25 m Part No. | 50 m Part No. |
|---------|---------|------------------|------------------|------------------|------------------|------------------|-----------------------------|
| 0.05 mm | 0.05 | -60 to 330/350 | N9316056 | | | | |
| | 0.20 | -60 to 330/350 | N9316057 | | | | |
| 0.10 mm | 0.10 | -60 to 330/350 | N9316058 | | | | |
| | 0.40 | -60 to 320/340 | | | N9316061 | | |
| 0.18 mm | 0.18 | -60 to 330/350 | N9316001 | | N9316003 | | |
| | 0.40 | -60 to 320/340 | N9316002 | | N9316004 | | N9316005² |
| 0.20 mm | 0.33 | -60 to 330/350 | | N9316062 | | N9316063 | N9316064 |

¹ N9316021: Elite-1, 25M x 0.32mm x 0.52µm ² the length of N9316005 is 40m

NEW

Elite-1ms (Mass Spectrometry)

| ID | df (mm) | Temp Limits (°C) | 15 m | 20 m | 30 m | 60 m |
|---------|---------|------------------|-----------------|-----------------|-----------------|-----------------|
| | | | Part No. | Part No. | Part No. | Part No. |
| 0.18 mm | 0.18 | -60 to 330/350 | | N9305635 | | |
| | 2.00 | -60 to 330/350 | | N9305636 | | |
| 0.25 mm | 0.25 | -60 to 330/350 | N9305637 | | N9305638 | N9305639 |
| | 0.50 | -60 to 330/350 | N9305640 | | N9305641 | N9305642 |
| | 1.00 | -60 to 330/350 | N9305643 | | N9305644 | N9305645 |
| 0.32 mm | 0.25 | -60 to 330/350 | N9305646 | | N9305647 | N9305648 |
| | 0.50 | -60 to 330/350 | N9305649 | | N9305650 | N9305651 |
| | 1.00 | -60 to 330/350 | | | N9305652 | N9305653 |
| | 4.00 | -60 to 330/350 | | | N9305654 | |

Elite-1ht (High Temperature)

| ID | df (mm) | Temp Limits (°C) | 15 m | 30 m |
|---------|---------|------------------|-----------------|-----------------|
| | | | Part No. | Part No. |
| 0.25 mm | 0.10 | -60 to 400 | N9316268 | N9316269 |
| 0.32 mm | 0.10 | -60 to 400 | N9316270 | N9316271 |



Elite-5, Elite-5 Amine & Elite-5ht: 5% Diphenyl / 95% Dimethyl Polysiloxane

5% diphenyl/95% dimethyl polysiloxane stationary phase is a general purpose, low polarity phase that is the most popular GC stationary phase used for a wide variety of applications. These columns are commonly used for analysis of drugs, pesticides, hydrocarbons, PCBs, essential oils, semivolatiles and solvent impurities. The Elite-5 is a crosslinked phase in which all residual catalysts and low molecular weight fragments have been removed providing a tight mono-modal distribution and extremely low bleed. The Elite-5 is available in a standard version stable up to 350 °C, a high temperature version stable up to 400 °C and an Amine version engineered for analysis of amines and other basic compounds.

Features and Benefits

- Temperature Range: -60 °C to 350 °C
- Equivalent to USP G27 & G36 phases

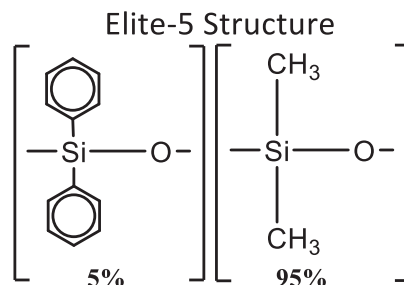

Elite-5

| | | | 5 m | 15 m | 30 m |
|---------|---------|------------------|-----------------|-----------------|-----------------|
| ID | df (mm) | Temp Limits (°C) | Part No. | Part No. | Part No. |
| 0.25 mm | 0.10 | -60 to 330/350 | N9316072 | N9316075 | N9316078 |
| | 0.25 | -60 to 330/350 | N9316073 | N9316076 | N9316079 |
| | 1.00 | -60 to 320/340 | N9316074 | N9316077 | N9316080 |
| 0.32 mm | 0.10 | -60 to 330/350 | N9316081 | N9316085 | N9316089 |
| | 0.25 | -60 to 330/350 | N9316082 | N9316086 | N9316090 |
| | 1.00 | -60 to 320/340 | N9316083 | N9316087 | N9316091 |
| 0.45 mm | 0.13 | -60 to 340/360 | | | N9316097 |
| | 0.42 | -60 to 310/330 | N9316093 | N9316096 | |
| | 1.27 | -60 to 310/330 | N9316092 | N9316094 | |
| | 4.25 | -60 to 260/280 | | N9316095 | |
| 0.53 mm | 0.50 | -60 to 310/330 | N9316099 | N9316102 | |
| | 1.50 | -60 to 310/330 | N9316098 | N9316100 | N9316103 |
| | 5.00 | -60 to 270/290 | | N9316101 | |

| | | | 10 m | 20 m | 40 m |
|---------|---------|------------------|------------------------------|------------------------------|------------------------------|
| ID | df (mm) | Temp Limits (°C) | Part No. | Part No. | Part No. |
| 0.05 mm | 0.05 | -60 to 325/350 | N9316104 | | |
| | 0.20 | -60 to 325/350 | N9316105 | | |
| 0.10 mm | 0.10 | -60 to 330/350 | | N9316108 | |
| | 0.40 | -60 to 320/340 | | N9316109 | |
| 0.18 mm | 0.18 | -60 to 330/350 | N9316066 | N9316068 | |
| | 0.4 | -60 to 320/340 | N9316067 | N9316069 | N9316071 |
| 0.20 mm | 0.33 | -60 to 330/350 | N9316110 ¹ | N9316111 ¹ | N9316112 ¹ |

¹ The lengths of N9316110, N9316111 and N9316112 are 12 m, 25 m and 50 m, respectively

Elite-5 Amine

| | | | 15 m | 30 m |
|---------|---------|------------------|-----------------|-----------------|
| ID | df (mm) | Temp Limits (°C) | Part No. | Part No. |
| 0.25 mm | 0.50 | -60 to 300/315 | N9316684 | N9316673 |
| | 1.00 | -60 to 300/315 | N9316674 | N9316675 |
| 0.32 mm | 1.00 | -60 to 300/315 | N9316676 | N9316677 |
| | 1.50 | -60 to 290/305 | N9316678 | N9316679 |
| 0.53 mm | 1.00 | -60 to 290/305 | | N9316680 |
| | 3.00 | -60 to 280/295 | N9316681 | N9316682 |

Elite-5ht (High Temperature)

| | | | 15 m | 30 m |
|---------|---------|------------------|-----------------|-----------------|
| ID | df (mm) | Temp Limits (°C) | Part No. | Part No. |
| 0.25 mm | 0.10 | -60 to 400 | N9316272 | N9316273 |
| 0.32 mm | 0.10 | -60 to 400 | N9316374 | N9316275 |

Elite-5ms: Extremely Low Bleed and Inertness

The Elite-5ms phase incorporates a phenyl group in the polymer backbone to improve thermal stability, reduce bleed and make the phase less prone to oxidation. This results in a phase that is inert to active compounds with extremely low bleed to meet the requirements of sensitive MS detectors. It is a general purpose column ideal for GC/MS analysis of semivolatiles, PAHs, chlorinated hydrocarbons, phthalates, phenols, amines, organochlorine & organophosphorus pesticides, drugs and solvent impurities.

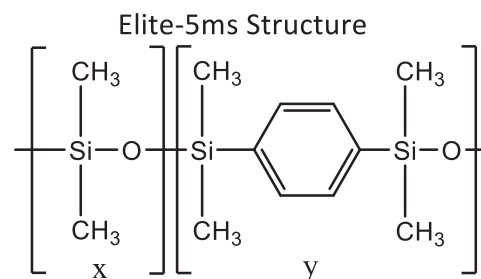

Features and Benefits

- Temperature Range: -60 °C to 350 °C
- Similar to USP G27 & G36 phases

Elite-5ms

| ID | df (mm) | Temp Limits (°C) | 15 m | 30 m | 60 m |
|---------|---------|------------------|-----------------------|-----------------------|-----------------------|
| | | | Part No. | Part No. | Part No. |
| 0.18 mm | 0.18 | -60 to 325/340 | | N9316276 ¹ | N9316277 ¹ |
| 0.20 mm | 0.33 | -60 to 330/350 | N9316301 ² | N9316302 ² | N9316303 ² |
| 0.25 mm | 0.25 | -60 to 330/350 | N9316279 | N9316282 | N9316286 |
| | 0.50 | -60 to 330/350 | | N9316284 | |
| | 1.00 | -60 to 325/350 | N9316280 | N9316283 | N9316287 |
| 0.32 mm | 0.25 | -60 to 330/350 | N9316289 | N9316293 | N9316297 |
| | 0.50 | -60 to 330/350 | | N9316295 | |
| | 0.52 | -60 to 330/350 | | N9316291 ³ | |
| | 1.00 | -60 to 325/350 | N9316290 | N9316294 | N9316298 |
| 0.53 mm | 1.50 | -60 to 310/330 | N9316299 | N9316300 | |

¹ The lengths of N9316276 and N9316277 are 20 m and 40 m, respectively

² The lengths of N9316301, N9316302 and N9316303 are 12 m, 25 m and 50 m, respectively

³ The length of N9316291 is 25 m.

Elite-5ms II: Tested for Low Bleed Performance

The Elite-5ms II columns incorporate the same phase as the Elite-5 columns but are specifically tested for low bleed performance.

Features and Benefits

- Temperature Range: -60 °C to 350 °C
- Equivalent to USP G27 & G36 phases

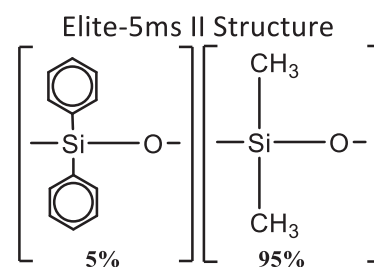

NEW

Elite-5ms II

| ID | df (mm) | Temp Limits (°C) | 15 m | 30 m | 60 m |
|---------|---------|------------------|----------|----------|----------|
| | | | Part No. | Part No. | Part No. |
| 0.25 mm | 0.10 | -60 to 330/350 | N9305655 | N9305656 | N9305657 |
| | 0.25 | -60 to 330/350 | N9305658 | N9305659 | N9305660 |
| | 0.50 | -60 to 330/350 | N9305661 | N9305662 | N9305663 |
| | 1.00 | -60 to 325/350 | N9305664 | N9305665 | |
| 0.32 mm | 0.10 | -60 to 330/350 | N9305666 | N9305667 | N9305668 |
| | 0.25 | -60 to 330/351 | N9305669 | N9305670 | N9305671 |
| | 0.50 | -60 to 330/350 | | N9305672 | N9305673 |
| | 1.00 | -60 to 325/350 | N9305674 | N9305675 | N9305698 |

Elite-17: (50%-phenyl)-methylpolysiloxane

The Elite-17 columns are general purpose, mid-polarity, (50%-phenyl)-methylpolysiloxane phases for the analysis of pesticides, herbicides, phthalate esters, sterols, and rosin acids. All Elite 17 phases incorporate a crosslinking technology for very low bleed and long column lifetimes.

Features and Benefits

- Temperature Range: 40 °C to 320 °C
- Equivalent to USP G3 phase

Elite-17 Structure

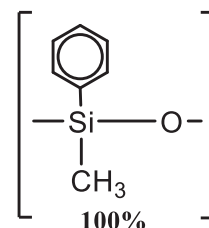

Elite-17

| ID | df (mm) | Temp Limits (°C) | 5 m | 15 m | 30 m | 60 m |
|---------|---------|------------------|-----------------|-----------------|-----------------|-----------------|
| | | | Part No. | Part No. | Part No. | Part No. |
| 0.25 mm | 0.15 | 40 to 300/320 | | N9316117 | N9316120 | |
| | 0.25 | 40 to 300/320 | | N9316118 | N9316121 | N9316123 |
| | 0.50 | 40 to 290/310 | | N9316119 | N9316122 | |
| 0.32 mm | 0.15 | 40 to 300/320 | | N9316124 | N9316127 | |
| | 0.25 | 40 to 300/320 | | N9316125 | N9316128 | |
| | 0.50 | 40 to 290/310 | | N9316126 | N9316129 | |
| 0.45 mm | 0.85 | 40 to 270/290 | | N9316131 | N9316132 | N9316133 |
| | 1.70 | 40 to 260/280 | N9316130 | | | |
| 0.53 mm | 1.00 | 40 to 260/280 | | N9316135 | N9316136 | N9316137 |
| | 2.00 | 40 to 250/270 | N9316134 | | | |

| ID | df (mm) | Temp Limits (°C) | 10 m | 20 m |
|---------|---------|------------------|-----------------|-----------------|
| | | | Part No. | Part No. |
| 0.05 mm | 0.05 | 40 to 280/300 | N9316138 | |
| | 0.10 | 40 to 280/300 | N9316139 | |
| 0.10 mm | 0.02 | 40 to 280/300 | N9316141 | |
| | 0.10 | 40 to 280/300 | N9316140 | N9316142 |
| | 0.20 | 40 to 280/300 | | N9316143 |
| 0.18 mm | 0.18 | 40 to 310/330 | N9316113 | N9316115 |
| | 0.3 | 40 to 300/320 | N9316114 | N9316116 |

Elite-17ht (High Temperature)

| ID | df (mm) | Temp Limits (°C) | 15 m | 30 m | 60 m |
|---------|---------|------------------|-----------------|-----------------|-----------------|
| | | | Part No. | Part No. | Part No. |
| 0.25 mm | 0.15 | 40 to 300/320 | N9316263 | N9316264 | |
| 0.32 mm | 0.15 | 40 to 300/320 | N9316265 | N9316266 | N9316267 |

Elite-17ms: Mid-polarity, Very Low Bleed

The Elite-17ms columns are general purpose, mid-polarity columns that are coated with a crosslinked, (50%-diphenyl)-dimethylpolysiloxane engineered for very low bleed to meet the requirements of sensitive MS detectors.

Features and Benefits

- Temperature Range: 40 °C to 320 °C
- Equivalent to USP G3 phase

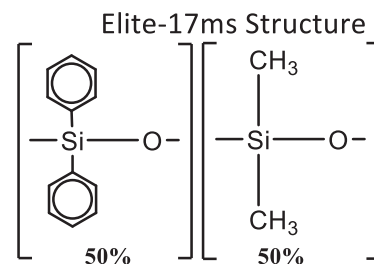

Elite-17ms

| ID | df (mm) | Temp Limits (°C) | 15 m Part No. | 30 m Part No. | 60 m Part No. |
|---------|---------|------------------|------------------|------------------|------------------|
| 0.18 mm | 0.18 | 40 to 320/340 | N9316534 | | |
| 0.25 mm | 0.15 | 40 to 300/320 | N9316535 | N9316537 | |
| | 0.25 | 40 to 300/320 | N9316536 | N9316538 | N9316539 |
| 0.32 mm | 0.15 | 40 to 300/320 | N9316540 | N9316542 | |
| | 0.25 | 40 to 300/320 | N9316541 | | |

Elite-17ms+: High Temperature, Extremely Low Bleed

The new Elite-17ms+ columns are general purpose, mid-polarity columns that are coated with a unique blend of linked dimethyl polysiloxanes and diphenyl polysiloxanes that is inert and selective for active environmental compounds, such as PAHs, while maintaining a similar selectivity and polarity as traditional Elite-17 phases. This phase has been engineered for extremely low bleed as required by MS detectors at higher temperature (up to 360 °C) as required for sensitive MS detectors.

Features and Benefits

- Temperature Range: 40 °C to 360 °C
- Equivalent to USP G3 phase

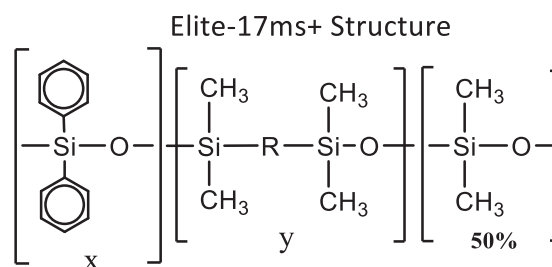

NEW

Elite-17ms+

| ID | df (mm) | Temp Limits (°C) | 10 m Part No. | 15 m Part No. | 20 m Part No. | 30 m Part No. | 60 m Part No. |
|---------|---------|------------------|------------------|------------------|------------------|------------------|------------------|
| 0.15 mm | 0.15 mm | 40 to 340/360 | N9305677 | | N9305678 | | |
| 0.18 mm | 0.18 mm | 40 to 340/360 | | | N9305679 | | |
| | 0.36 mm | 40 to 340/360 | | | N9305680 | | |
| 0.25 mm | 0.25 mm | 40 to 340/360 | | N9305681 | | N9305682 | N9305685 |
| 0.32 mm | 0.25 mm | 40 to 340/360 | | N9305683 | | N9305684 | |

Elite-35: (35%-diphenyl)-dimethylpolysiloxane

The Elite-35 columns are general purpose, mid-polarity columns that are coated with a crosslinked, (35%-diphenyl)-dimethylpolysiloxane commonly used for organochlorine pesticides, PDB congeners (e.g. Alaclor mixes), herbicides, pharmaceuticals, sterols, phthalate esters and rosin acids. The Elite-35 column is a popular confirmation column for pesticides and herbicides, in conjunction with an Elite-5 or Elite-1701. The higher phenyl content results in useful elution order and retention time changes.

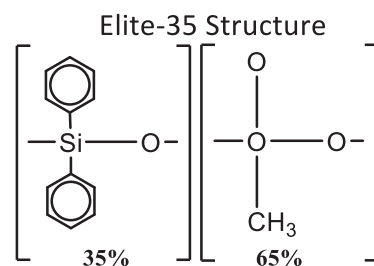

Features and Benefits

- Temperature Range: 40 °C to 320 °C
- Equivalent to USP G42 phase

Elite-35

| ID | df (mm) | Temp Limits (°C) | 15 m | 30 m |
|---------|---------|------------------|-----------------|-----------------|
| | | | Part No. | Part No. |
| 0.25 mm | 0.15 | 40 to 300/320 | | N9316144 |
| | 0.25 | 40 to 300/320 | | N9316145 |
| 0.32 mm | 0.25 | 40 to 300/320 | | N9316146 |
| | 0.50 | 40 to 290/310 | | N9316147 |
| 0.45 mm | 0.42 | 40 to 290/310 | | N9316150 |
| | 0.85 | 40 to 280/300 | N9316148 | N9316149 |
| 0.53 mm | 0.50 | 40 to 260/280 | | N9316153 |
| | 1.00 | 40 to 260/280 | N9316151 | N9316152 |

Elite-35ms: High Temperature, Extremely Low Bleed

The Elite-35ms columns are general purpose, mid-polarity columns that are coated with a unique blend of linked dimethyl polysiloxanes and diphenyl polysiloxanes that are inert and selective for substituted polar compounds, such as drugs, pesticides, herbicides, PCBs and phenyls, while maintaining a similar selectivity and polarity as traditional Elite-35 phases. This phase has been engineered for extremely low bleed as required by MS detectors at higher temperature (up to 360 °C) as required for sensitive MS detectors.

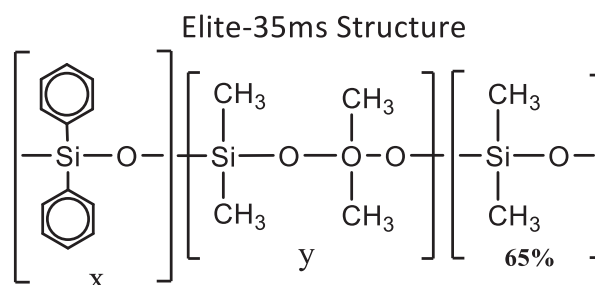

Features and Benefits

- Temperature Range: 50 °C to 340 °C/360 °C
- Equivalent to USP G42 phase

Elite-35ms

NEW

| ID | df (mm) | Temp Limits (°C) | 15 m | 30 m |
|---------|---------|------------------|-----------------|-----------------|
| | | | Part No. | Part No. |
| 0.25 mm | 0.25 mm | 50 to 340/360 | N9305686 | N9305687 |
| | 0.50 mm | 50 to 340/360 | N9305688 | N9305689 |
| | 1.00 mm | 50 to 320/340 | N9305690 | N9305691 |
| 0.32 mm | 0.25 mm | 40 to 340/360 | N9305692 | N9305693 |
| | 0.50 mm | 40 to 340/360 | N9305694 | N9305695 |
| | 1.00 mm | 40 to 320/340 | N9305696 | N9305697 |

Elite-200: (Trifluoropropyl)-methylpolysiloxane

Elite-200 columns contain a (trifluoropropyl)-methylpolysiloxane stationary phase that has a unique selectivity which changes elution orders and resolves compounds that phenyl, cyano, or Carbowax® phases cannot. These columns have accomplished many difficult separations not possible on any other bonded stationary phase. Many analysts consider these the best, most inert mid-polarity columns available. The Elite-200 column offers exceptional thermal stability, low bleed, and superior inertness—even for active compounds such as phenols, and with sensitive detectors such as ECDs, NPDs, and MSDs. It is a good general purpose column for solvents, Freon® fluorocarbons, alcohols, ketones, silanes, glycols, and drugs of abuse. An excellent column for confirmation of phenols, nitrosamines, organochlorine pesticides, chlorinated hydrocarbons, and chlorophenoxy herbicides when paired with an Elite-5 column.

Elite-200 Structure

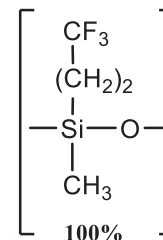

Features and Benefits

- Temperature Range: 40 °C to 320 °C
- Equivalent to USP G6 phase

Elite-200

| ID | df (mm) | Temp Limits (°C) | 15 m | 30 m | 60 m |
|---------|---------|------------------|-----------------|-----------------|-----------------|
| | | | Part No. | Part No. | Part No. |
| 0.25 mm | 0.10 | -20 to 320/340 | N9316616 | N9316617 | |
| | 0.25 | -20 to 320/340 | N9316618 | N9316619 | |
| | 0.50 | -20 to 310/330 | N9316620 | N9316621 | |
| | 1.00 | -20 to 290/310 | N9316622 | N9316623 | N9316624 |
| 0.32 mm | 0.25 | -20 to 320/340 | N9316625 | N9316626 | |
| | 0.50 | -20 to 310/330 | N9316627 | N9316628 | |
| | 1.00 | -20 to 290/310 | N9316629 | N9316630 | N9316631 |
| | 1.50 | -20 to 280/300 | N9316632 | N9316633 | N9316634 |
| 0.53 mm | 0.25 | -20 to 310/330 | N9316635 | N9316636 | N9316637 |
| | 0.50 | -20 to 300/320 | N9316638 | N9316639 | N9316640 |
| | 1.00 | -20 to 290/310 | N9316641 | N9316642 | N9316643 |
| | 1.50 | -20 to 280/300 | N9316644 | N9316645 | N9316646 |
| | 3.00 | -20 to 260/280 | N9316647 | N9316648 | N9316649 |

Elite-225: (50%-cyanopropylmethyl)-phenylmethylpolysiloxane

The Elite-225 is a general purpose column for the analysis of FAMES, carbohydrates, sterols and flavor compounds. The cyanopropyl-containing Elite-225 phase is slightly less polar than bonded polyethylene glycol (PEG) phases, but it can be used for many of the same applications. Improvements to the Elite-225 polymer have increased thermal stability, reduced bleed, and improved inertness. The Elite-225 column provides a 20 °C thermal stability advantage over other "225" columns because of our unique polymer synthesis technology and proprietary siloxane deactivation. In most similar columns, the Carbowax® deactivation layer is not fully compatible with the cyanopropyl siloxane polymer, which can cause adsorption, tailing of active compounds, and lower efficiency.

Features and Benefits

- Temperature Range: 40 °C to 240 °C
- Equivalent to USP G7, G19 phases

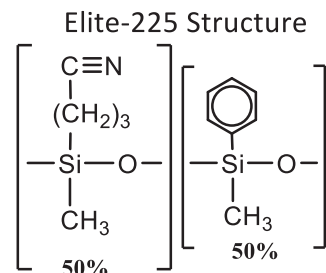

Elite-225

| ID | df (mm) | Temp Limits (°C) | 10 m Part No. | 15 m Part No. | 20 m Part No. | 30 m Part No. | 60 m Part No. |
|---------|---------|------------------|------------------|------------------|------------------|------------------|------------------|
| 0.05 mm | 0.05 | 45 to 220/240 | N9316186 | | | | |
| 0.10 mm | 0.10 | 45 to 220/240 | | | N9316187 | | |
| 0.18 mm | 0.2 | 45 to 220/240 | N9316172 | | N9316173 | | |
| 0.25 mm | 0.15 | 45 to 220/240 | | N9316174 | | N9316176 | N9305631 |
| | 0.25 | 45 to 220/240 | | N9316175 | | N9316177 | |
| 0.32 mm | 0.15 | 45 to 220/240 | | N9316178 | | N9316180 | |
| | 0.25 | 45 to 220/240 | | N9316179 | | N936181 | |
| 0.45 mm | 0.85 | 40 to 200/220 | | N9316182 | | N9316183 | |
| 0.53 mm | 1.00 | 40 to 200/220 | | N9316184 | | N9316185 | |

Elite-1301: (6%-cyanopropylphenyl)-methylpolysiloxane

The Elite-1301 column is a general purpose low to mid-polarity phase commonly used for the analysis of residual solvents, alcohols, oxygenates and volatile organic compounds. Many analysts feel the Elite-1301 column is the best cyanosiloxane bonded stationary phase available, with no other column supplier providing lower bleed, longer lifetime, or better inertness. Our polymer is fully characterized to ensure long-term reproducibility, column-to-column consistency, and low bleed—even with sensitive detectors such as ECD and MS.

Features and Benefits

- Temperature range: -20 °C to 280 °C
- Equivalent to USP G43 phase

Elite-1301

| ID | df (mm) | Temp Limits (°C) | 15 m Part No. | 30 m Part No. | 60 m Part No. |
|---------|---------|------------------|------------------|------------------|------------------|
| 0.18 mm | 0.40 | -20 to 280 | N9316211 | | |
| 0.25 mm | 0.25 | -20 to 280 | N9316212 | N9316214 | N9316216 |
| | 1.00 | -20 to 260/280 | N9316213 | N9316215 | N9316217 |
| 0.32 mm | 0.25 | -20 to 280 | N9316218 | N9316220 | N9316222 |
| | 1.00 | -20 to 260/280 | N9316219 | N9316221 | N9316223 |
| 0.45 mm | 0.85 | -20 to 260/280 | N9316224 | N9316225 | |
| 0.53 mm | 1.00 | -20 to 260/280 | N9316226 | N9316227 | |

Elite-1301 Structure

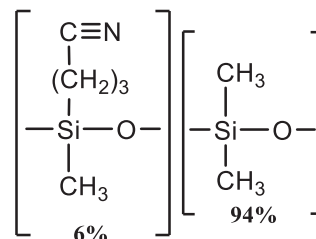

Elite-1701: (14%-cyanopropylphenyl)-methylpolysiloxane

The Elite-1701 is a good mid-polarity general purpose column for the analysis of alcohols, oxygenates, PCB congeners (e.g. Aroclor mixes), and pesticides. It is one of the more popular stationary phases used in capillary GC. The mix of cyano and phenyl functional groups increases the polarity and offers a different elution order relative to less polar Elite-1 or Elite-5 columns. An Elite-1701 column is ideal for confirmation analysis in combination with an Elite-35 or Elite-5 column. The polymer is fully characterized to ensure long-term reproducibility, column-to-column consistency, and low bleed – even with sensitive detectors such as ECD and MS.

Features and Benefits

- Temperature Range: -20 °C to 280 °C
- Equivalent to USP G46 phase

Elite-1701 Structure

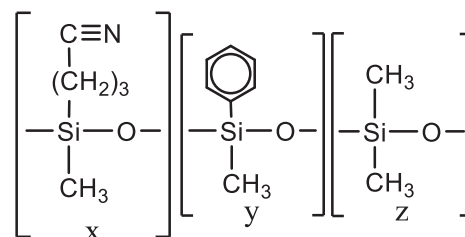

Elite-1701

| ID | df (mm) | Temp Limits (°C) | 15 m | | 30m | 50 m | 60 m |
|---------|---------|------------------|-----------------|-----------------|-----------------|----------|-----------------|
| | | | Part No. | Part No. | Part No. | Part No. | |
| 0.25 mm | 0.15 | -20 to 280 | N9316230 | | | | N9316236 |
| | 0.25 | -20 to 280 | N9316231 | N9316234 | | | N9316237 |
| | 1.00 | -20 to 260/280 | N9316232 | N9316235 | | | N9316238 |
| 0.32 mm | 0.15 | -20 to 280 | N9316239 | N9316242 | | | N9316246 |
| | 0.25 | -20 to 280 | N9316240 | N9316243 | | | N9316247 |
| | 1.00 | -20 to 260/280 | N9326141 | N9316244 | N9316245 | | N9316248 |
| 0.45 mm | 0.42 | -20 to 260/270 | N9316250 | N9316252 | | | |
| | 0.85 | -20 to 250/270 | N9316249 | N9316251 | | | |
| 0.53 mm | 0.50 | -20 to 260/270 | N9316254 | N9316256 | | | |
| | 1.00 | -20 to 250/270 | N9316253 | N9316255 | | | |

| ID | df (mm) | Temp Limits (°C) | 10 m | 20 m |
|---------|---------|------------------|-----------------|-----------------|
| | | | Part No. | Part No. |
| 0.05 mm | 0.05 | -20 to 280 | N9316257 | |
| | 0.20 | -20 to 280 | N9316258 | |
| 0.10 mm | 0.10 | -20 to 280 | | N9316259 |
| | 0.40 | -20 to 270/280 | | N9316250 |
| 0.18 mm | 0.4 | -20 to 270/280 | N9316228 | N9316229 |

Elite-WAX: Polar Polyethylene glycol (PEG)

The Elite-WAX column is a general purpose polar PEG phase commonly used for the analysis of polar compounds like alkenols, glycols and aldehydes. The extended operating temperature range up to 250 °C allowing analysis of compounds that have a wide volatility range. Selectivity of the Elite-WAX is comparable to other Carbowax® columns for compounds of intermediate to high polarity.

Features and Benefits

- Temperature range: 20 °C to 250 °C
- Equivalent to USP G14, G15, G16, G20 and G39 phases

Elite-WAX Structure

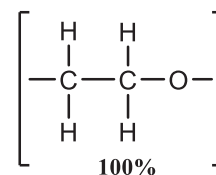

Elite-WAX

| ID | df (mm) | Temp Limits (°C) | 15 m | 30m | 60 m |
|---------|---------|------------------|-----------------|-----------------|-----------------|
| | | | Part No. | Part No. | Part No. |
| 0.25 mm | 0.15 | 20 to 250 | N9316399 | N9316402 | N9316405 |
| | 0.25 | 20 to 250 | N9316400 | N9316403 | N9316406 |
| | 0.50 | 20 to 250 | N9316401 | N9316404 | N9316407 |
| 0.32 mm | 0.15 | 20 to 250 | N9316408 | N9316411 | |
| | 0.25 | 20 to 250 | N9316409 | N9316412 | N9316416 |
| | 0.50 | 20 to 250 | N9316410 | N9316413 | N9316417 |
| 0.45 mm | 0.42 | 20 to 250 | N9316420 | N9316422 | |
| | 0.85 | 20 to 240/250 | N9316419 | N9316421 | N9316423 |
| | 1.70 | 50 to 230 | N9316418 | | |
| 0.53 mm | 0.50 | 20 to 250 | N9316426 | N9316428 | |
| | 1.00 | 20 to 240/250 | N9316425 | N9316427 | N9316429 |

Elite-MWAX: Metal Column

| ID | df (mm) | Temp Limits (°C) | 30 m |
|---------|---------|------------------|-----------------|
| | | | Part No. |
| 0.53 mm | 1.00 | 20 to 240/250 | N9316478 |

Elite-WAX ETR: Extended Temperature Range WAX

The Elite-WAX ETR columns are manufactured with a special bonding process that binds the Carbowax® polymer to the polar deactivated silica. This results in a low bleed WAX column that exhibits extended lifetimes even when repeatedly heated to 260 °C. The bonding mechanism of this column produces very stable polar retention that does not shift as often as observed with other WAX-type columns. Additionally, the bonding mechanism makes this column rugged enough to stand up to repeated water injections and allows solvent washing to rejuvenate the column. The Elite-WAX ETR can be used for a wide range of compounds and matrices such as: FAMES, flavor compounds, essential oils, solvents, aromatics, acrolein/acrylonitrile (EPA 603), oxygenated compounds, impurities in water matrices and alcoholic beverages.

Features and Benefits

- Temperature Range: 40 °C to 260 °C
- Equivalent to to USP G14, G15, G16, G20 and G39 phases

Elite-WAX ETR

| ID | df (mm) | Temp Limits (°C) | 5 m | 15 m | 30m | 50 m | 60 m |
|---------|---------|------------------|-----------------|-----------------|-----------------|-----------------|-----------------|
| | | | Part No. | Part No. | Part No. | Part No. | Part No. |
| 0.25 mm | 0.25 | 40 to 250 | | N9316547 | N9316549 | | N9316551 |
| | 0.50 | 40 to 250 | | N9316548 | N9316550 | | |
| 0.32 mm | 0.25 | 40 to 250 | | N9316552 | N9316555 | | N9316559 |
| | 0.50 | 40 to 250 | | N9316553 | N9316556 | | N9316560 |
| | 1.00 | 40 to 240/250 | | N9316554 | N9316557 | N9316558 | N9316561 |
| 0.45 mm | 0.85 | 40 to 240 | | N9316563 | N9316564 | | N9316565 |
| | 1.70 | 40 to 230/250 | N931656 | | | | |
| 0.53 mm | 1.00 | 40 to 240/250 | | N9316567 | N9316569 | | N9316571 |
| | 2.00 | 40 to 220/230 | N9316566 | N9316568 | N9316570 | | |

Elite-624: EPA Volatile Organic Pollutants

The Elite-624 column is a specially engineered, low to mid-polarity (6%-cyanopropylphenyl)-dimethylpolysiloxane phase. The unique polarity of the Elite-624 column makes it ideal for analyzing volatile organic pollutants and it is recommended in U.S. EPA methods. Although the Elite-502.2 column is recommended in many methods, the Elite-624 column offers better resolution of early eluting compounds. The Elite-624 phase produces greater than 90% resolution of the first six gases in EPA Methods 8260 and 524.2. This stationary phase is especially well-suited for EPA Method 524.2 since it resolves 2-nitropropane from 1,1-dichloropropanone, which share quantification ion m/z 43 and must be separated chromatographically.

Features and Benefits

- Temperature range: -20 °C to 240 °C
- Equivalent to USP G43 phase

Elite-624 Structure

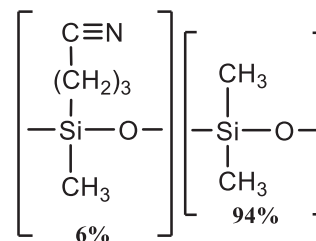

Elite-624

| ID | df (mm) | Temp Limits (°C) | 20 m Part No. | 25 m Part No. | 30 m Part No. | 60 m Part No. | 75 m Part No. |
|---------|---------|------------------|------------------|------------------|------------------|------------------|------------------|
| 0.18 mm | 1.00 | -20 to 240 | N9316200 | | | | |
| 0.20 mm | 1.12 | -20 to 240 | | N9316209 | | | |
| 0.25 mm | 1.40 | -20 to 240 | | | N9316201 | N9316202 | |
| 0.32 mm | 1.80 | -20 to 240 | | | N9316203 | N9316204 | |
| 0.45 mm | 2.55 | -20 to 240 | | | N9316205 | | N9316206 |
| 0.53 mm | 3.00 | -20 to 240 | | | N9316207 | | N9316208 |

Elite-624ms: Low Bleed, High Thermal Stability

The Elite-624ms incorporates a unique proprietary blend of cyanopropyl and methyl siloxanes that results in a very inert, extremely low bleed and high thermal stability column. This column provides excellent peak shape for a wide range of compounds and is highly selective for residual solvents making it a great choice for USP<467>. These columns are manufactured for column-to-column reproducibility, so they are well suited for validated methods.

Features and Benefits

- Temperature Range: -20 °C to 320 °C
- Similar to USP 43 phase

Elite-624ms Structure

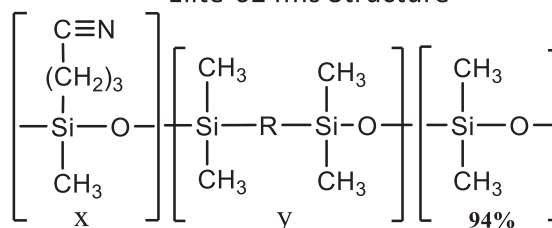

Elite-624ms

NEW

| ID | df (mm) | Temp Limits (°C) | 20 m Part No. | 30 m Part No. | 60 m Part No. |
|---------|---------|------------------|------------------|------------------|------------------|
| 0.18 mm | 1.00 | -20 to 240 | N9315067 | | |
| 0.25 mm | 1.40 | -20 to 240 | | N9315068 | |
| 0.32 mm | 1.80 | -20 to 240 | | N9315069 | N9315070 |

Elite-BAC Advantage: Blood Alcohol Content

The Elite-BAC Advantage columns are optimized for selectivities guaranteed to resolve ethanol, internal standards, and frequently encountered interferences. These application-specific columns for blood alcohol analysis baseline separate all critical compounds, including ethanol, methanol, acetone, tert-butanol, acetaldehyde, isopropanol, and n-propanol, in less than 2 minutes. Every Elite-BAC 1 Advantage and Elite-BAC 2 Advantage column is qualified with a test mix containing these important BAC target compounds to ensure reproducibility. These columns, baseline separate all blood alcohol compounds in blood, breath, or urine, in less than 2 minutes, under isothermal conditions. Isothermal analysis increases productivity by eliminating the need for oven cycling. Confirmation is easily achieved with this tandem set because there are two elution order changes between the columns.

Features and Benefits

- Robust and reproducible column chemistry ensures longer column lifetime and consistent results
- Stable to 260 °C

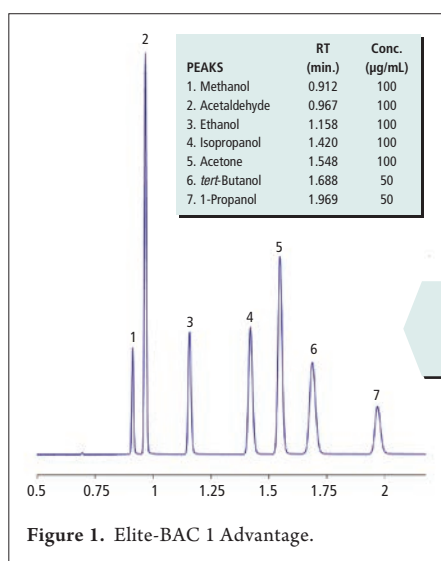

- Clear baseline resolution
- Symmetrical peaks
- Run time under 2 min

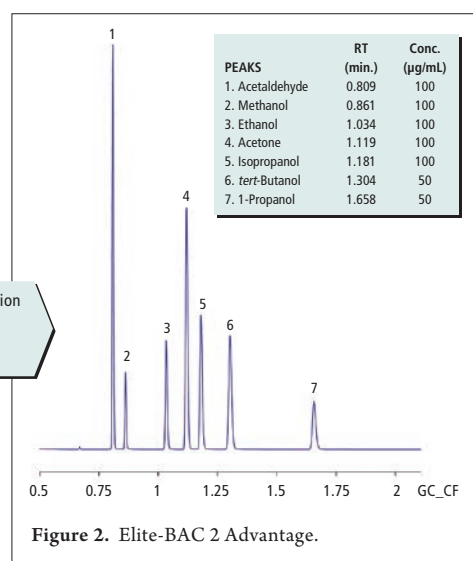

Elite-BAC Advantage

NEW

| Column Type | ID | df (mm) | Temp Limits (°C) | 10 m | 30 m |
|-----------------------|---------|---------|------------------|-----------------|-----------------|
| | | | | Part No. | Part No. |
| Elite-BAC 1 Advantage | 0.18 mm | 1.00 | -20 to 240/260 | N9315075 | |
| | 0.32 mm | 1.80 | -20 to 240/260 | | N9315071 |
| | 0.53 mm | 3.00 | -20 to 240/260 | | N9315072 |
| Elite-BAC 2 Advantage | 0.18 mm | 0.34 | -20 to 240/260 | N9315076 | |
| | 0.32 mm | 0.60 | -20 to 240/260 | | N9315073 |
| | 0.53 mm | 1.00 | -20 to 240/260 | | N9315074 |
| Elite-BAC 3 Advantage | 0.18 mm | 0.30 | 20 to 250 | N9316575 | |

Elite-VMS: Volatile Organic Pollutants by GC/MS

Elite-VMS columns offer lower bleed, better selectivity, and overall faster analysis for separating volatile organic compounds. These columns are capable of separating the compounds listed in U.S. EPA Method 8260B in under 10 minutes. The Elite-VMS stationary phase is a highly stable polymer that provides outstanding analysis of volatile compounds on MS detectors. The 0.18 and 0.25 mm ID columns allow sample splitting at the injection port, eliminating the added expense and maintenance of a jet separator. A 0.45 mm or 0.53 mm ID column can be directly connected to the purge-and-trap transfer line in a system equipped with a jet separator.

Features and Benefits

- Temperature Range: -40 °C to 240/260 °C
- No known equivalent phases

Elite-VMS

| ID | df (mm) | Temp Limits (°C) | 30 m | 60 m | 75 m |
|---------|---------|------------------|-----------------------------|-----------------------------|-----------------|
| | | | Part No. | Part No. | Part No. |
| 0.18 mm | 1.00 | -40 to 240/260 | N9316650¹ | N9316651¹ | |
| 0.25 mm | 1.40 | -40 to 240/260 | N9316652 | N9316653 | |
| 0.32 mm | 1.80 | -40 to 240/260 | N9316654 | N9316655 | |
| 0.45 mm | 2.55 | -40 to 240/260 | N9316656 | N9316657 | |
| 0.53 mm | 3.00 | -40 to 240/260 | N9316658 | N9316659 | N9316660 |

¹ The lengths of N9316650 and N9316651 are 20 m and 40 m, respectively.

Elite-XLB: Exceptionally Low Bleed for GC/MS

The Elite-XLB phase is a proprietary low-polarity, very inert and exceptionally low bleed column for GC/MS analysis of pesticides, PCB congeners (e.g., Aroclor mixes) and PAHs. Improvements in polymer synthesis and tubing deactivation enable us to make inert, stable Elite-XLB columns especially well-suited for analyzing active, high molecular weight compounds with sensitive GC-MS systems, including ion trap detectors. Excellent efficiency, coupled with inertness, low bleed, and high thermal stability, make Elite-XLB columns ideal for analyzing semivolatile compounds in drinking water (e.g., US EPA Method 525).

Features and Benefits

- Temperature Range: 30 °C to 340/360 °C
- No known equivalent phases

Elite-XLB

| ID | df (mm) | Temp Limits (°C) | 15 m | 30 m | 60 m |
|---------|---------|------------------|-----------------------------|-----------------------------|-----------------|
| | | | Part No. | Part No. | Part No. |
| 0.18 mm | 0.18 | 40 to 340/360 | | N9316480¹ | |
| 0.20 mm | 0.33 | 40 to 340/360 | N9316496² | N9316497² | |
| 0.25 mm | 0.10 | 40 to 340/360 | | N9316483 | |
| | 0.25 | 40 to 340/360 | N9316481 | N9316484 | N9316487 |
| | 1.00 | 40 to 340/360 | N9318482 | N9316485 | |
| 0.32 mm | 0.10 | 40 to 340/360 | | N9316489 | |
| | 0.25 | 40 to 340/360 | N9316488 | N9316490 | N9316493 |
| | 0.50 | 40 to 340/360 | | N9316492 | |
| | 1.00 | 40 to 340/360 | | N9316491 | |
| 0.53 mm | 1.50 | 40 to 320/340 | N9316494 | N9316495 | |

¹ The length of N9316480 is 20 m.

² The lengths of N9316496 and N9316497 are 12 m and 25 m, respectively.

Elite-Volatiles: Volatile Organic Compounds

The Elite-Volatiles stationary phase and optimized column dimensions provide low bleed, excellent resolution, and fast analysis times for volatile organic pollutants. These columns are excellent for U.S. EPA method 8021 compounds.

Features and Benefits

- Temperature Range: -20 °C to 240 °C
- Proprietary phase

Elite-Volatiles

| ID | df (mm) | Temp Limits (°C) | 30 m | 60 m | 75 m |
|---------|---------|------------------|-----------------|-----------------|-----------------|
| | | | Part No. | Part No. | Part No. |
| 0.25 mm | 1.40 | -20 to 240 | N9316388 | N9316389 | |
| 0.32 mm | 0.10 | -20 to 240 | N9316390 | N9316391 | |
| 0.45 mm | 2.55 | -20 to 240 | N9316392 | | N9316393 |

Elite-CLPesticides: Chlorinated Pesticides

Elite-CLPesticides is specially designed to overcome the coelutions and analyte breakdown typically encountered in chlorinated pesticide analyses for U.S. EPA methods 8081, 608, and CLP. Column bleed measured by ECD is extremely low at temperatures greater than 300 °C, which is critical for baking out the column to remove high-boiling compounds commonly found in pesticide/PCB extracts.

Primary Applications: Chlorinated Pesticides and Herbicides. U.S. EPA Methods 504, 608, 619, 8081, 8151, and CLP.

Features and Benefits

- Thermally stable to 340 °C
- Low column bleed – ideal for ECD or GC/MS analysis
- Exceeds performance criteria for U.S. EPA Methods 8081, 608 and CLP
- Baseline separation in less than 15 minutes

Elite-CLPesticides for Chlorinated Pesticides

| Column Type | ID | df (mm) | Temp Limits (°C) | 10 m | 30 m |
|----------------------|---------|---------|------------------|-----------------|-----------------|
| | | | | Part No. | Part No. |
| Elite-CLPesticides | 0.25 mm | 0.25 | -60 to 320/340 | N9316661 | N9316662 |
| | 0.32 mm | 0.50 | -60 to 320/340 | N9316663 | N9316664 |
| | 0.53 mm | 0.50 | -60 to 300/320 | N9316665 | N9316666 |
| Elite-CLPesticides 2 | 0.25 mm | 0.20 | -20 to 240/260 | N9316667 | N9316668 |
| | 0.32 mm | 0.25 | -20 to 240/260 | N9316669 | N9316670 |
| | 0.53 mm | 0.42 | -20 to 240/260 | N9316671 | N9316672 |

Elite-502.2: U.S. EPA Method 502.2

Application: Analysis of volatiles by U.S. EPA method 502.2

Phase: Proprietary Dimethyl-diphenyl polysiloxane, low-polarity

| ID | df (mm) | Temp Limits (°C) | 60 m | 75 m | 105 m |
|---------|---------|------------------|-----------------|-----------------|-----------------|
| | | | Part No. | Part No. | Part No. |
| 0.25 mm | 1.40 | 0 to 250/270 | N9316498 | | |
| 0.45 mm | 2.55 | 0 to 250/270 | | N9316188 | N9316189 |
| 0.53 mm | 3.00 | 0 to 250/270 | | | N9316190 |

Elite-RX: Drugs of Abuse

Application: Analysis of drugs of abuse

| Phase | ID | df (mm) | Temp Limits (°C) | 12 m | 25 m |
|-----------|---------|---------|------------------|-----------------|-----------------|
| | | | | Part No. | Part No. |
| Elite-1 | 0.20 mm | 0.33 | -60 to 330/350 | N9316345 | N9316346 |
| Elite-5ms | 0.20 mm | 0.33 | -60 to 330/350 | N9316349 | N9316350 |
| Elite-17 | 0.20 mm | 0.33 | 40 to 300/320 | N9316347 | N9316348 |

Elite-Betacylodextrin: Chiral Separations

Description: General-purpose chiral, Chiral compounds in essential oils

| Column Type | ID | df (mm) | Temp Limits (°C) | 30 m |
|------------------|---------|---------|------------------|-----------------|
| | | | | Part No. |
| Elite-Betacydex | 0.25 mm | 0.25 | 40 to 230 | N9316319 |
| Elite-Cyclosil B | 0.25 mm | 0.25 | 40 to 230 | N9316545 |

Elite-608

Application: Analysis of semivolatile pesticides by U.S. EPA method 608

Phase: Phenyl methyl polysiloxane, mid-polarity

| ID | df (mm) | Temp Limits (°C) | 60 m | 75 m | 105 m |
|---------|---------|------------------|-----------------|-----------------|-----------------|
| | | | Part No. | Part No. | Part No. |
| 0.32 mm | 0.50 | 40 to 290/310 | | N9316191 | |
| 0.45 mm | 0.42 | 40 to 270/290 | N9316194 | N9316195 | N9316189 |
| | 0.70 | 40 to 260/280 | N9316192 | N9316193 | N9316190 |
| 0.53 mm | 0.50 | 40 to 270/290 | N9316198 | N9316199 | |
| | 0.83 | 40 to 260/280 | N9316196 | N9316197 | |

Elite-SimDist

Application: Simulated distillation

Phase: Specially processed dimethylpolysiloxane, non-polar

| ID | df (mm) | Temp Limits (°C) | 10 m |
|---------|---------|------------------|-----------------|
| | | | Part No. |
| 0.45 mm | 2.55 | -60 to 360 | N9316261 |
| 0.53 mm | 3.00 | -60 to 360 | N9316262 |

CAPILLARY COLUMNS - SPECIALTY PHASES

Elite-SimDist HT (High Temp)

Application: High temperature simulated distillation

Phase: Metal Column, 100% dimethylpolysiloxane, non-polar

| | | | 6 m |
|--------|---------|------------------|-----------------|
| ID | df (mm) | Temp Limits (°C) | Part No. |
| 0.53mm | 0.15 | -60 to 400 | N9316572 |

Elite-TPH

Application: Analysis of total petroleum hydrocarbons

Phase: (5%-diphenyl)-dimethylpolysiloxane, low polarity

| | | | 30 m |
|---------|---------|------------------|-----------------|
| ID | df (mm) | Temp Limits (°C) | Part No. |
| 0.32 mm | 0.25 | -10 to 320 | N9316386 |
| 0.45 mm | 1.00 | -10 to 290 | N9316387 |

Elite-PONA

Application: Detailed analysis of petroleum naphtha

Phase: Specially processed dimethylpolysiloxane, non-polar

| | | 50 m | | 100 m |
|---------|---------|------------------|-----------------|-----------------|
| ID | df (mm) | Temp Limits (°C) | Part No. | Part No. |
| 0.20 mm | 0.50 | -60 to 300/320 | N9316065 | |
| 0.25 mm | 0.50 | -60 to 300/320 | | N9316015 |

Elite-FFAP

Application: Free fatty acids

Phase: Nitroterephthalic acid modified PEG (bonded), polar

| | | | 15 m | 30 m |
|---------|---------|------------------|-----------------|-----------------|
| ID | df (mm) | Temp Limits (°C) | Part No. | Part No. |
| 0.25 mm | 0.25 | 40 to 250 | N9316351 | N9316352 |
| 0.32 mm | 0.25 | 40 to 250 | N9316353 | N9316354 |
| 0.45 mm | 0.85 | 40 to 240/250 | N9316355 | N9316356 |
| 0.53 mm | 1.00 | 40 to 240/250 | N9316357 | N9316358 |

Elite-23

Application: Analysis of cis/trans isomers in FAMES and dioxins.

Equivalent to USP G8, G48.

Phase: (5%-cyanopropylphenyl)-biscyanopropylpolysiloxane

| | | 50 m | | 100 m |
|---------|---------|------------------|-----------------|-----------------|
| ID | df (mm) | Temp Limits (°C) | Part No. | Part No. |
| 0.25 mm | 0.15 | | | N9316507 |
| | 0.25 | | N9316506 | N9316508 |

Elite-MTBE

Application: Analysis of methyl t-butylether and other oxgenates

Phase: Proprietary low polarity phase

| | | | 30 m |
|---------|---------|------------------|-----------------|
| ID | df (mm) | Temp Limits (°C) | Part No. |
| 0.45 mm | 2.55 | 10 to 250 | N9316520 |
| 0.53 mm | 3.00 | 10 to 250 | N9316521 |

Elite-2560

Application: Application-specific column for cis/trans FAMES

Phase: Biscyanopropylpolysiloxane, Highly Polar

| | | | 100 m |
|---------|---------|------------------|-----------------|
| ID | df (mm) | Temp Limits (°C) | Part No. |
| 0.25 mm | 0.20 | | N9311570 |

Elite-Alumina/KCI* PLOT

| Inner Diameter (mm i.d.) | Length (mm) | Film Thickness (µm) | Temperature Limits (°C) | Part No. |
|--------------------------|-------------|---------------------|-------------------------|-----------------|
| 0.53 | 50 | | up to 200 | N9316544 |

* Lower Polarity than Elite Alumina.

Elite-Alumina PLOT Phase for Analysis of Light Hydrocarbons

| Inner Diameter (mm i.d.) | Length (mm) | Film Thickness (µm) | Temperature Limits (°C) | Part No. |
|--------------------------|-------------|---------------------|-------------------------|-----------------|
| 0.53 | 30 | | -60 to 200 | N9316304 |
| 0.53 | 50 | | -60 to 200 | N9316305 |

Note: -60 °C is the lowest temperature used on this phase in our lab. Lower temperatures may be used depending on the sample.

Elite-Cyclosil B PLOT for Chiral Separations

| Inner Diameter (mm i.d.) | Length (mm) | Film Thickness (µm) | Temperature Limits (°C) | Part No. |
|--------------------------|-------------|---------------------|-------------------------|-----------------|
| 0.25 | 30 | 0.25 | 35 to 230 | N9316545 |
| 0.32 | 30 | 0.25 | 35 to 230 | N9316546 |

Elite-Molesieve PLOT Phase for Analysis of Permanent Gases

| Inner Diameter (mm i.d.) | Length (mm) | Film Thickness (µm) | Temperature Limits (°C) | Part No. |
|--------------------------|-------------|---------------------|-------------------------|-----------------|
| 0.53 | 30 | N/A | -60 to 300 | N9316361 |

Note: -60 °C is the lowest temperature used on this phase in our lab. Lower temperatures may be used depending on the sample.

Elite-Q PLOT Phase for Analysis of Light Gases and Hydrocarbons

| Inner Diameter (mm i.d.) | Length (mm) | Film Thickness (µm) | Temperature Limits (°C) | Part No. |
|--------------------------|-------------|---------------------|-------------------------|-----------------|
| 0.32 | 30 | | -60 to 250 | N9316359 |
| 0.53 | 30 | | -60 to 250 | N9316360 |

Note: -60 °C is the lowest temperature used on this phase in our lab. Lower temperatures may be used depending on the sample.

Velocity-1, Velocity-5, and Velocity-Wax

PerkinElmer Velocity columns are excellent for standard daily test applications. They combine quality and affordability with reproducible results.

Features and Benefits

- Excellent results for theoretical plates, selectivity, & tailing factor tests
- Robust column cage
- Low baseline noise

Velocity-1 — 100% Dimethyl Polysiloxane

General purpose columns with a highly versatile phase that is extremely rugged, exhibiting long column lifetime, and high operating temperatures. Ideal for the analysis of non-polar petrochemical samples, such as detailed hydrocarbon analysis, hydrocarbon gases, petroleum oxygenates, petroleum aromatics, fuels, waxes, oils, sulfur compounds, mercaptans, and carbon disulfide. It also is an excellent phase for solvents, chemicals, flavors, fragrances, essential oils, air toxins, chlorofluorocarbons, arson analysis, pesticides, and hydrocarbons. Thermal stability up to 350 °C.

| Description | Dimensions | Part No. |
|-------------|--------------------------|-----------------|
| Velocity-1 | 15 M x 0.25 mm x 0.25 µm | N9306319 |
| Velocity-1 | 15 M x 0.25 mm x 1.00 µm | N9306310 |
| Velocity-1 | 30 M x 0.25 mm x 0.25 µm | N9306312 |
| Velocity-1 | 30 M x 0.25 mm x 1.00 µm | N9306323 |
| Velocity-1 | 30 M x 0.32 mm x 0.25 µm | N9306318 |
| Velocity-1 | 30 M x 0.32 mm x 1.00 µm | N9306321 |
| Velocity-1 | 30 M x 0.32 mm x 3.00 µm | N9306329 |
| Velocity-1 | 60 M x 0.25 mm x 0.25 µm | N9306320 |
| Velocity-1 | 60 M x 0.25 mm x 1.00 µm | N9306328 |
| Velocity-1 | 60 M x 0.32 mm x 1.00 µm | N9306324 |

Velocity-5 — 5% Diphenyl and 95% Dimethyl Polysiloxane

This column is ideal for general purpose analysis of drugs, pesticides, hydrocarbons, essential oils and semi-volatiles and solvent impurities. Low polarity phase with thermal stability up to 350°C.

| Description | Dimensions | Part No. |
|-------------|--------------------------|-----------------|
| Velocity-5 | 15 M x 0.32 mm x 0.25 µm | N9306325 |
| Velocity-5 | 30 M x 0.25 mm x 0.25 µm | N9306311 |
| Velocity-5 | 30 M x 0.32 mm x 0.25 µm | N9306313 |
| Velocity-5 | 30 M x 0.32 mm x 1.00 µm | N9306316 |
| Velocity-5 | 30 M x 0.53 mm x 0.50 µm | N9306326 |
| Velocity-5 | 30 M x 0.53 mm x 1.50 µm | N9306327 |

Velocity-Wax — Polyethylene Glycol

This column is ideal for intermediate to high polarity compounds. Thermal stability up to 250 °C.

| Description | Dimensions | Part No. |
|--------------|--------------------------|-----------------|
| Velocity-Wax | 30 M x 0.32 mm x 0.25 µm | N9306314 |
| Velocity-Wax | 30 M x 0.25 mm x 0.25 µm | N9306315 |
| Velocity-Wax | 30 M x 0.32 mm x 0.50 µm | N9306317 |
| Velocity-Wax | 30 M x 0.53 mm x 1.00 µm | N9306322 |





**ROBUST
RELIABLE
REPRODUCIBLE**

Custom Packed Columns

Design your own custom packed column in 3 easy steps:

- Choose your preferred column material (glass or metal)
- Select the length, diameter, phase, solid support, mesh and quantity
- Add your contact information and submit your quote request

It's that easy! We can supply any combination of support and liquid phase listed on our online ordering form. If your laboratory requires something that is not listed on our form, we will make every effort to find a solution to meet your needs.

- Custom packed columns for PerkinElmer, Agilent®, Thermo Scientific®, and other GC instruments
- Over 300+ Stationery Phases
- Over 100+ Solid Supports

To get your custom quote today fill out our online form:

<http://www.perkinelmer.com/tools/custompackedcolumn.aspx>

Replacement Column Sets For Standard Arnel Engineered Analyzers

Why would you compromise your gas chromatography by accepting cheap substitutes when replacing the columns in your Arnel Analyzer? Use only genuine PerkinElmer column sets as replacements to meet your specific chromatographic needs.

Don't see what you need?

Please contact your local PerkinElmer sales representative for replacement column sets for Custom Engineered Arnel Analyzers or for more information about our Arnel Engineered Solutions Analyzers.

Replacement Column Sets for Standard Arnel Refinery Gas Analyzers

| Description | For Standard Model | Part No. |
|--|--------------------|-----------------|
| Replacement column set for the Arnel RGA | 1015 | N6107032 |
| Replacement column set for the Arnel RGA | 1116 | N6107033 |
| Replacement column set for the Arnel RGA | 1115 | N6107033 |
| Replacement column set for the Arnel RGA | 1117 | N6107033 |
| Replacement column set for the Arnel RGA | 1215 | N6107032 |
| Replacement column set for the Arnel RGA | 1315 | N6107033 |
| Replacement column set for the Arnel RGA | 1317 | N6107033 |
| Replacement column set for the Arnel RGA | 1515 | N6107033 |

Note: Column sets are sold only as spares with an order, or as replacements for installed analyzers.

Replacement Column Sets for Standard Arnel Natural Gas Analyzers

| Description | For Standard Model | Part No. |
|--|--------------------|-----------------|
| Replacement column set for the Arnel NGA | 2001 | N6107040 |
| Replacement column set for the Arnel NGA | 2002 | N6107048 |
| Replacement column set for the Arnel NGA | 2003 | N6107052 |
| Replacement column set for the Arnel NGA | 2006 | N6107056 |
| Replacement column set for the Arnel NGA | 2008 | N6107060 |
| Replacement column set for the Arnel NGA | 2101 | N6107041 |
| Replacement column set for the Arnel NGA | 2103 | N6107053 |
| Replacement column set for the Arnel NGA | 2106 | N6107057 |
| Replacement column set for the Arnel NGA | 2108 | N6107061 |
| Replacement column set for the Arnel NGA | 2201 | N6107040 |
| Replacement column set for the Arnel NGA | 2203 | N6107052 |
| Replacement column set for the Arnel NGA | 2206 | N6107056 |
| Replacement column set for the Arnel NGA | 2208 | N6107060 |
| Replacement column set for the Arnel NGA | 2301 | N6107041 |
| Replacement column set for the Arnel NGA | 2303 | N6107053 |
| Replacement column set for the Arnel NGA | 2306 | N6107057 |
| Replacement column set for the Arnel NGA | 2406 | N6107056 |
| Replacement column set for the Arnel NGA | 2501 | NR002500 |
| Replacement column set for the Arnel NGA | 2503 | NR002503 |

Note: Column sets are sold only as spares with an order, or as replacements for installed analyzers.

Replacement Column Sets for Other Standard Arnel Analyzers

| Description | For Standard Model | Part No. |
|------------------------|--------------------|-----------------|
| Replacement column set | 4001 | N6107070 |
| Replacement column set | 4002 | N6107070 |
| Replacement column set | 4003 | N6107072 |
| Replacement column set | 4004 | N6107073 |
| Replacement column set | 4005 | N6107073 |
| Replacement column set | 4012 | N6107216 |
| Replacement column set | 4013 | N6107218 |
| Replacement column set | 4016 | N6107221 |
| Replacement column set | 4017 | N6107222 |
| Replacement column set | 4019 | N6107224 |
| Replacement column set | 4020 | N6107075 |
| Replacement column set | 4021 | N6107225 |
| Replacement column set | 4022 | N6107076 |
| Replacement column set | 4024 | N6107226 |
| Replacement column set | 4025 | N6107208 |
| Replacement column set | 4027 | N6107208 |
| Replacement column set | 4028 | N6107208 |
| Replacement column set | 4029 | N6107208 |
| Replacement column set | 4030 | NR004030 |
| Replacement column set | 4031 | NR004031 |
| Replacement column set | 4032 | N6107227 |
| Replacement column set | 4033 | N6107228 |
| Replacement column set | 4034 | N6107229 |
| Replacement column set | 4035 | N6107230 |
| Replacement column set | 4036 | N6107230 |
| Replacement column set | 4037 | N6107232 |
| Replacement column set | 4038 | NR004038 |
| Replacement column set | 4040 | NR004040 |
| Replacement column set | 4041 | NR004041 |
| Replacement column set | 4043 | NR004043 |
| Replacement column set | 4044 | NR004044 |
| Replacement column set | 4045 | NR004045 |
| Replacement column set | 4046 | NR004046 |
| Replacement column set | 4083 | NR004083 |
| Replacement column set | 4086 | NR004086 |
| Replacement column set | 4087 | NR004087 |
| Replacement column set | 4227 | N6107208 |
| Replacement column set | 4425 | N6107208 |
| Replacement column set | 4428 | N6107208 |
| Replacement column set | 4429 | N6107208 |
| Replacement column set | 4430 | NR004030 |
| Replacement column set | 4431 | NR004031 |
| Replacement column set | 4438 | NR004038 |
| Replacement column set | 4629 | NR004229 |

Note: Column sets are sold only as spares with an order, or as replacements for installed analyzers.

Unless otherwise noted all columns are available for the Clarus, AutoSystemXL and AutoSystem GC.

Calibration Gas Blends

Our calibration gas blends were formulated to be used exclusively in our Refinery and Natural Gas Analyzers. These are the same test gases that are used in the verification and validation processes that take place at our factory. Please contact your local PerkinElmer sales representative for more information about the composition of the gas blends.

| Description | Part No. |
|---|-----------------|
| RGA Calibration Blend With Syringe Adapter; 14L Cylinder @ 120 psi | N6107198 |
| RGA Calibration Blend Without Adapter; 14L Cylinder @ 120 psi | N6107199 |
| NGA Calibration Blend With Syringe Adapter; 14L Cylinder @ 240 psi | N6107200 |
| NGA Calibration Blend Without Adapter; 14L Cylinder @ 240 psi | N6107201 |

Arnel

We have an APP for that!

The **Arnel Group** within PerkinElmer Gas Chromatography is responsible for providing complete engineered solutions for a wide array of often encountered analytical problems. Do you have the need for a custom solution to perform ASTM or other regulated methods in your lab? Some of the types of analyzers Arnel has supplied are found in the list of categories shown here:

Natural Gas / NGL

Condensates

LPG

Refinery / Light Hydrocarbon Gas

Olefins

Aromatics

Oxygenates

Industrial Solvents

Naphthas

Gasoline

Distillates

Lube Oils / Waxes

Crude Oils

Asphalt

Bulk Gases

Trace Gases

TOGA

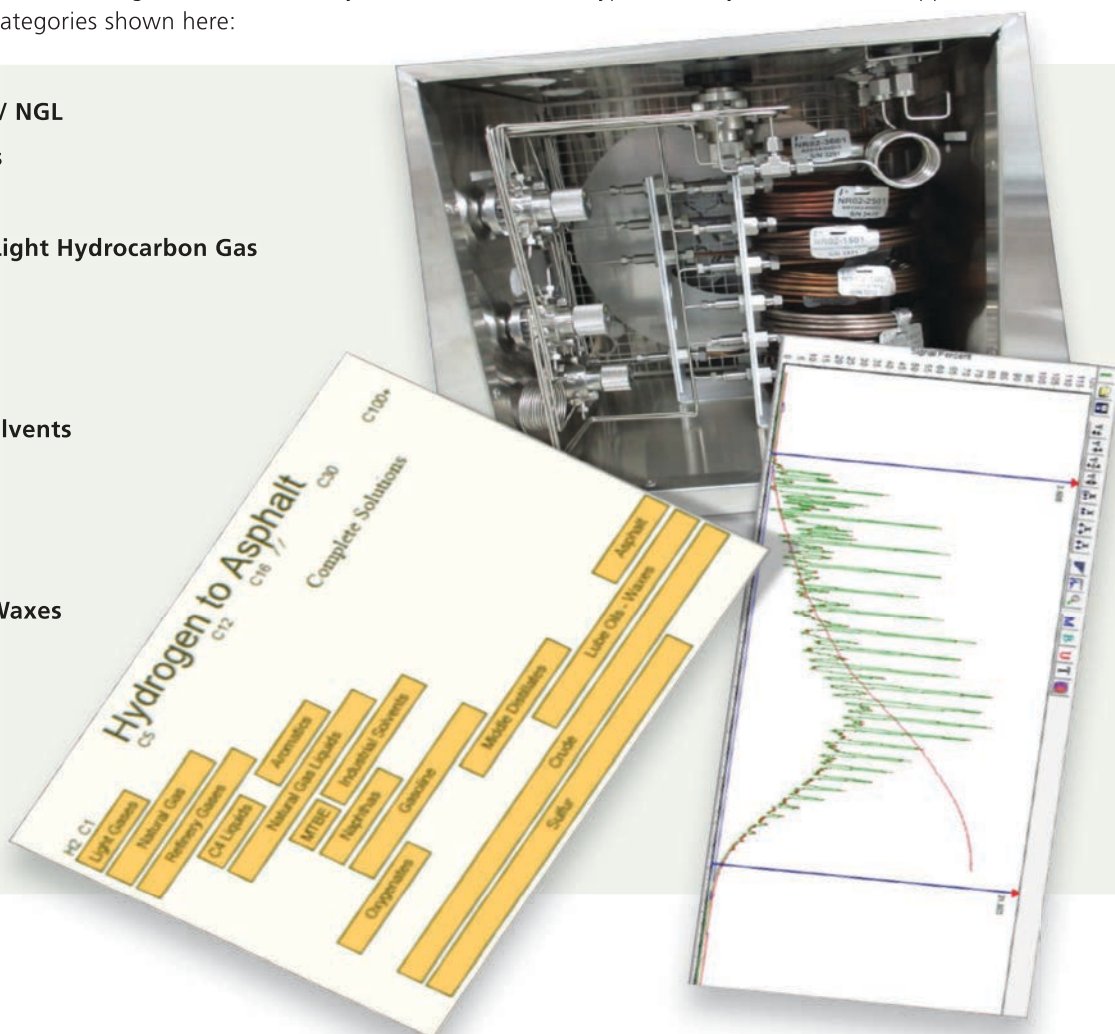

Ask Your Local PerkinElmer Sales Rep about our Product Catalog!

SilTite™ metal ferrules

Provide a continuous leak-free connection and are perfect for connecting your column to a GC/MS.

The SilTite™ metal ferrule and nut are manufactured from the same material and therefore expand and contract at the same rate, eliminating the need to retighten – even after temperature cycling. The base of the SilTite™ ferrule forms a perfect seal with the MS interface, ensuring a leak-free connection. SilTite™ metal ferrules have a temperature limit well above the temperature capacity of the injector, MS interface or GC oven.



| Description | Hole Size | Part No. |
|--------------------------------|-----------|-----------------|
| SilTite™ Ferrules Starter Kit* | 0.4 mm | N9306090 |
| SilTite™ Ferrules Starter Kit* | 0.5 mm | N9306091 |
| SilTite™ Ferrules Starter Kit* | 0.8 mm | N9306092 |
| SilTite™ Ferrules (pkg. 10) | 0.4 mm | N9306093 |
| SilTite™ Ferrules (pkg. 10) | 0.5 mm | N9306094 |
| SilTite™ Ferrules (pkg. 10) | 0.8 mm | N9306095 |
| SilTite™ Nuts (pkg. 5) | | N9306096 |

* Kits include 2 nuts and 10 ferrules

Capillary column ferrules

Graphite

Ferrule of choice for high-temperature applications up to 450 °C. Graphite seals easily and does not stick to glass columns.

Graphite/Vespel®

15% graphite / 85% polyimide ferrule recommended for use with GC/MS systems. Temperature limit is 350 °C.

Vespel®

Not reusable. Not recommended for fused silica capillary columns. Use these ferrules on 1/16 inch metal tubing and glass-lined receivers. Temperature limit is 350 °C.

| Size | Column i.d. / Ferrule i.d. | Graphite Part No. | Graphite/Vespel® Part No. |
|---------|----------------------------|-------------------|---------------------------|
| 1/16 in | 0.18 – 0.25 mm / 0.4 mm | | 09920104 |
| 1/16 in | 0.18 – 0.32 mm / 0.5 mm | 09903700 | 09920105 |
| 1/16 in | 0.18 – 0.32 mm / 0.5 mm** | N9306001 | N9306000 |
| 1/16 in | 0.18 – 0.53 mm / 0.8 mm | 09920141 | 09920107 |
| 1/8 in | 0.18 – 0.53 mm / 1.0 mm | 09903394 | |
| 1/8 in | 0.18 – 0.32 mm / 0.5 mm** | 09903395 | |
| 1/8 in | 0.18 – 0.32 mm / 0.5 mm | 09903981 | |

** 2-hole

Wide-bore adapter kit

Contains all the parts necessary to adapt to packed column injectors quickly and easily for use with wide-bore capillary columns.

Includes 0–20 mL/min flow controller element, wide-bore adapter with 1/16 inch fitting, wide-bore glass liner and column support hanger.

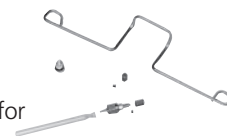

| Description | Part No. |
|-----------------------|-----------------|
| Wide-Bore Adapter Kit | N6120001 |

Universal connectors



| Dimension | Part No. |
|---|-----------------|
| Universal Connector (pkg. 5) | N9302149 |
| Metal Universal Connectors: 0.25 mm i.d. (pkg. 10) | N9301167 |
| Universal Y Splitter (pkg. 1) | N9303448 |
| Polyimide Sealing Resin (5 g) | N9301343 |
| Undeactivated Presstight Column Connectors (pkg. 5) | N9303962 |

Wafer scribes

The PerkinElmer ceramic wafer scribe is inexpensive and ideal for cutting polyimide fused silica capillary columns and guard columns. The scribe is easy to hold and simple to use. All four sides can be used as a cutting tool.



| Dimension | Part No. |
|-------------------------|-----------------|
| Wafer Scribes (pkg. 10) | N9301376 |

Swagelok™ Fittings











Swagelok fittings from PerkinElmer are available in brass and stainless steel.

The patented advanced-geometry back ferrule design provides a leak-tight tube connection on all Swagelok™ stainless steel tube fittings, in sizes 1/4 to 1/2 in., and 6 to 12 mm. Leak-tight seals that will withstand high-pressure, vibration, vacuum and temperature changes depend upon close tolerances and consistent, exacting quality control in conjunction with good design principles.

Features and Benefits

- Ease of installation
- Back ferrule axially advances the front ferrule
- Vibration fatigue resistance
- Wide variety of configurations

Swagelok™ Fittings

| Product | Qty. | Size | Brass Part No. | Stainless Steel Part No. |
|--|--------|-----------------------------|----------------|--------------------------|
| Bulkhead Adapter  | 1 | 1/4 in. to 1/4 in. tube | | N9301267 |
| Back Ferrule  | pkg. 5 | 1/16 in. | N9300040 | N9300042 |
| | | 1/8 in. | N9300036 | N9300038 |
| | | 1/4 in. | N9300030 | N9300032 |
| Cross Union  | pkg. 1 | 1/8 in. | N9301259 | |
| Front Ferrule  | pkg. 5 | 1/16 in. | N9300041 | N9300043 |
| | | 1/8 in. | N9300037 | N9300039 |
| | | 1/4 in. | N9300031 | N9300033 |
| Male Adapter Tube to Pipe  | pkg. 1 | 1/4 in. tube to 1/8 in. NPT | N9301266 | |
| Male Connector  | pkg. 1 | 1/8 in. to 1/8 in. NPT | N9301253 | |
| | | 1/8 in. to 1/4 in. NPT | N9301254 | |
| | | 1/4 in. to 1/8 in. NPT | N9301255 | |
| | | 1/4 in. to 1/4 in. NPT | N9301269 | |
| Nut  | pkg. 5 | 1/16 in. | N9300058 | N9300059 |
| | | 1/8 in. | N9300056 | N9300057 |
| | | 1/4 in. | N9300054 | N9300055 |
| Plug  | pkg. 1 | 1/16 in. | | N9300053 |
| | | 1/8 in. | N9300060 | N9300061 |
| | | 1/4 in. | N9301268 | N9301233 |
| Union  | pkg. 2 | 1/16 in. | N9300048 | N9300049 |
| | | 1/8 in. | N9300046 | N9300047 |
| | | 1/4 in. | N9300044 | |
| Union Tee  | pkg. 1 | 1/16 in. | N9301221 | |
| | | 1/8 in. | N9301222 | |
| | | 1/4 in. | N9301223 | |
| Reducing Union  | pkg. 1 | 1/8 in. to 1/16 in. | N9300051 | N9301225 |
| | | 1/4 in. to 1/8 in. | N9300050 | N9301226 |
| | | 1/4 in. to 1/16 in. | N9301227 | |

REFINE YOUR GC PATH

Swafer Micro-Channel Wafer Technology

PerkinElmer's Swafer™ micro-channel wafer technology is an innovative and user-friendly approach for flowswitching and splitting applications. It delivers unparalleled hardware and application flexibility, expanding the capabilities of capillary gas chromatography (GC).



Features and Benefits:

- Allows you to tackle difficult or otherwise impossible separations, delivering richer sample information which was previously unattainable
- User-friendly design and user-defined oven position allow easy setup and configuration changes, without requiring service intervention
- Complete independence of the column from injectors or detectors lets you combine injection techniques (headspace, thermal desorption, liquid, ect.), based on sample requirements
- 15 user-interchangeable configurations deliver over 18 possible modes of operation for unparalleled application flexibility
- Can be used on any Clarus 580/500 or 680/600 GC with programmable pneumatic control (PPC)
- Vent unwanted solvent or other large peak from chromatogram
- Tweak the column polarity with serial column for difficult separations

Swafer Kits for New Clarus GC Systems

| Description | Part No. |
|--|-----------------|
| D-Swafer Complete Kit – for Clarus GC units only (for Clarus 680/580 GCs with PPC) Includes all required installation hardware user guides, and the D-Swafer. | N6520273 |
| S-Swafer Complete Kit – for Clarus GC units only (for Clarus 680/580 GCs with PPC) Includes all required installation hardware, user guides, and the S-Swafer. | N6520272 |

Swafer Kits and Accessories for Existing Clarus GC Systems

| Description | Part No. |
|--|-----------------|
| Micro-Channel Kit for Existing Clarus 680/600/580/500 GC with PPC. Includes all hardware required to install a Swafer. The Swafer and installation are not included and must be purchased separately. | N6520270 |
| Micro-Channel Kit for Existing Clarus 680/600/580/500 GCs with PreVent currently installed. If PreVent is already included in the GC configuration, this hardware kit provides the additional parts required to install a Swafer. The Swafer and installation are not included and must be purchased separately. | N6520271 |
| D-Swafer Dean's Switch (Swafer only) | N9306251 |
| S-Swafer Splitter (Swafer only) | N9306262 |

HOW CAN THE SWAFER HELP YOU?

Enhanced Sample Information

| | | |
|----------------------|--|----------------------|
| Solvent venting | Vent unwanted solvent or other large peak from chromatogram | D-Swafer S-Swafer |
| Detector switching | Switch between your detectors of choice anytime during the run or between injections | D-Swafer |
| Column switching | Make your GC more flexible by choosing which column should be used to chromatograph the injected sample | D-Swafer |
| Heartcutting | Cut your chromatogram and analyze the cut on a different column for a better separation | D-Swafer |
| Polarity tuning | Tweak the column polarity with serial column for difficult separations | D-Swafer S-Swafer |
| Column selection | Better utilize large and expensive detectors by choosing which of the two columns to monitor | D-Swafer |
| Carrier-gas swapping | Use a different carrier gas in the injector or sampling system from that used for the chromatography | D-Swafer |
| Peak attenuation | Analyze a wide dynamic range by diluting portions of your chromatography | D-Swafer |
| Splitting | Split your chromatography between up to four channels (detectors, sniffer ports, etc.) for additional sample information | S-Swafer |

Throughput and Maintenance

| | | |
|---|---|----------------------|
| Column backflushing | Remove unwanted compounds from the column after the analytes have eluted | D-Swafer S-Swafer |
| MS isolation | Perform your MS, column and inlet maintenance without venting for less downtime | D-Swafer S-Swafer |
| Retention-gap purging | Remove large amounts of solvent with cold on-column injection | D-Swafer |
| Inlet selection | Automate your inlet choices (headspace, thermal desorption, liquid autosampler, etc.) between injections | D-Swafer |
| Injector maintenance or enhanced large volume injection | Enable injector septa or liner exchange while the system is still active Prevent solvent vapor from entering column and detector during injector purging | D-Swafer S-Swafer |

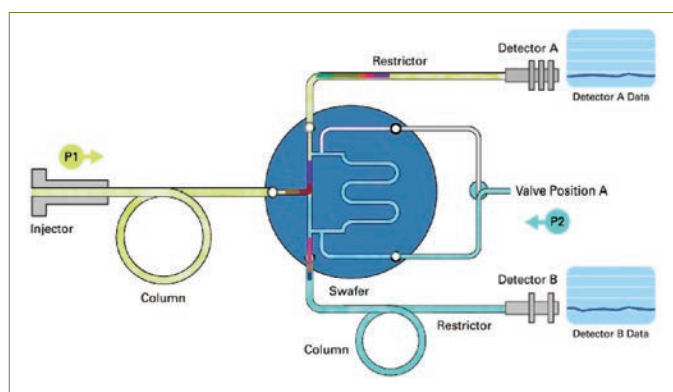

Heartcutting (D-Swafer) allows separation of selected peaks within a complex sample matrix.

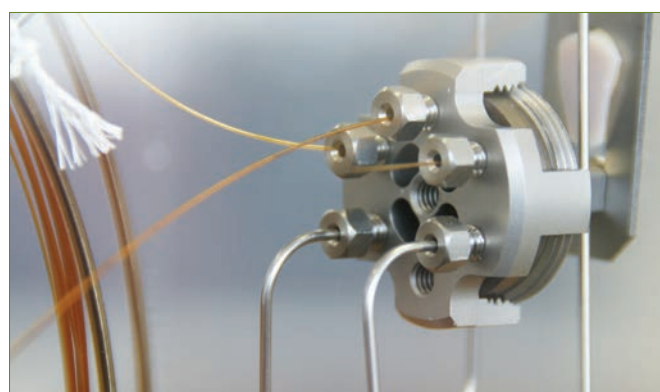

Swafer can be installed in any Clarus S80/S00 or 680/600 GC with programmable pneumatic control (PPC).

Manual Gas Control

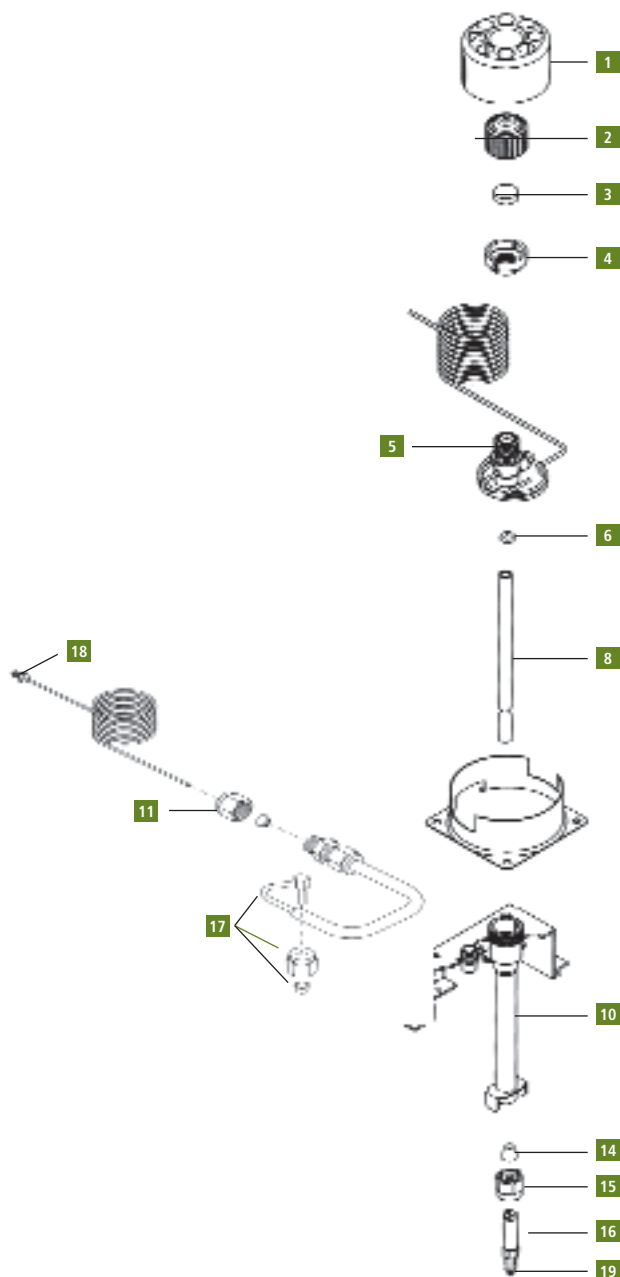

Injector Replacement Parts

| Component | Part No. |
|---|-----------------|
| 1 Injector Cover | N6101482 |
| 2 Septum Cap | N6100153 |
| 3 PerkinElmer Green Injection Septum (pkg. 50) | N6621028 |
| 4 Injector Top Nut | N6101358 |
| 5 Injector Head | N6100158 |
| O-Ring, Silicone for Glass Liner (pkg. 10) Maximum injector temperature 250 °C. | N6101374 |
| O-Ring, Graphite for Glass Liner (pkg. 5) Maximum injector temperature 450 °C. | N6101378 |
| 6 O-Ring, KALREZ® for Glass Liner (pkg. 1) Maximum injector temperature 450 °C. | N9302782 |
| O-Ring, Viton® for Glass liner (pkg. 1) Maximum injector temperature 250 °C, recommended for use with Mass Spec. ships with instrument | N9302783 |
| Quartz Liner (2 mm) for Splitless Operation | N6121002 |
| Quartz Liner (4 mm) for Split Operation or Large Volume Splitless Injection | N6121001 |
| Glass Liner (2 mm) for Splitless Operation | N6101372 |
| Glass Liner (4 mm) for Split Operation | N6101052 |
| 8 Deactivated Liner for Splitless Operation 2 mm, packed with wool. (pkg. 5) | N6121021 |
| Deactivated Liner for Split Operation 4 mm, packed with wool. (pkg. 5) | N6121020 |
| Deactivated Unliner 4 mm, packed with wool. (pkg. 5) | N6121022 |
| 10 Injector Body | N6100047 |
| 11 1/8 in. Swagelok™ Nut Brass (pkg. 5) | N9300056 |
| 12 Restrictor* | N6101034 |
| 13 1/8 in. Graphite/Vespel Ferrule (pkg. 10)* | 09920301 |
| 14 1/4 in. Graphite Ferrule (pkg. 10) | 09920140 |
| 15 1/4 in. Swagelok Nut, Stainless Steel (pkg. 5) | N9300055 |
| 16 Injector Adapter | N6100157 |
| 17 Charcoal Trap | N6100275 |
| Charcoal Trap for PPC Version** | N6100331 |
| 18 Split Vent Tube | N6100159 |
| 19 Column Nut 1/16 in. Long length for reversed ferrule (pkg. 5) | 09903392 |

** Not shown

Miscellaneous Accessories

| Component | Part No. |
|--|-----------------|
| 2 oz. Replacement Charcoal (30/60 mesh) | 03300904 |
| Column Ferrule Graphite/Vespel | 09920105 |
| Liner Removal Tool | N6100102 |
| Merlin Microseal Adapter Kit Includes: 2 Merlin Microseal septa, 1 nut, and 1 injection port adapter | N9303344 |
| Merlin Microseal Septa | N9303345 |
| Zero Dilution Liner (Inner) | N1011446 |
| Zero Dilution Liner (Outer) | N1011445 |

Split/Splitless Injector Add-On Kits

Capillary Injector with PPC

Kit includes split/splitless injector with programmable pneumatic control for carrier gas, split vent, heater, sensor, and heater block. The AutoSystem XL must be PPC™ ready. If not, a PPC upgrade kit (N6120146) is required. Installation by PerkinElmer Service is required, but not included.

| Voltage | Part No. |
|---------|-----------------|
| 120 V | N6120138 |
| 240 V | N6120139 |

Complete Capillary Injector Add-On Kits

Kit includes split/splitless injector in module with heater and sensor, 0-60 psi pressure regulator, and transducer for pressure readout. For manual gas control.

| Voltage | Part No. |
|------------------|-----------------|
| 120 V AutoSystem | N6120009 |
| 240 V AutoSystem | N6120022 |
| 120 V Clarus | N6520012 |
| 230 V Clarus | N6520013 |

Dual Capillary Column Adapter Kit

Kit includes all necessary hardware to install two capillary columns to a capillary injector. Note: kit does not include appropriate 1/8 in. 2-hole ferrule. (See page 200) For manual gas control.

| Voltage | Part No. |
|---------|-----------------|
| 120 V | N6120050 |

Split/Splitless Injector Starter Kit for Manual Gas Control

Includes: 2 mm i.d. quartz liner, 4 mm i.d. quartz liner, silicone O-Rings (10), green septa (50), 0.5 mm graphite ferrules (10), 0.8 mm graphite ferrules (10), 1/16 in. stainless steel nuts (5), untreated quartz wool, packing rod, and wafer scribes (10).

| Voltage | Part No. |
|---|-----------------|
| Split/Splitless Injector Starter Kit for Manual Gas Control | N6120101 |

Add-On Kits

Packed Column Injector Kit with Manual Pneumatics

Includes: complete injector assembly with heater and sensor, 0-100 mL flow controller, and column head pressure gauge for installation into the AutoSystem.

| Voltage | Part No. |
|---------|----------|
| 120 V* | N6120007 |
| 240 V* | N6120023 |

Packed Column Injector Kit with PPC

The kit includes complete injector assembly with programmable pneumatic control, heater, sensor, and heater block. The GC must be PPC™ ready. If not, a PPC upgrade kit (N6120146) is required.

| Voltage | Part No. |
|---------|----------|
| 120 V* | N6120136 |
| 240 V* | N6120137 |

Packed Column Injector Kit with Screen Readout and Manual Pneumatics

Includes: complete injector assembly with heater and sensor, 0-100 mL flow controller and column head pressure gauge, and transducer for screen readout of column carrier flow.

| Voltage | Part No. |
|-------------------|----------|
| 120 V* AutoSystem | N6120008 |
| 240 V* AutoSystem | N6120025 |
| 120 V* Clarus | N6520010 |
| 230 V* Clarus | N6520011 |

Packed Column Injector Kit AutoSystem XL and Clarus

The kit includes complete injector, heater, sensor, and heater block. (Does not include pneumatics.)

| Voltage | Part No. |
|---------|----------|
| 120 V* | N6120071 |
| 240 V* | N6120072 |

Packed Column Injector Starter Kit

Includes glass liner, needle guide, green septa (50), untreated quartz wool, and packing rod.

| Voltage | Part No. |
|------------------------------------|----------|
| Packed Column Injector Starter Kit | N6120100 |

*Service installation suggested

Injector Replacement Parts

| Description | Part No. |
|--|----------|
| 1 Septum Cap | N6100153 |
| 2 PerkinElmer Green Injection Septum (50/pack) | N6621028 |
| 3 Needle Guide | N6101050 |
| 4 Glass Liner | N6101048 |
| 4 Quartz Liner | N6121000 |
| 5 Packed Injector Assembly | N6100048 |

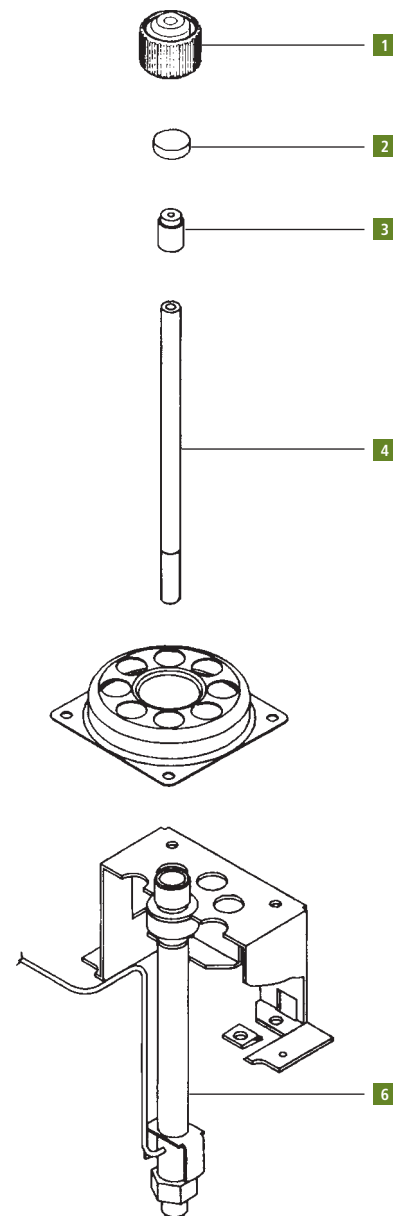

Miscellaneous Accessories

Injector/Detector Adapter 1/4 in.

Adapter fits on injector and detector outlet (inside oven) for use with 1/4 in. columns.

| Description | Part No. |
|-----------------------------------|-----------------|
| Injector/Detector Adapter 1/4 in. | 00080100 |

Liner Removal Tool

Allows easy removal of glass liners from injector port.

| Description | Part No. |
|--------------------|-----------------|
| Liner Removal Tool | N6100102 |

Silanized Glass Wool

Packing for wide-bore glass liners.



| Description | Part No. |
|------------------------------|-----------------|
| Silanized Glass Wool (2 oz.) | 03300905 |

Wide-Bore Adapter Kit

0.53 Capillary Column Adapter Kit

The AutoSystem Wide-Bore Adapter Kit allows conversion of the packed inlet for 0.53 mm capillary column operation. The kit includes 0-20 mL flow control element, wide-bore adapter with 1/16 in. fitting, wide-bore glass liner, and column support hanger. Can be used in both on-column and off-column modes of operation.

| Description | Part No. |
|-----------------------------------|-----------------|
| 0.53 Capillary Column Adapter Kit | N6120001 |

Convenient GC/MS Consumable Kits

| Description | Part No. |
|--------------------------------|-----------------|
| GC/MS PSS Injector Starter Kit | N6100447 |

| Contents | Pkg. | Qty. | Part No. |
|---|------|------|-----------------|
| 5.0 µL Autosampler Syringe | 1 | | N6101390 |
| Vial Locator (dongle) | 2 | | N6101182 |
| PSS Injector Viton o-rings (250 deg) | 10 | 1 | N6101747 |
| PSS Injector Kelrez o-rings (350 deg) | 1 | 10 | 09921004 |
| PSS Split/Splitless Injector, 2 mm, No Wool | 2 | | N6121004 |
| Graphite/Vespel Ferrules, for 0.25 mm Columns | 10 | 2 | 09920104 |
| PerkinElmer Green Speta (50 pieces) | 1 | | N6621028 |
| Marathon Filament | 1 | | N6470012 |
| Aluminum Oxide Powder (3 oz) | 1 | | 04190197 |

| Description | Part No. |
|--------------------------------|-----------------|
| GC/MS CAP Injector Starter Kit | N6100448 |

| Contents | Pkg. | Qty. | Part No. |
|---|------|------|-----------------|
| 5.0 µL Autosampler Syringe | 1 | | N6101390 |
| Vial Locator (Dongle) | 2 | | N6101182 |
| CAP Injector Viton o-rings (250 deg) | 10 | | N9302783 |
| CAP Injector Kelrez o-rings (350 deg) | 10 | | N9302782 |
| CAP Split/Splitless Injector, 4 mm, No Wool | 2 | | N6121004 |
| Graphite/Vespel Ferrules, for 0.25 mm Columns | 10 | 2 | 09920104 |
| PerkinElmer Green Speta (50 pieces) | 1 | | N6621028 |
| Marathon Filament | 1 | | N6470012 |
| Aluminum Oxide Powder (3 oz) | 1 | | 04190197 |

POC Replacement Parts

| Components | Part No. |
|--|----------|
| 1 Septum Cap | N6100153 |
| 2 PerkinElmer Green Injection Septum (50/pack) | N6621028 |
| 3 Needle Guide | N6101702 |
| 4 Liner/Hour Glass | N6101703 |
| 5 Body Assembly | N6100256 |

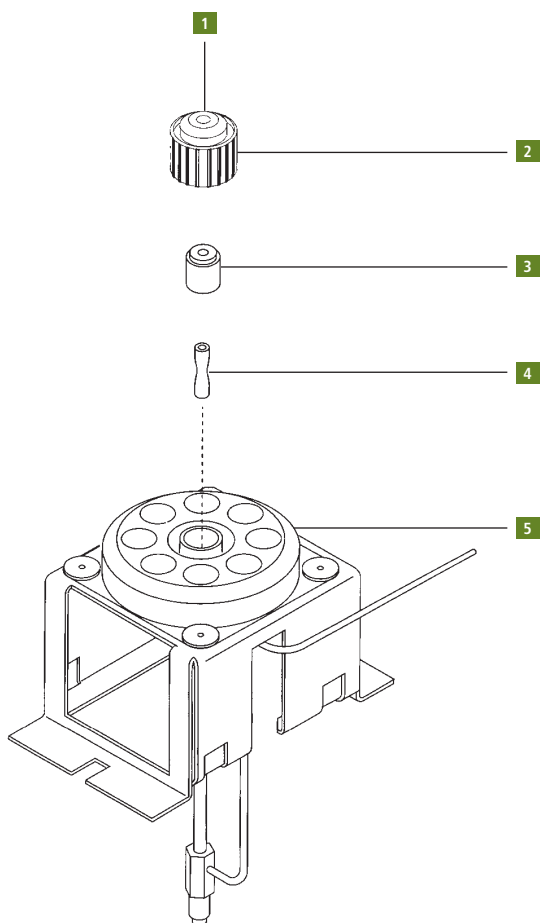

Programmed-Temperature On-Column Injector System

Packed Column Injector Kit with Manual Pneumatics

Programmed-Temperature On-Column (POC) Inlet is designed to be used with fused-silica capillary columns. The sample is injected onto the column while the inlet is cool. After the injection, the inlet begins to heat. This delay in heating avoids the flash vaporization associated with a normal injection. This explosive vaporization can cause thermal breakdown and/or discrimination of certain analytes, which can be avoided by using the POC.

The POC Injector is best used to achieve recovery of compounds of greater than C₆₀ (e.g., polywaxes). The POC utilizes flow control, producing the best recovery out to C₁₀₀ or greater.

POC Injector with Manual Flow Controller and Head Pressure Gauge

Kit includes all necessary hardware to install injector into AutoSystem Series or Clarus Series.

| Voltage | Part No. |
|---------|----------|
| 120 V* | N6120076 |
| 240 V* | N6120077 |

POC Injector with Manual Flow Controller and Head Pressure Gauge with Flow Readout on Screen

Kit includes all necessary hardware to install injector into AutoSystem Series or Clarus Series.

| Voltage | Part No. |
|---------|----------|
| 120 V* | N6120082 |
| 240 V* | N6120083 |

POC Injector with PPC Add-On Kit

Kit includes injector with programmable pneumatic control, heater, sensor, and heater block. The AutoSystem XL or Clarus GC must be PPCTM ready. If not, a PPC upgrade kit (N6120146) is required. Installation by PerkinElmer Service is required, but not included.

| Voltage | Part No. |
|---------|----------|
| 120 V* | N6120142 |
| 240 V* | N6120143 |

POC Injector Starter Kit

Includes: needle guides (5), universal connectors (5), 0.53 mm i.d. deactivated fused silica (5 m), 1/16 in. stainless steel nuts (5), 0.8 mm graphite ferrules (10), green septa (50), and wafer scribes (10).

| Voltage | Part No. |
|--------------------------|----------|
| POC Injector Starter Kit | N6120098 |

* Service installation suggested.

Programmed-Temperature Split/Splitless Injector System

PSS Injector Add-On Kits with Manual Pneumatics

The programmed-temperature split/splitless (PSS) inlet allows accurate sample delivery to a capillary column. The PSS allows the analysis of thermally labile compounds, while eliminating the discrimination of high-boiling compounds. One of the major advantages of the PSS is that any nonvolatile material will remain in the inlet liner and not on the front of the column.

PSS with pneumatics and pressure readout on screen. Kit includes all necessary hardware to install injector into GC.

| Voltage | Part No. |
|-------------------|-----------------|
| 120 V* AutoSystem | N6120074 |
| 240 V* AutoSystem | N6120075 |
| 120 V* Clarus | N6520014 |
| 230 V* Clarus | N6520015 |

PSS Injector with PPC

Kit includes injector with programmable pneumatic control, heater, sensor, and heater block. The GC must be PPC™ ready. If not, a PPC upgrade kit (N6120146) is required.

| Voltage | Part No. |
|---------|-----------------|
| 120 V* | N6120140 |
| 240 V* | N6120141 |

PSS Injector Starter Kit

Includes: universal connectors (5), 0.53 mm i.d. deactivated fused-silica (5 m), 2 mm i.d. quartz liner, 1 mm i.d. quartz liner, glass hourglass liner, 1/16 in. stainless steel nuts (5), 0.5 mm i.d. graphite ferrules (10), 0.8 mm i.d. graphite ferrules (10), Viton® O-Rings (6), graphite O-Rings (5), untreated quartz wool, wafer scribes (10), and green septa (50).

| Description | Part No. |
|--------------------------|-----------------|
| PSS Injector Starter Kit | N6120102 |

Zero Dilution Liners

Used together as set.

| Description | Part No. |
|-------------|-----------------|
| Inner Liner | N1011446 |
| Outer Liner | N1011447 |

* Service installation suggested.

PSS Replacement Parts

| Components | Part No. |
|---|-----------------|
| 1 Septum Cap | N6100153 |
| 2 Injector Cover | N6101482 |
| 3 PerkinElmer Green Injection Septum (pkg. 50) | N6621028 |
| 4 Trap, Charcoal – non PPC version PPC version (not shown) | N6100275 |
| 5 Nut | N6101705 |
| 6 Septum Purge | N6100260 |
| O-Ring Viton (pkg. 10) max. temp 250 °C, recommended for use with mass spec. Shipped with instrument. | N6101747 |
| 7 O-Ring KALREZ® (pkg. 1) max. temp. 450 °C | 09921004 |
| O-Ring Graphite (pkg. 5) max. temp. 450 °C | N6101751 |
| Quartz Liner, 2 mm Split Mode Shipped with instrument. | N6121004 |
| 8 Quartz Liner, 1 mm Splitless Mode | N6121006 |
| On-column liner | N6101539 |
| 9 Body Assembly | N6100261 |
| 10 Ferrule 1/8 in. x 1/16 in. (pkg. 10) | 09920301 |
| 11 Nut 1/8 in. | 09903128 |
| 12 Split Vent Line | N6100159 |
| 13 Purge Restrictor | N6101034 |
| 14 Nut | 09903392 |

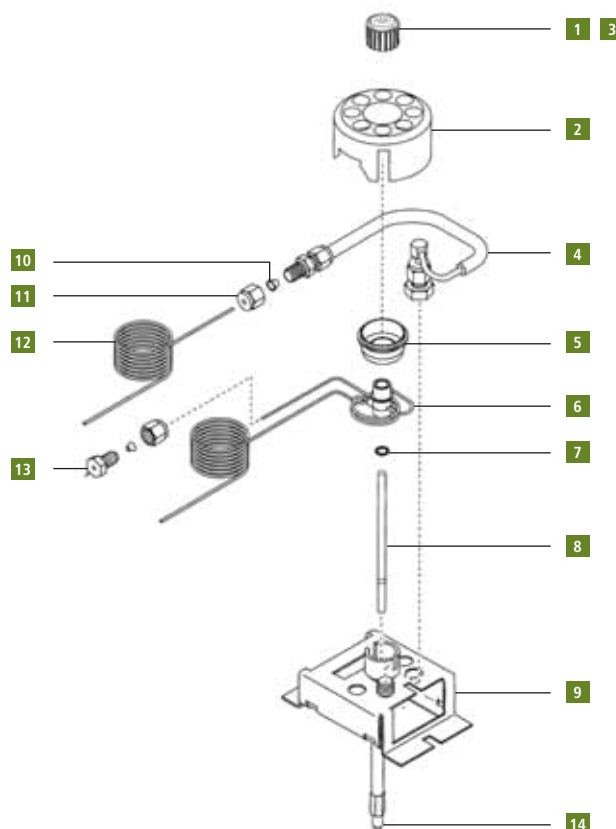

Glass Inlet Liners









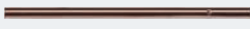

Inlet liners for split injection have mixing chambers with tortuous flow paths to allow full vaporization of the sample. Deactivating the surface of these liners prevents active compounds from degrading. Packing the liner with wool will trap non-volatile residue and prevent column contamination when analyzing dirty samples.

Inlet liners for splitless injection are generally designed as straight tubes, although new designs such as the gooseneck will help contain the sample in the injector. Packing these liners with wool will also help trap non-volatile residue and prevent column contamination.

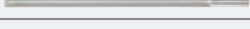

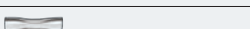



Capillary Split/Splitless Injector Liners

| | Description | ID mm | OD mm | Length mm | Pkg | Part No. |
|--|--|-------|-------|-----------|-----|-----------------|
| | Split Glass Liner Siltek Deactivated Surface Liner (with wool) – Universal liner for general purpose analyses. Surface provides inertness over a wide sample pH range. Wool can be adsorptive if fibers are broken | 4 | 6.2 | 92.1 | 5 | N6121020 |
| | Split Glass Liner (with wool) – Universal liner for general purpose analyses | 4 | 6.2 | 92.1 | 5 | N6502009 |
| | Split Siltek Deactivated Glass Liner (with wool) – Universal liner for general purpose analyses. Deactivated surface provides minimal bleed and inertness over a wide sample pH range | 4 | 6.2 | 92.1 | 5 | N6502010 |
| | Clarus Cup Split Glass Liner – Good for both high and low molecular weight compounds. Sample vaporization is aided by tortuous flow path and minimizes molecular weight discrimination. Difficult to clean | 4 | 6.2 | 92.1 | 5 | N6502011 |
| | Clarus Cycloplitter Glass Liner – Patented cylindrical design for dirty samples, easy to clean and allows many injections before cleaning is required. Not recommended for large volume injections | 4 | 6.2 | 92.1 | 5 | N6502012 |
| | Unliner Deactivated Glass Liner (with wool) – Universal liner for general purpose analyses | 4 | 6.2 | 92.1 | 5 | N6121022 |
| | Clarus Splitless Glass Liner – Low volume sample analyses, beneficial with headspace and purge/trap | 1 | 6.2 | 92.1 | 5 | N6502006 |
| | Quartz Liner for Splitless Operation (ships with instrument) – Standard injector liner | 2 | 6.2 | 92.1 | 1 | N6121002 |
| | Glass Liner for Splitless Operation – Universal liner for general purpose analyses | 2 | 6.2 | 92.1 | 1 | N6101372 |
| | Deactivated Glass Liner for Splitless Operation (with wool) – Good for analyses of trace samples | 2 | 6.2 | 92.1 | 5 | N6121021 |
| | Siltek Deactivated Liner (with wool) for Splitless Operation – Optimum sample dispersion for active samples. Surface provides inertness over a wide sample pH range. Wool can be adsorptive if fibers are broken | 2 | 6.2 | 92.1 | 5 | N6502004 |
| | Quartz Liner for Split Operation – Good for large volume injection samples | 4 | 6.2 | 92.1 | 1 | N6121001 |
| | Glass Liner for Split Operation – Universal liner for general purpose analyses | 4 | 6.2 | 92.1 | 1 | N6101052 |
| | Siltek Deactivated Double Gooseneck Glass Liner (with wool) – Optimum sample dispersion for active samples. Decreases breakdown of active compounds such as endrin and DDT. Chamber contains sample vaporization cloud. Not suitable for PPC systems | 4 | 6.2 | 92.1 | 5 | N6502003 |
| | Cyclo Double Gooseneck Liner for Split Operation – Cylindrical design for large volume and trace dirty samples. Decreases injection port discrimination. Cannot be packed with wool and more difficult to clean | 4 | 6.2 | 92.1 | 5 | N6502005 |
| | Zero Dilution Glass Outer Liner – Ideal for trace HS work. Use in conjunction with N1011446 | 2 | 6.3 | 90 | 1 | N1011445 |
| | Zero Dilution Glass Inner Liner – Ideal for trace HS work. Use in conjunction with N1011445 | | 2 | 73 | 1 | N1011446 |

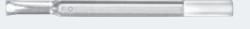

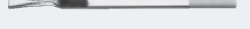

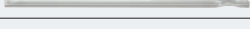

Programmed Temperature Split/Splitless (PSS) Injector Liners

| | Description | ID mm | OD mm | Length mm | Pkg | Part No. |
|---|--|-------|-------|-----------|-----|-----------------|
|  | Quartz Liner for Splitless operation (ships with instrument) – Excellent liner for low volume analyses | 1 | 4 | 86.2 | 1 | N6121006 |
|  | NEW! Siltek Deactivated Glass PSS Liner – Used for low volume trace sample analyses | 1 | 4 | 86.2 | 5 | N6502000 |
|  | Quartz Liner for Split operation (ships with instrument) – Approved PerkinElmer standard injector liner | 2 | 4 | 86.2 | 1 | N6121004 |
|  | NEW! Siltek Deactivated Glass Liner for Split operation (with wool) – Maximum inertness and packed with wool gives optimum sample dispersion. Surface provides inertness over wide sample pH range. Wool can be adsorptive if fibers are broken | 2 | 4 | 86.2 | 5 | N6502001 |
|  | NEW! Siltek Deactivated Glass Liner for Split operation – Max. inertness gives optimum sample dispersion. Deactivated surface provides minimal bleed and inertness over a wide sample pH range | 2 | 4 | 86.2 | 5 | N6502002 |
|  | Zero Dilution Outer Liner –Use in conjunction with N1011446 | 2.8 | 4 | 83 | 1 | N1011447 |
|  | Zero Dilution Inner Liner –Use in conjunction with N1011447 | | 2 | 73 | 1 | N1011446 |
|  | On-column Glass Liner | 2.4 | 4 | 86.2 | 1 | N6101539 |
|  | Liner/Hour Glass for POC Injector | 2.4 | 4 | 19.05 | 1 | N6101703 |
|  | Quartz Split Liner with Silanized Glass Wool | 2 | 4 | 86.2 | 1 | N6121008 |
|  | Quartz Split Liner with Silanized Glass Wool | 2 | 4 | 86.2 | 5 | N6121009 |

Packed Column Injector Liners

| | Description | ID mm | OD mm | Length mm | Pkg | Part No. |
|---|---|-------|-------|-----------|-----|-----------------|
|  | Drilled Uniliner (hole on top) – Excellent liner for high sample recovery and linearity, recommended for aqueous injections. Good for PPC equipped GCs | 4 | 6.2 | 92.1 | 5 | N6121022 |
|  | NEW! Drilled Uniliner (hole on bottom) – Recommended for analysis in which compounds of interest could be affected by a tailing solvent peak. Good for PPC equipped GCs | 4 | 6.2 | 92.1 | 5 | N6502013 |
|  | NEW! Gooseneck Drilled Uniliner (hole on top) – Use for trace, active samples, high recovery and linearity | 4 | 6.2 | 92.1 | 5 | N6502014 |
|  | NEW! Gooseneck Drilled Uniliner (hole on bottom) – Use for trace, active samples, high recovery and linearity | 4 | 6.2 | 92.1 | 5 | N6502015 |
|  | NEW! Open Top Uniliner (with wool) – Packed with fused silica wool, highly recommended for high molecular weight active samples. The fused silica wool traps dirt and sample residue | 4 | 6.2 | 92.1 | 5 | N6502016 |
|  | NEW! Cyclo Uniliner – Cylindrical design for high molecular weight samples provides an excellent vaporization surface. Spiral traps dirt reducing further residue sample interaction | 4 | 6.2 | 92.1 | 5 | N6502017 |
|  | Wide-Bore Column Glass Liner | 6 | 4 | 92.1 | 1 | N6101375 |
|  | Wide-Bore Column On/Off Quartz Liner | 6 | 4 | 92.1 | 1 | N6121003 |

Colored Injector Liners

| | Description | ID mm | OD mm | Length mm | Pkg | Part No. |
|---|---|-------|-------|-----------|-----|-----------------|
|  | PSS deactivated glass liners with deactivated wool. Narrow bore and quartz wool increase volatilization and reproducibility | 2 | 4 | 86.2 | 5 | N9306232 |
|  | Capillary splitless deactivated glass liners with deactivated wool | 4 | 6.2 | 92.1 | 5 | N9306233 |
|  | Capillary splitless deactivated glass liners with deactivated wool | 4 | 6.2 | 92.1 | 1 | N9306234 |
|  | Capillary splitless deactivated glass liners with deactivated wool | 4 | 6.2 | 92.1 | 5 | N9306235 |
|  | Capillary splitless deactivated glass liners with deactivated wool. Quartz wool is used to fully vaporize the sample | 4 | 6.2 | 92.1 | 5 | N9306236 |
|  | PSS Splitless deactivated glass liners with deactivated wool 5/pk | 1.25 | 4 | 86.2 | 5 | N9306237 |

AUTOSAMPLER AND MANUAL SYRINGES



New Blue Barrel color design for enhanced sample volume verification (packs of 5 and 10 syringes)

Autosampler Syringes

Syringes from PerkinElmer are individually inspected for accuracy and performance.

Recommended autosampler syringes are available in 0.5, 5 and 50 µL capacities. For routine analyses, the metal plunger in barrel with PTFE-tipped seal is the standard syringe as shipped with each Clarus® GC instrument. Alternative syringes to use are the metal plunger in barrel or the 0.53 mm on-column injection.

| Description | Part No. |
|---|-----------------|
| 50 µL Syringe, Metal Plunger 0.63 mm o.d. Needle | N6101760 |
| 5 µL Syringe, Metal Plunger PTFE-tipped Seal 0.63 mm o.d. Needle | N6101390 |
| 5 µL Syringe, Metal Plunger PTFE-tipped Seal 0.63 mm o.d. Needle BLUE Barrel (pack of 5 syringes) | N6103240 |
| 5 µL Syringe, Metal Plunger PTFE-tipped Seal 0.63 mm o.d. Needle BLUE Barrel (pack of 10 syringes) | N6103241 |
| 5 µL Syringe, Metal Plunger 0.63 mm o.d. Needle | N6101251 |
| 5 µL On-column Syringe Metal Plunger 0.47 mm o.d. Needle | N6101380 |
| 0.5 µL Low Injection Volume Syringe, Metal Plunger 0.63 mm o.d. Needle | N6101252 |
| 0.5 µL Low Injection Volume Syringe Metal Plunger 0.63 mm o.d. Needle BLUE Barrel (pack of 5 syringes) | N6103242 |
| 0.5 µL Low Injection Volume Syringe Metal Plunger 0.63 mm o.d. Needle BLUE Barrel (pack of 10 syringes) | N6103243 |
| 0.5 µL Low Injection Volume Syringe, Metal Plunger 0.47 mm o.d. Needle | N6101253 |

Needles and Syringe Kits

Needle has a 90° bevel. Point style is recommended when the syringe is used for accurate pipetting of liquids. Excellent for mixing standards of very small volume.

Needles

| Description | Part No. |
|---|-----------------|
| Sample Needle w/Fittings | N2936009 |
| Air Guide Needle (62 mm) | N2936000 |
| Bio Compatible Sample Needle w/Tubing Connector | N2936010 |
| Needle (80 mm) | N2936342 |
| Low volume needles | N2931199 |

Syringe Kits

| Dimension | Buffer Tubing | Part No. |
|-----------|---------------|-----------------|
| 100 µL | 200 µL | N2936051 |
| 250 µL | 500 µL | N2936052 |
| 500 µL | 1,000 µL | N2936053 |
| 1,000 µL | 2,000 µL | N2936054 |
| 2,500 µL | 2,000 µL | N2936055 |

Point Style 2



This is a general purpose point style designed for septum penetration in all chromatographic techniques. The needle has a 22° bevel to minimize coring and needle plugging.

Point Style 3



Needle has a 90° bevel. Point style is recommended when the syringe is used for accurate pipetting of liquids. Excellent for mixing standards of very small volume.

GC Injector Syringes

Features and Benefits

- All PerkinElmer injectors have been tested and optimized for use with a 7 cm needle
- A 7 cm needle is critical to be sure your sample is deposited in the optimal zone

| Syringe Capacity | Gauge | Length | Pack Size | Point Style | Part No. |
|------------------|-------|--------|-----------|-------------|----------|
|------------------|-------|--------|-----------|-------------|----------|

Removable Needle Syringes (RN)

| | | | | | |
|--------|--|--|---|----|-----------------|
| 10 µL | | | 1 | #2 | N9302210 |
| 25 µL | | | 1 | #2 | N9302211 |
| 50 µL | | | 1 | #2 | N9302212 |
| 100 µL | | | 1 | #2 | N9302213 |

Replacement Needles for RN Syringes

| | | | | | |
|--------------|-----|------|---|----|-----------------|
| 10 µL | | | 1 | #2 | N9302222 |
| 25/50/100 µL | 22S | 2 in | 3 | #2 | N9302224 |
| 250 µL | 22S | 2 in | 3 | #2 | N9302226 |

Fixed Needle Syringes

| | | | | | |
|--------------------|--|--|---|----|-----------------|
| 10 µL ³ | | | 1 | #2 | 00230523 |
| 10 µL ² | | | 6 | #2 | N9302230 |
| 25 µL | | | 1 | #2 | N9302202 |
| 25 µL | | | 1 | #3 | 09904823 |
| 50 µL | | | 1 | #2 | N9302203 |
| 50 µL | | | 1 | #3 | 09904941 |

² Savings based on one-piece price. Savings of 20% reflected in price shown.

³ Standard fitted with 7 cm needle.

11 MM MOLDED GREEN AND ORANGE INJECTION PORT SEPTA



Microsyringes (For Manual Injection)

Syringes are used for accurate and precise liquid delivery. Each syringe is hand-fitted to assure maximum accuracy. Our syringes are composed of glass barrels and precision stainless steel needles. The needle features a blunt tip, required for use with a Rheodyne injector.

| Description | Part No. |
|--|----------|
| 10 µL Syringe | 09904937 |
| 25 µL Syringe | 09904823 |
| 50 µL Syringe | 09904941 |
| 100 µL Syringe | 09904822 |
| Rheodyne 22-gauge Blunt Needle with Luer Hub | 09904943 |

Merlin MicroSeal™ Septum

The Merlin MicroSeal™ septa is a unique replacement septa employing a two-step sealing system and an advanced elastomer material.



Because the syringe needle does not pierce the septa, there is no debris and ghost peaks are greatly reduced. The MicroSeal™ septa also reduces the incidence of bent syringe needles and liner contamination. Usable in either manual or autosampler applications, this septa can improve your productivity and run reliability. Designed to be used with 23 gauge straight needle syringes. Pressure ranges from 4 to 100 psi and injection port temperatures up to 325 °C.

| Description | Part No. |
|--|----------|
| Merlin MicroSeal™ Septum Kit Includes: Injector Port Adapter, 2 Septa and 1 Nut | N9303344 |
| Merlin MicroSeal™ Septum | N9303345 |

Injector Septa

- PerkinElmer Green Injection septum, extremely low bleed over a wide range of inlet temperatures — 100 °C to 350 °C. Easier needle penetration and high puncture tolerance make this septum ideal for autosamplers. This septum is already conditioned and ready to use
- BTO™ (Bleed Temperature Optimized) injector septa, 11 mm diameter. Maximum recommended operating temperature 300 °C
- PTFE/Silicone injector septa, 11 mm diameter

| Description | Pkg. | Part No. |
|------------------------------------|------|----------|
| PerkinElmer Green Injection Septum | 50 | N6621028 |
| Low Bleed Injector Septa | 25 | N9303343 |
| PTFE/Silicone Injector Septa | 50 | 00090652 |
| Green Injection Port Septa | 10 | N9306218 |
| Green Injection Port Septa | 50 | N9306219 |
| Orange Injection Port Septa | 50 | N9302972 |

Green — Septa rated to 400 °C. The advanced green septum was created to combine significantly longer injection life, low bleed and low injection port adhesion. The result is a general use green septum made of uniquely formulated silicone rubber you can use for all your daily analyses. Packaged in a pre-cleaned glass screw top jar for high purity.

Orange — Septa rated to 400 °C. Uniquely formulated silicone rubber septa BTO® is bleed and temperature optimized for today's most demanding GC and GC/MS applications. Septa BTO® is formulated to extend low-bleed and outstanding mechanical properties of premium GC septa. It retains remarkable softness at high temperatures and has been optimized to reduce injection port adhesion. Packaged in a pre-cleaned glass screw top jar for high purity.

Add-On Kits

Auto-Ignite FID with PPC Add-On Kit

Kit includes: detector assembly with heater and sensor, heater block, igniter, programmable pneumatics, and controls for detector combustion gases. Requires, but does not include, amplifier (N6120162) and AutoSystem XL firmware revision 3.3 or higher. The AutoSystem XL must be PPC ready. If not, a PPC upgrade kit (N6120146) is required.

Note: AutoSystem XL GCs shipped prior to January 1997 require a new detector cover. Installation by PerkinElmer Service is required, but not included.

| Voltage | Part No. |
|---------|----------|
| 120 V | N6120167 |
| 240 V | N6120168 |

Auto-Ignite FID Add-On Kit (Manual Pneumatics)

Kit includes: detector assembly with heater and sensor, heater block, igniter, hydrogen pressure regulator, and needle valve. Requires, but does not include, amplifier (N6120162). Requires AutoSystem XL to have firmware revision 3.3 or higher.

Note: AutoSystem XL GCs shipped prior to January 1997 require a new detector cover (N6103151).

| Voltage | Part No. |
|------------------|----------|
| 120 V AutoSystem | N6120165 |
| 240 V AutoSystem | N6120166 |
| 120 V Clarus | N6520018 |
| 230 V Clarus | N6520019 |

FID Amplifier

Required for use with FID Detector Add-On Kit.

| Dimension | Part No. |
|---------------|----------|
| FID Amplifier | N6120162 |

Auto-Ignite FID Replacement Parts

| Description | Part No. |
|-------------------------------------|----------|
| 1 Collector Head Assembly | N6100357 |
| Silicone Rubber O-Ring* (not shown) | 09902143 |
| 2 Polarizer Nozzle | N6103167 |
| 3 Nozzle Insulator | 09907827 |
| 4 Nozzle Collector | N6101085 |
| 5 Body Assembly | N6103175 |
| 6 FID Jet Contact/Spring | N6001204 |
| 7 Jet Assembly | N6100361 |
| 8 FID Body | N6100364 |
| 9 Nozzle Assembly | N6100430 |

Detector Series Operation Kit

TCD/FID Series Operation Kit

Used to direct sample effluent from the TCD to the FID.

| Dimension | Part No. |
|------------------------------|----------|
| TCD/FID Series Operation Kit | N6120006 |

PID/FID Series Operation Kit

Used to direct sample effluent from the PID to the FID.

| Dimension | Part No. |
|------------------------------|----------|
| PID/FID Series Operation Kit | N6120059 |

FID Miscellaneous Accessories

| Description | Part No. |
|---|----------|
| Auto-Ignite Nozzle Replacement Tool For removing nozzle from auto-ignite FID body | N6103188 |
| Auto-Ignite FID Catalytic Reactor Accessory | N6120161 |
| Capillary Column Adapter For capillary column use with the FID 1/8 to 1/16 in. detector adapter | N6120020 |
| Ceramic Column Cutter | N9301376 |
| Cotton Applicators | N9301272 |
| Detector Cover (Brown Color) | N6103225 |
| Detector Cover (White Color) | N6103151 |
| Eraser Brush-Pencil | 09923078 |
| Jet Assembly | N6100194 |
| Jet Replacement Tool 1/4 in. nut driver for removing jet from auto-ignite FID body | N6101297 |
| Quartz Wool | N6102354 |
| Replacement Stainless Steel Glow Plug for Auto-ignite FID | N6103089 |
| Septa, low bleed (pkg. 50) | N9302972 |
| 1/4 in. Packed Column Adapter For use with 1/4 in. packed columns. 1/8 to 1/4 in. adapter fits both injector and detector ends | 00080100 |

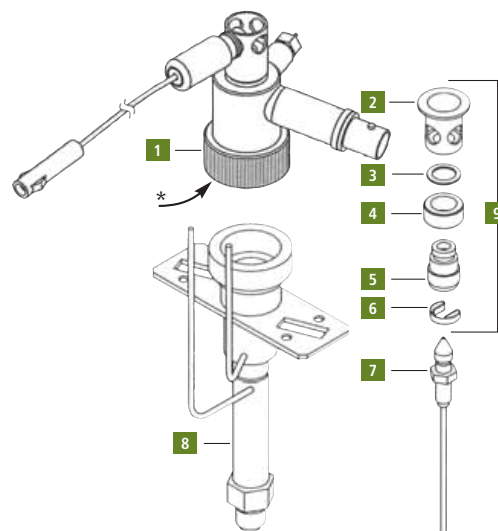

Catalytic Reactor Accessory

Auto-Ignite FID with PPC Add-On Kit

The catalytic reactor converts CO and CO₂ to methane conveniently and efficiently. The lower detection limit is extended to well below 0.1 ppm.

The catalytic reactor consists of a special catalytic reactor base which replaces the FID base. The reactor body contains a quantity of catalyst held in place by a quartz wool plug.

Kits include base assembly, reactor tube, and instructions.

External Igniter FID Catalytic Reactor Accessory

| Description | Part No. |
|--|-----------------|
| External Igniter FID Catalytic Reactor Accessory | N6120070 |

Auto-Ignite FID Catalytic Reactor Accessory

| Description | Part No. |
|---|-----------------|
| Auto-Ignite FID Catalytic Reactor Accessory | N6120161 |

Catalytic Reactor Replacement Parts

| Description | Part No. |
|--------------|-----------------|
| Catalyst | N9302698 |
| Jet Assembly | N6100194 |
| Quartz Wool* | N6102354 |

* Product available in the USA only

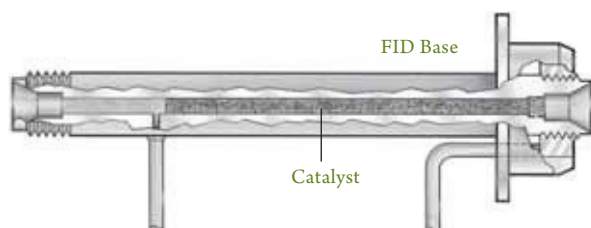

Miscellaneous Accessories

External Ignite Nozzle Replacement Tool

For removing nozzle from External Ignite FID body.

| Description | Part No. |
|---|-----------------|
| External Ignite Nozzle Replacement Tool | N6100102 |

Hydrogen Regulator Replacement Kit

| Description | Part No. |
|------------------------------------|-----------------|
| Hydrogen Regulator Replacement Kit | N6100289 |

Hydrogen/Air Replacement Needle Valve

| Description | Part No. |
|---------------------------------------|-----------------|
| Hydrogen/Air Replacement Needle Valve | N6101412 |

Igniter Assembly

Complete replacement igniter assembly with glow plug.

| Description | Part No. |
|------------------|-----------------|
| Igniter Assembly | N6100016 |

Replacement Glow Plug for External Ignite FID

| Description | Part No. |
|---|-----------------|
| Replacement Glow Plug for External Ignite FID | 00091279 |

FID Flow Measurement Adapter

| Description | Part No. |
|------------------------------|-----------------|
| FID Flow Measurement Adapter | N6101345 |

DETECTORS - FLAME PHOTOMETRIC DETECTOR (FPD)

Add-On Kits

The FPD is a highly sensitive and selective detector for both sulfur and phosphorus compounds. It is especially suitable for environmental monitoring of H₂S and sulfur gases in general and for organophosphorus compounds present at trace levels in pesticide analysis. Alkyl tin compounds can also be analyzed by changing the filter assembly. The sulfur filter is shipped standard.

The FPD mounts in either the front or rear detector position. This allows many detector combinations, such as FPD/FPD, FPD/TCD, and FPD/ELCD.

The AutoSystem also includes a linearizer function for the sulfur mode and convenient control of the photomultiplier tube from the keyboard.

The FPD is capillary-column compatible. The detector will accept columns of 0.530 mm i.d. or less. The standard jet shipped with the FPD does not have a glass-lined tail pipe. If an all-glass system is required and glass packed columns will be used, then a glass-lined tail pipe should be ordered (N6100264). As a reminder, use of packed 1/4 in. columns requires a 1/8 to 1/4 in. adapter.

Filters

| Description | Part No. |
|--------------------------|----------|
| Phosphorus Lens (Yellow) | N6000981 |
| Sulfur Lens* (Blue) | N6000637 |
| Tin Lens (Orange) | L4135472 |

* Shipped standard.

FPD Add-On Kit (Manual Pneumatics)

Kit includes detector, heater, sensor, heater block, hydrogen needle valve, air pressure regulator, and sulfur photomultiplier filter. Requires but does not include FPD amplifier (N6120095). Firmware revision 1.6 or greater required. Firmware must be PerkinElmer Service installed. AutoSystem operator's manual (09938559) revision E or higher required.

| Voltage | Part No. |
|------------------|----------|
| 120 V AutoSystem | N6120088 |
| 240 V AutoSystem | N6120089 |
| 120 V Clarus | N6520028 |
| 230 V Clarus | N6520029 |

FPD Amplifier

Firmware revision 1.6 or greater required. Firmware must be PerkinElmer Service installed. AutoSystem operator's manual (09938559) revision E or higher required.

| Description | Part No. |
|---------------|----------|
| FPD Amplifier | N6120095 |

FPD Replacement Parts for AutoSystem Series GCs

| Description | Part No. |
|---|----------------------|
| 1 O-Ring | 09902247 |
| 2 Seal Assembly and Window (heat shield) | N9300096 |
| 3 Liner (window) | N6003057 |
| 4 FPD Body (upper) | N6100243 |
| 5 Window Holder | N6003066 |
| 6 FPD Jet, Glass-lined Jet Tailpipe (for all-glass system) | N6100245 N6100264 |
| 7 FPD Body (lower) | N6100244 |
| 8 Photomultiplier Tube | 09972321 |

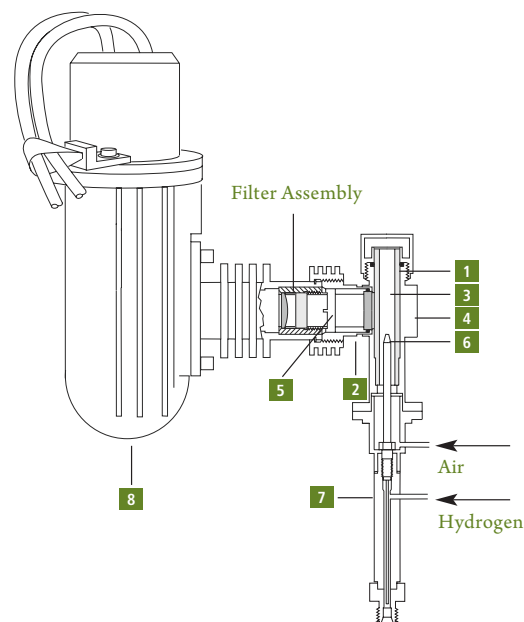

FPD with PPC Add-On Kit

Kit includes: detector, heater, sensor, heater block, programmable pneumatic control for detector combustion gases, and sulfur photomultiplier filter. Requires, but does not include, FPD amplifier (N6120095). AutoSystem XL GC must be PPC ready. If not, a PPC upgrade kit (N6120146) is required. Installation by PerkinElmer Service is required, but not included.

| Voltage | Part No. |
|---------|----------|
| 120 V | N6120128 |
| 230 V | N6120129 |

Packed Column Adapter

1/8 to 1/4 in. adapter for use with 1/4 in. packed columns.

| Description | Part No. |
|--------------------|----------|
| Adapter (set of 2) | 00080100 |

Add-On Kit

The ECD is a versatile, nondestructive detector which responds strongly to halogen-containing compounds as well as to certain other electron-capturing substances. The ECD's high sensitivity and selectivity make it an ideal choice for pesticide-residue analysis and for detection of halogen-derivatized compounds.

The ECD has an independent temperature range of 100 - 450 °C. The detector contains thermal protection that prevents heating the Ni63 source to temperatures beyond safe operating limits. Two ECDs can be installed and operated simultaneously on the AutoSystem Series and Clarus GCs. Nitrogen or argon/methane is the required detector operating gas. The base of the detector terminates in a 1/8 in. fitting.

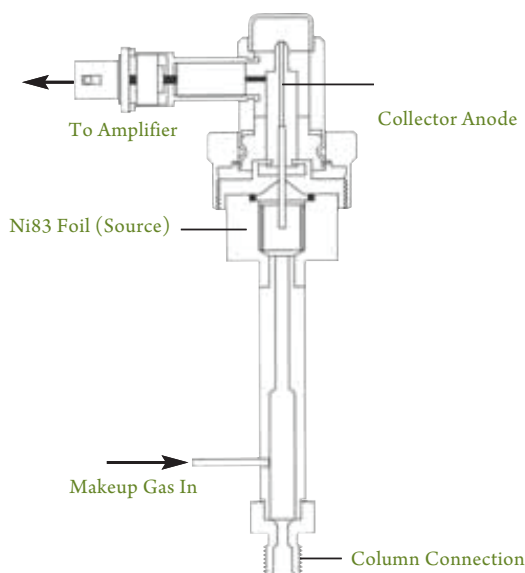

ECD Add-On Kit (Manual Pneumatics)

Kit includes all parts necessary to install an ECD on the AutoSystem Series or Clarus GCs. Includes: detector, heater, sensor, heater block, 1/16 in. makeup gas line, makeup gas needle valve, and vent tube assembly. Requires, but does not include, ECD amplifier (N6120014). Installation by PerkinElmer Service is recommended.

| Voltage | Part No. |
|------------------|----------|
| 120 V AutoSystem | N6120011 |
| 240 V AutoSystem | N6120026 |
| 120 V Clarus | N6520020 |
| 230 V Clarus | N6520021 |

ECD Amplifier

Required for use with ECD detector with add-on kit.

| Description | Part No. |
|---------------|----------|
| ECD Amplifier | N6120014 |

ECD Add-On Kit (PPC Pneumatics)

Kit includes: detector, heater, sensor, heater block, and programmable pneumatic control for makeup gas. Requires, but does not include, ECD amplifier (N6120014). The AutoSystem XL or Clarus GCs must be PPC ready. If not, a PPC upgrade kit (N6120146) is required. Installation by PerkinElmer Service is required, but not included.

| Voltage | Part No. |
|---------|----------|
| 120 V | N6120122 |
| 230 V | N6120123 |

Vent Tube Assembly

Flexible tube to safely vent toxic sample effluent.

| Description | Part No. |
|--------------------|----------|
| Vent Tube Assembly | N6100161 |

Column Adapters

Capillary Column Adapter/Receiver

Adapter converts 1/8 in. fitting to 1/16 in. for use with capillary columns.

Note: Glass-lined tubing reduces background from polyimide coating in high-temperature applications.

| Description | Part No. |
|-----------------------------------|----------|
| Capillary Column Adapter/Receiver | N6000986 |

PID/ECD Series Operation Kit

Kit for directing effluent from PID to ECD.

| Description | Part No. |
|------------------------------|----------|
| PID/ECD Series Operation Kit | N6120059 |

1/4 in. Packed Column Adapter

For use with 1/4 in. packed columns. 1/8 to 1/4 in. adapters fit both injector and detector ends. (Pkg. 2)

| Description | Part No. |
|-------------------------------|----------|
| 1/4 in. Packed Column Adapter | 00080100 |

ECD Wipe Test Kit

U.S. Federal law requires that all ECDs be wipe-tested periodically as described in the instrument operator's manual. In the U.S., possession and use of ECD is regulated by N.R.C. and/or state regulatory agencies. Licensing by regulatory agencies is required. Outside of the U.S., check with governing bodies for licensing and regulations covering possession and use. This kit contains everything necessary to do a complete wipe test. For use on any model GC ECD.

| Description | Part No. |
|------------------------------|----------|
| PID/ECD Series Operation Kit | 00091667 |

DETECTORS - NITROGEN PHOSPHOROUS DETECTOR (NPD)

Add-On Kit

NPD Add-On Kit (Manual Pneumatics)

The NPD can be used for the analysis of organic compounds containing nitrogen or phosphorus down to the picogram level. The NPD has become the detector of choice for low-level drug and pesticide applications because of its sensitivity and selectivity.

Kit includes: detector, heater, sensor, heater block, air needle valve, and hydrogen pressure regulator with snubber and two beads. Requires, but does not include, amplifier. For AutoSystem GC Firmware revision 1.4 or greater is required. Firmware must be PerkinElmer Service installed.

| Voltage | Part No. |
|------------------|----------|
| 120 V AutoSystem | N6120090 |
| 240 V AutoSystem | N6120091 |
| 120 V Clarus | N6520024 |
| 230 V Clarus | N6520025 |

NPD Amplifier

Required for use with NPD Add-On Kit.

| Description | Part No. |
|---------------|----------|
| NPD Amplifier | N6120094 |

NPD with PPC Add-On Kit

Kit includes: detector, heater, sensor, heater block, and programmable pneumatic control for detector combustion gases and two beads. Requires, but does not include, amplifier (N6120094). The AutoSystem XL or Clarus GC must be PPC ready. If not, the PPC upgrade kit (N6120146) is required. Installation by PerkinElmer Service is required, but not included.

| Voltage | Part No. |
|---------|----------|
| 120 V | N6120126 |
| 240 V | N6120127 |

Column Adapter

1/4 in. Packed Column Adapter

1/8 to 1/4 in. detector receiver adapter for use with 1/4 in. packed columns. Two included (injector/detector).

| Description | Part No. |
|-------------------------------|----------|
| 1/4 in. Packed Column Adapter | 00080100 |

Replacement Parts

| | Description | Part No. |
|---|---------------------------------------|----------------------|
| 1 | Collector Head | N6100253 |
| 2 | Bead Assembly (pkg. 5) Single pkg. | N6120093 N6120092 |
| 3 | Jet Assembly | N6100038 |
| 4 | NPD Body | N6100228 |

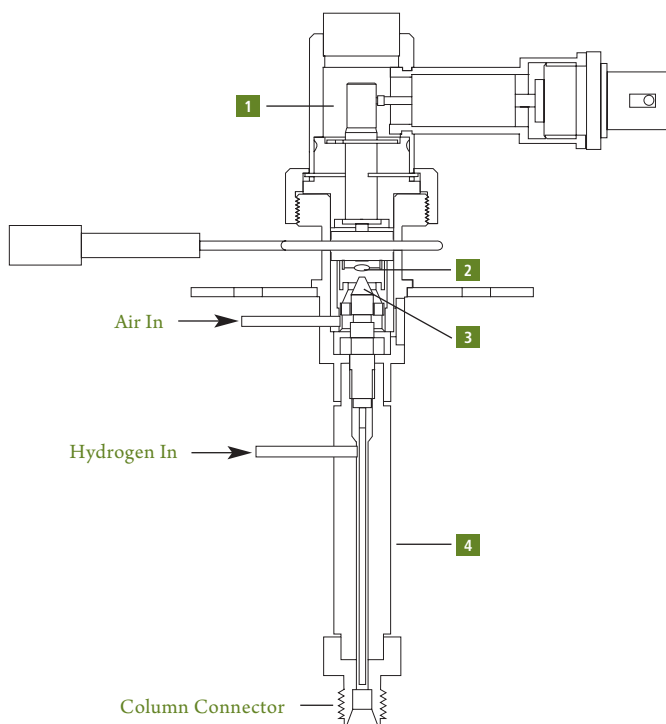

Add-On Kit

PID Add-On Kit (Manual Pneumatics)

The PID utilizes a high-intensity ultraviolet light source to ionize the sample components eluting from the column in order to generate the chromatographic signal. The PID has a maximum recommended operating temperature of 250 °C. The lamp can be replaced with a blanking disk to allow bake-out operation (up to 350 °C). Kit includes: detector, heater, sensor, makeup gas needle valve, and all necessary mounting hardware for installation on an AutoSystem GC. Requires, but does not include, amplifier (N6120061) and lamp power supply (N6120062). Firmware revision 1.2 or greater is required. Firmware must be PerkinElmer Service installed. AutoSystem operator's manual (09908559) is required if not revision F or higher.

| Voltage | Part No. |
|------------------|-----------------|
| 120 V AutoSystem | N6120047 |
| 240 V AutoSystem | N6120057 |
| 120 V Clarus | N6520026 |
| 230 V Clarus | N6520027 |

PID Amplifier

Required for use with PID Add-On Kit.

| Description | Part No. |
|---------------|-----------------|
| PID Amplifier | N6120061 |

PID Lamp Power Supply

Required for use with PID Add-On Kit.

| Description | Part No. |
|-----------------------|-----------------|
| PID Lamp Power Supply | N6120062 |

PID with PPC Add-On Kit

Kit includes: detector, heater, sensor, heater block, and programmable pneumatic control for makeup gas. Requires, but does not include, amplifier (N6120061) and power supply (N6120062). The GC must be PPC ready. If not, a PPC upgrade kit (N6120146) is required. Installation by PerkinElmer Service is required, but not included.

| Voltage | Part No. |
|---------|-----------------|
| 120 V | N6120130 |
| 230 V | N6120131 |

Detector Series Operation Kits

| Description | Part No. |
|--|-----------------|
| PID/FID, PID/ECD Series kit for directing effluent from a PID to an FID or an ECD | N6120059 |

Miscellaneous Accessories

| Description | Part No. |
|---------------------------|-----------------|
| Bakeout Disk | 03302989 |
| Lamp Cleaning Compound | 03302775 |
| 1/4 in. Detector Receiver | 03300866 |
| 1/8 in. Detector Receiver | 03300865 |

Replacement Parts

| Description | Part No. |
|---|------------------------------------|
| 1 PID Lamp (10.2eV), For most applications including aromatics, alkenes, and aliphatics higher than C4. Shipped standard with PID PID Lamp (9.5eV), Improved selectivity for multiple ring aromatic, sulfur compounds | 03303599 03303598 |
| 2 PID Lamp Window Seal | 03302778 |
| 3 PID Lower Lamp Seal | 03302777 |
| 4 Shoulder Pin | 03302976 |
| 5 Cap Nut | 03303773 |
| 6 Base Assembly | 03302979 |
| 7 Spring | 03302973 |
| 8 Cap with Harness | N6101696 |

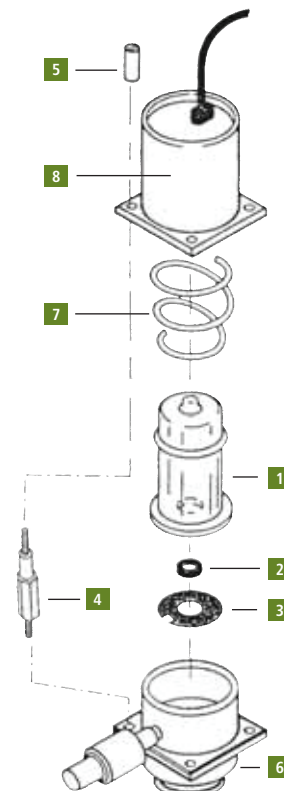

Add-On Kits

Features and Benefits:

- Lower Internal Volume and Smaller Overall Size
- No Makeup Gas Required with 0.53 mm and 0.32 mm i.d. Capillary Columns
- Series Connection Option
- Excellent Sensitivity Over a Wide Dynamic Range

TCD Add-On Kit (Manual Pneumatics)

Kit includes all necessary items to install the TCD into the instrument: detector, heater, sensor, heater block, 1/16 in. gas line, and flow controller pneumatics. Requires, but does not include, amplifier (N6120015). The TCD can only be installed in the rear detector position.

| Voltage | Part No. |
|------------------|----------|
| 120 V AutoSystem | N6120012 |
| 240 V AutoSystem | N6120027 |
| 120 V Clarus | N6520022 |
| 230 V Clarus | N6520023 |

TCD Amplifier

| Description | Part No. |
|---------------|----------|
| TCD Amplifier | N6120015 |

TCD with PPC Add-On Kit

Kit includes: detector, heater, sensor, heater block, and programmable pneumatic control for reference gas. Requires, but does not include, amplifier (N6120015). The TCD can only be installed in the rear detector position. The GC must be PPC ready. If not, a PPC upgrade kit (N6120146) is required. Installation by PerkinElmer Service is required, but not included.

| Voltage | Part No. |
|---------|----------|
| 120 V | N6120124 |
| 240 V | N6120125 |

TCD with PPC Makeup Gas Kit

Includes parts required to add PPC controlled makeup gas to an existing TCD. Includes tubing, tee-piece, PPC pneumatics module, and PPC frit #4 (N6120155). Requires PPC capability in the GC.

| Description | Part No. |
|-----------------------------|----------|
| TCD with PPC Makeup Gas Kit | N6120150 |

Column Adapter

| Description | Part No. |
|--|----------|
| 1/8 to 1/4 in. Column adapter for use with 1/4 in. packed columns | 00080100 |
| 1/8 to 1/16 in. Column adapter for use with capillary columns | N6120020 |

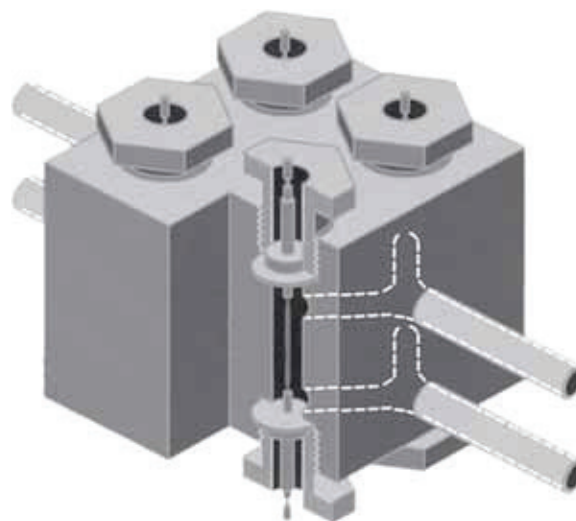

Thermal Conductivity Detector

TCD/FID Series Operation Kit

TCD and FID series operation kit for directing effluent from a TCD to an FID.

| Description | Part No. |
|------------------------------|----------|
| TCD/FID Series Operation Kit | N6120006 |

TCD Detector Makeup Gas Kit (Manual Pneumatics)

For use with TCD (at low flow rates). Required when using 0.25 mm i.d. and recommended when using 0.32 mm i.d. capillary columns. Kit includes 1 m of 1/16 in. tubing to connect to gas supply, graphite/vespel ferrules, manual pneumatics, and installation instructions.

| Description | Part No. |
|---|----------|
| TCD Detector Makeup Gas Kit (Manual Pneumatics) | N6120080 |



The Marathon™ Filament is a revolutionary, patent-pending technology developed exclusively by PerkinElmer, delivering long life even under the most difficult chromatography conditions.

After lengthy performance testing and filament research, the new Marathon Filament has been engineered to provide exceptional long life and withstand difficult chromatography conditions.

It has high resistance to demanding injections such as Headspace or purge and trap and has stood up to challenging applications such as flame-retardant analysis.

The Marathon Filament is a direct replacement of the previous rhenium filament — no system changes required.

At PerkinElmer, we understand your challenges and are committed to providing the best solutions to make your life easier. The new Marathon Filament is part of our ongoing efforts to deliver the latest technology for our PerkinElmer GC/MS platform.

Features and Benefits

- Long life even under the most difficult chromatography conditions
- Unique white surface engineered for maximum durability and optimum performance
- Now included with all new Clarus® GC/MS systems (S80 and SQ8 series)
- Backward compatible with all units using rhenium filaments
- Works with both electron and chemical ionization sources

| Description | Part No. |
|---|-----------------|
| Marathon Filament for PerkinElmer GC/MS Systems | N6470012 |

To view the webcast and to order your replacement filament, visit:
www.perkinelmer.com/MarathonFilament

SIMPLE FLEXIBLE PRODUCTIVE

SMARTsource™ with Marathon Filament for Clarus® SQ 8 GC/MS Systems

Capable of both EI and CI ionization, the SMARTsource (Simplified Maintenance And Removal Technology) on the Clarus SQ 8 GC/MS has been designed for ultimate simplicity, flexibility and productivity. Switching sources can be done in a matter of seconds by simply twisting and pulling – no tools required, no wires to disconnect. Cleaning the source is equally as easy and can be performed by the user. So even if you're running tough matrices, you won't be slowed down by time-consuming expensive source cleanings and replacements.

Fewer Parts, Greater Ease.

With very few parts, the SMARTsource is exceptionally robust and easy to maintain. Each component is clearly marked for simple reassembly, and reconfiguring between EI and CI can even be performed in less than 3 minutes with a quick-conversion kit. Since the source is removed from the front of the Clarus SQ 8, the analyzing quadrupole is never exposed, minimizing the risk of contamination to ensure more reliable data.

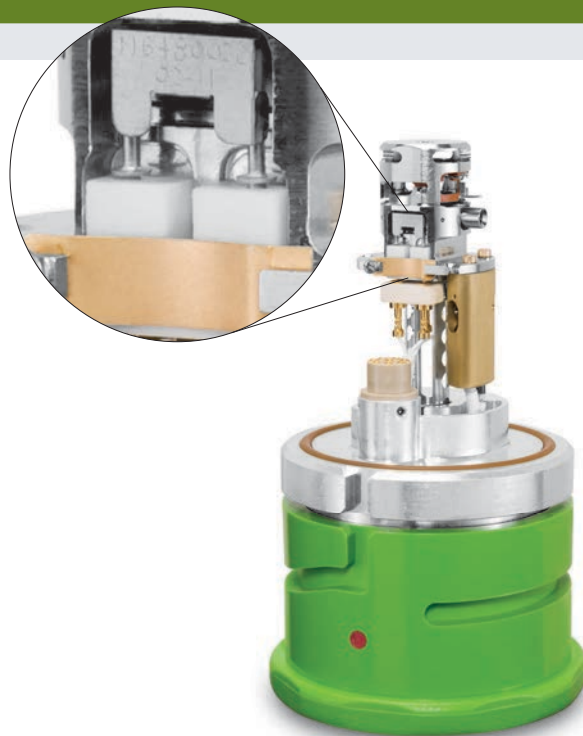

Features and Benefits:

- 12 parts make up EI source
- SMARTsource rebuilt in minutes
- Remove SMARTsource with the twist of a wrist
- Marathon filament has a long life even under the most difficult chromatography conditions and is engineered for maximum durability and optimum performance



Take the guesswork out of setting your column depth. Our Handle Assembly allows for precise alignment of the column within the SMARTsource every time.

Handle Assembly (Source Blank and Sight)

| Description | Part No. |
|--|----------|
| Handle Assembly (Source Blank and Sight) | N6480380 |
| Replacement Protective Cover | N6482024 |

SMARTsource Maintenance Kits

| Description | Part No. |
|---|----------|
| SQ8 Maintenance Kit Tool kit needed to maintain source | N6480360 |
| SQ8 Deluxe Polishing Kit (120 Volt) Kit for polishing cleanable source parts | N6480361 |
| SQ8 Deluxe Polishing Kit (240 Volt) | N6480362 |

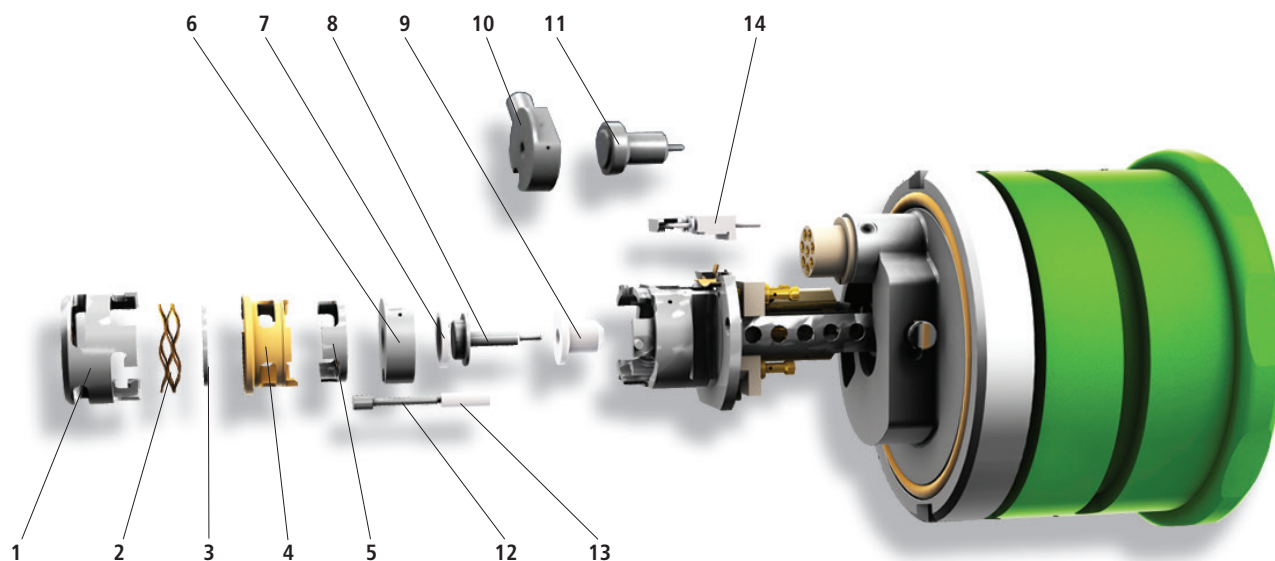

SMARTsource Replacement Parts

| Number | Description | Part No. |
|--------|------------------------|----------|
| 1 | Source Lens #3 | N6480149 |
| 2 | Source Spring | N6480151 |
| 3 | Source Lens #2 | N6480148 |
| 4 | Lens Insulator | N6480153 |
| 5 | Source Lens #1 | N6480147 |
| 6 | EI Ion Volume | N6480144 |
| 7 | Insulator (Ion Volume) | N6480145 |

| Number | Description | Part No. |
|--------|----------------------|----------|
| 8 | Repeller | N6480140 |
| 9 | Insulator (Repeller) | N6480141 |
| 10 | CI Ion Volume | N6480146 |
| 11 | CI Ion Volume Disc | N6480154 |
| 12 | Trap | N6480142 |
| 13 | Insulator (Trap) | N6480143 |
| 14 | Marathon Filament | N6470012 |

SMARTsource Kits

| Description | Part No. |
|---|----------|
| Complete CI Source Consists of a fully assembled CI Source, ready to install | N6480130 |
| Complete EI Source Consists of a fully assembled EI Source, ready to install | N6480132 |
| Insulator Replacement Kit (Numbers 2, 4, 7, 9, 13) | N6480080 |
| EI Optics Replacement Kit (Numbers 1, 3, 5, 6, 8, 12) | N6480081 |
| CI Optics Replacement Kit (Numbers 1, 3, 5, 8, 10, 12) | N6480082 |

PACKED TRAPS SPECIFICALLY DESIGNED FOR PERKINELMER THERMAL DESORBERS

Air Monitoring Trap

Low flow trap packed with carbonaceous sorbents suitable for ozone precursor and air toxin monitoring.

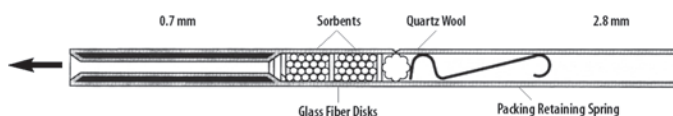

Low Flow Cold Trap

Cold Traps

TurboMatrix Thermal Desorption Trap Supplies

Trap supplies from PerkinElmer, the market leader in thermal desorption, will provide exceptional analytical performance. Used for U.S. EPA Method TO17, the PerkinElmer standard trap, packed with Tenax™, on the TurboMatrix™ Thermal Desorber, will improve productivity and trapping capacity. The TurboMatrix air monitoring trap is packed with carbonaceous sorbents suitable for ozone precursor and air toxics monitoring.

| Description | Qty. | Part No. |
|--|------|----------|
| Cold Traps for TurboMatrix | | |
| Air Monitoring Trap | 1 | M0413628 |
| Empty Trap | 1 | M0413627 |
| Tenax™ TA 60/80 Packed Trap | 1 | M0413535 |
| Carbopack® C Packed Trap | 1 | N6200150 |
| Cold Traps for ATD 400 | | |
| Air Monitoring Trap | 1 | L4275108 |
| Trap Nuts (2 required) | 1 | L4275009 |
| Trap Tube Low Flow, Empty (Narrow-bore at one end. Allows minimum gas flow during trap desorption) | 1 | L4275107 |
| Tenax™ TA 60/80 Packed Trap | 1 | L4275089 |
| Empty Trap | 1 | L4271106 |



Cold Traps Fittings and Accessories

| Description | Qty. | Part No. |
|---|------|----------|
| Graphite Ferrule | 2 | L4271187 |
| SilTite™ Ferrule (GC/MS) 0.4 mm | 10 | N9306093 |
| SilTite™ Ferrule (GC/MS) 0.5 mm | 10 | N9306094 |
| SilTite™ Ferrule (GC/MS) 0.8 mm | 10 | N9306095 |
| SilTite™ Nuts | 5 | N9306096 |
| PTFE Ferrule | 10 | L4275110 |
| Graphite/Vespel® Ferrule for ATD 400 | 5 | L1003027 |
| Valco® Graphite/Vespel® Ferrule for ATD 400 | 5 | L1003028 |
| Trap Filter Disk | | L1003030 |
| Trap Packing Disk | 20 | L4271290 |
| Trap Packing Retaining Spring | 5 | N6301054 |
| Quartz Wool (Untreated) 5 g | | N6102354 |
| Cold Trap Packing Tool | | L4271203 |
| Cold Trap Removal Tool | | L4271205 |
| Regulator 0–60 psig | | N6101474 |
| Backflush Nozzle for ATD 400 | | L4275072 |
| Internal Standard Injection Accessory for ATD 400 | | L4270010 |
| Liquid Nitrogen Accessory for ATD 400 | | L4270009 |
| Gauze Loading Rig | | L4070023 |
| Replacement Plastic Plunger for Gauze Loading Rig | | L4071151 |



Thermal Desorber Starter Kit

PerkinElmer's convenient starter kit includes all products you need to run the TurboMatrix Thermal Desorber.

Features and Benefits

- All items available under one part number in a convenient kit
- Guaranteed PerkinElmer parts
- Improved chromatography with exceptional analytical performance using PerkinElmer parts

| Description | Part No. | | |
|---------------------------------------|-----------------|------|-----------------|
| Thermal Desorber Starter Kit | M0413541 | | |
| Contents | Pkg. | Qty. | Part No. |
| Glass Fiber Separator Disks | 20 | 1 | L4271290 |
| Glass Sample Tubes | 10 | 1 | M0413598 |
| Glass Wool | 1 | 1 | 54120790 |
| Graphite Ferrules | 2 | 1 | L4271187 |
| O-ring | 1 | 1 | L1003006 |
| O-ring, Viton | 1 | 1 | L1003008 |
| Packing Gauze | 100 | 1 | L4071034 |
| PTFE Filter Discs | 10 | 1 | L1003030 |
| PTFE Filter Discs - Large | 10 | 1 | L1003029 |
| Retaining Spring | 50 | 1 | L4071123 |
| Sample Tube - 5 mL | 1 | 1 | 04970673 |
| Stainless Steel Retaining Spring | 2 | 1 | L6301054 |
| Stainless Steel Sample Tubes - Capped | 10 | 1 | M0413595 |
| Tenax TA 60/80, Mesh - 15 g | 1 | 1 | 04978064 |
| Trap Tube Nuts | 2 | 1 | L4275009 |
| Trap Tubes | 2 | 1 | M0410094 |

Thermal Desorber Industrial Hygiene Application Kit

All your consumable needs in one convenient kit, designed specifically for Industrial Hygiene using Thermal Desorption*.

| Description | Part No. | | |
|---|-----------------|------|-----------------|
| Workplace Air Monitoring Industrial Hygiene Application Kit** | N6710188 | | |
| Contents | Pkg. | Qty. | Part No. |
| Cold Trap O-ring, 0.145 i.d./0.070 w.d. | 1 | 1 | 09200091 |
| Cold Trap Tube (Tenax TA) | 1 | 1 | L4275089 |
| Empty Glass Sample Tubes - No Caps | 10 | 1 | L4071594 |
| Graphite Ferrule | 2 | 1 | L4271187 |
| Pen Clips for Stainless Steel Sample Tubes | 10 | 1 | L4071029 |
| PTFE Ferrule | 10 | 1 | L4275110 |
| PTFE Filter Disk - Either Side of the Cold Trap | 10 | 1 | L1003030 |
| Tenax TA Stainless Steel Sample Tubes | 10 | 1 | N9307005 |

* For full downloadable pdf format application notes, please visit: <http://las.perkinelmer.com/applications>

** Applicable to TurboMatrix 100/150/300/350 and 650 only

Thermal Desorber Caps and Accessories

| Description | Pkg. | Part No. |
|--|------|-----------------|
| Brass Long-Term Storage Caps Recommended for long-term storage, two required per tube. Also requires PTFE Ferrule (L1003015). | 1 | 09908851 |
| Combined PTFE Ferrule For use with ¼ in Brass Long-Term Storage Caps (09908851), two required per tube. | 5 | L1003015 |
| Diffusion Caps - Standard For passive air sampling, to ensure correct diffusion path length. | 10 | L4070207 |
| Diffusion Caps with Membrane As above, 10 with silicone membrane inserted | 10 | L4070208 |
| Pen Clips For Stainless Steel Thermal Desorber Tubes. | 10 | L4071029 |
| PFA PTFE Ferrules For TurboMatrix Storage End Caps. | 20 | M0413625 |
| TurboMatrix Analytical Caps PTFE Caps with O-ring, Required for Use on the TurboMatrix Instrument During Analysis | 20 | N6200119 |

CONDITION TUBES FASTER AND EASIER

PerkinElmer's New ATD tube conditioning oven now conditions tubes faster and easier than ever before. ATD tubes must be re-conditioned after analysis to remove contaminants before they are used for sampling. You can do this one of two ways. You can condition each tube individually on your thermal desorption instrument. This takes time – especially if you have several tubes to condition – and also ties up your instrument which could be used for more important analysis. Or, a better more efficient alternative is to condition your tubes in a separate oven.

PerkinElmer ATD Tube Conditioning Oven:

- Condition any number or combination of stainless steel and glass tubes simultaneously without wasting gas
- Hood interlock protects anyone in the lab from opening the oven until it's cool
- Dual automatic fan design cools the oven in minutes
- Oven vent through the top hood ensuring a contaminant free oven

| Description | Part No. |
|---------------------------|----------|
| TurboMatrix TC 220 (120V) | N9309160 |
| TurboMatrix TC 220 (230V) | N9309161 |



Specifications

| Description | |
|-------------------|----------------------|
| Capacity | Holds up to 20 tubes |
| Temperature Range | Ambient – 400 °C |
| Programming | 4 Ramps + 4 Soaks |
| Flow Rate | 25 – 150 mL/min |



Unconditioned Thermal Desorber Tubes



Fully conditioned Thermal Desorber tubes shown



SVI™ Soil Vapor Intrusion™ Tubes

Soil vapor intrusion occurs when toxic compounds that are present in the air space in soil of a contaminated location have ways of entering a building, potentially creating a health risk. Our new multi-bed construction extends the hydrocarbon range past naphthalene while retaining the lighter components, enabling larger sample volumes, hence, enhancing detection limits. Has a unique design that meets the challenges and criteria of the EPA regulations for air monitoring.

- From chloromethane through diesel range hydrocarbons
- After the analysis, tubes are clean and ready for re-sampling reducing costs

Empty Sample Tubes with Plastic End Caps

| Description | Part No. |
|---------------------------------------|-----------------|
| Stainless Steel (pkg. 10) | M0413595 |
| Glass Lined Stainless Steel (pkg. 10) | M0413597 |
| Glass (pkg. 10) | M0413598 |

Unconditioned Thermal Desorber Tubes

For your convenience, new low-cost thermal desorber tubes are offered in both stainless steel and glass. Each tube maintains its unique serial number which is etched for easy identification. Tubes are offered with a variety of sorbent packing materials for many GC applications including indoor and outdoor air monitoring, analysis of flavors and fragrances and the analysis of outgassing from packaging, polymers, pharmaceuticals and semi-conductor material. These tubes are unconditioned and ship with plastic end caps for short-term storage.

Packed Unconditioned Sample Tubes, Plastic End Caps (pkg. 10)

| Sorbent | Stainless Steel Part No. | Glass Part No. |
|------------------------|--------------------------|-----------------|
| Air Toxics | N9307050 | N9307058 |
| Carbopack™ B60/80 | N9307051 | N9307059 |
| Carbosieve™ SIII 60/80 | N9307052 | N9307060 |
| Tenax™ GR 60/80 | N9307053 | N9307061 |
| Tenax™ TA 60/80 | N9307054 | N9307062 |
| Chromasorb™ 60/80 | N9307055 | N9307063 |
| Carbopack™ B 60/80 | N9307056 | N9307064 |
| Carbopack™ C 60/80 | | |
| Carbosieve™ SIII 60/80 | | |
| Carbotrap™ C/B | | N9307065 |
| NIOSH | N9307057 | N9307066 |

Empty Sample Tubes without Caps

| Description | Part No. |
|----------------------------|-----------------|
| Stainless Steel (pkg. 10) | L4270128 |
| Glass (pkg. 10) | L4071594 |
| Stainless Steel (pkg. 100) | L4270129 |

| Description | Part No. |
|---|-----------------|
| Stainless Steel TD Tubes Conditioned | N9306277 |
| Stainless Steel TD Tubes Un-Conditioned | N9306278 |

Conditioned Thermal Desorber Tubes

Stainless steel and glass sample tubes are available with a wide variety of packing materials from single to multi-bed. PerkinElmer Thermal Desorber tubes are printed with the packing material and an arrow, which points to the end of the tube where sample is drawn from, and also indicates the end that desorb vapors will exit.

Each tube is etched with a unique serial number for ease of traceability and adsorbent identification. Stainless steel tubes may also be fitted with clips that accept adhesive labels for identification. Packed tubes are shipped with long-term brass storage caps and all tubes are thermally conditioned and tested for background and backpressure.

Packed Conditioned Sample Tubes, Brass Long-Term Storage End Caps (pkg. 10)

"NOT for Analytical test applications", use N6200119 PTFE caps and O-rings. (pkg. 20)

| Sorbent | Stainless Steel Part No. | Glass Part No. |
|--------------------------------|--------------------------|-----------------|
| Air Toxics | N9307001 | N9307008 |
| Carbopack™ B60/80 | N9307002 | N9307009 |
| Carbosieve™ SIII 60/80 | N9307003 | N9307010 |
| Tenax™ GR 60/80 | N9307004 | N9307011 |
| NEW PKI Tenax™ TA 60/80 | N9309130 | |
| Tenax™ TA 60/80 | N9307005 | N9307012 |
| Chromasorb™ 60/80 | N9307006 | N9307013 |
| Carbopack™ B 60/80 | N9307000 | N9307007 |
| Carbopack™ C 60/80 | | |
| Carbosieve™ SIII 60/80 | | |
| Carbotrap™ C/B | N9307026 | |
| NIOSH 2549 | N9307038 | N9307037 |

TurboMatrix 40 Headspace Trap

Sample Head Assembly Replacement Parts

| Description | Part No. |
|---|----------|
| ① Platinum/Iridium Needle, Wide-bore | B0144169 |
| ① Platinum/Iridium Needle, Small-bore | B0500959 |
| ① Platinum/Iridium Needle, Jet | B0510364 |
| ① Silcosteel Needle, for Headspace Trap Only | N6700130 |
| ① Stainless Steel Needle, Wide-bore | B0131385 |
| ① Stainless Steel Needle, Small-bore | B0500987 |
| ① Stainless Steel Needle, Jet (Ships with Instrument) | B4000011 |
| ② Needle Seal Assembly (Without O-Rings) | B0500833 |
| ③ O-Ring for Needle Seal Assembly (pkg. 10) | B0198110 |
| ④ Vespel Ferrule 1/16 in. (pkg. 10) | 09920127 |
| ⑤ Male Nut 1/16 in. | N9302832 |
| ⑥ GLT Adapter Tube | B0503956 |
| ⑥ GLT Adapter Tube, Silcosteel | N6700113 |
| ⑦ Graphite/Vespel Ferrule 1/16 in. x 0.4 mm For use with 0.25 mm i.d. Transfer Line, pkg. 10 | 09920104 |
| ⑦ Graphite/Vespel Ferrule 1/16 in. x 0.5 mm For use with 0.32 mm i.d. Transfer Line, pkg. 10 | 09920105 |
| ⑧ Nut 1/16 in. Swagelok | N9300059 |
| ⑨ Fused-Silica Capillary Transfer Line: 0.25 mm i.d. x 5 m Length | N9301356 |
| ⑨ 0.32 mm i.d. x 5 m Length | N9301357 |

Headspace Sample Head Assembly Schematic

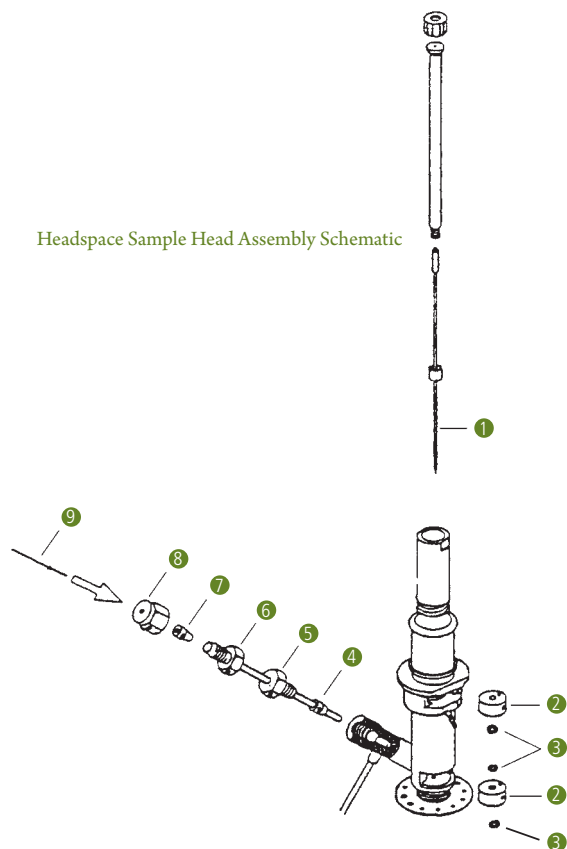

Solid Glass Blocking Trap

| Description | Part No. |
|---|----------|
| Block for Use in Standard Headspace Mode. | N6701170 |

Sample Trays

For use on the Mid-Range or High-Capacity headspace sampler.

| Description | Part No. |
|---|----------|
| TurboMatrix 40 Mid-Range Sample Tray | M0413592 |
| TurboMatrix 110 High-Capacity Sample Tray | M0413593 |

Transfer Lines

| Description | Tubing i.d. | Length | Part No. |
|---------------------------------|-------------|--------|----------|
| Siltek Deactivated Fused Silica | 0.25 mm | 5 m | N9316607 |
| Siltek Deactivated Fused Silica | 0.32 mm | 5 m | N9316608 |

Miscellaneous Accessories

| Description | Part No. |
|---|----------|
| Gas Chromatography — Theory and Practice, Static Headspace Book by L. Ettre and B. Kolb | N1011210 |

Cold Trap Options

Headspace Trap instruments only.

| Description | Part No. |
|--|----------|
| TurboMatrix HS Trap Cold Trap Tube (Carbopack C) | N6200150 |
| TurboMatrix HS Trap Air Monitoring Trap* | M0413628 |

* Trap comes standard with the instrument.

HIGH QUALITY GAS FILTRATION SYSTEMS

Features and Benefits:

- Two indicators – for oxygen and moisture
- Gas contacts only metal, fluoroelastomer and glass
- High capacity and efficiency in a single cartridge
- Easy cartridge replacement with on/off knob
- Double-seal construction for safety
- Check valves protect gas lines during cartridge replacement
- Includes mounting hardware for bench or wall

The Advanced Filter System has high-capacity and efficiency levels for oxygen, water and hydrocarbons. The recommended maximum flow rate is 2 L/min with 200 psi maximum operating pressure.

A polycarbonate shield surrounding the glass indicator section of the filter is sealed, unlike other gas filters, the gas flow is secure even if the glass should break. This redundant sealing system and robust construction provides a new level of security in gas filtration.



Advanced Filter System

| Description | Part No. |
|--|-----------------|
| Advanced Filter System | N9303963 |
| Replacement Cartridge for Oxygen, Water and Hydrocarbons | N9303964 |
| Manifold and Mounting Hardware | N9303139 |

| | Capacity | Efficiency |
|--------------|----------|------------|
| Oxygen | 850 cc | <1 ppb |
| Water | 12 g | <10 ppb |
| Hydrocarbons | 8 g | <1 ppb |

HIGH CAPACITY AND HIGH PURITY

Ultra Clean Gas Filters

Wrenches to change filters is a thing of the past. There is no longer a need for loosening and tightening fittings every time a trap is changed, which may contaminate your system during the process. Cartridge systems make changing gas filters quick and easy. A base plate allows cartridges to be exchanged without introducing ambient air. Spring-loaded check valves seal when a filter is removed and open only when a new filter has been locked in place.

Carrier Gas Purity

Carrier gas should contain less than 1ppm of oxygen, moisture, or other trace contaminants to prevent column degradation, increase column lifetime, and decrease stationary phase bleed. The expense of using high-purity gases in combination with carrier gas line purifiers will be offset by longer column lifetime and less GC maintenance.

Contaminants cause ghost peaks to appear during temperature programming and degrade the validity of analytical data. Make-up gas also should be contaminant-free, or baseline fluctuations and excessive detector noise can occur. Detector gases should be free of water and hydrocarbons, or excessive baseline noise can result. Gas purifiers remove these contaminants from gas sources, thereby improving system performance.

Base Plates

| | 1 Position | 2 Position | 3 Position |
|---|-----------------|-----------------|-----------------|
| Description | Part No. | Part No. | Part No. |
| Ultra Clean Base Plate - Brass 1/8" | N9306801 | N9306805 | N9306811 |
| Ultra Clean Base Plate - Brass 1/4" | N9306800 | N9306804 | N9306810 |
| Ultra Clean Base Plate - Stainless Steel 1/8" | N9306803 | N9306807 | N9306813 |
| Ultra Clean Base Plate - Stainless Steel 1/4" | N9306802 | N9306806 | N9306812 |

| | 2 Position Base Plate |
|---|-----------------------|
| Description | Part No. |
| Ultra Clean High Flow Base Plate - Brass 1/4" | N9306808 |
| Ultra Clean High Flow Base Plate - Stainless Steel 1/4" | N9306809 |

Kits - Base Plate and Cartridges

| | Triple Filter | Triple filter with He Conditioning | Triple filter with H2 Conditioning |
|--|-----------------|------------------------------------|------------------------------------|
| Base Plate Description | Part No. | Part No. | Part No. |
| Ultra Clean Base Plate - Brass 1/8" (1 Position) | N9306829 | N9306833 | N9306837 |
| Ultra Clean Base Plate - Brass 1/4" (1 Position) | N9306828 | N9306832 | N9306836 |
| Ultra Clean Base Plate - Stainless Steel 1/8" (1 Position) | N9306831 | N9306835 | N9306839 |
| Ultra Clean Base Plate - Stainless Steel 1/4" (1 Position) | N9306830 | N9306834 | N9306838 |

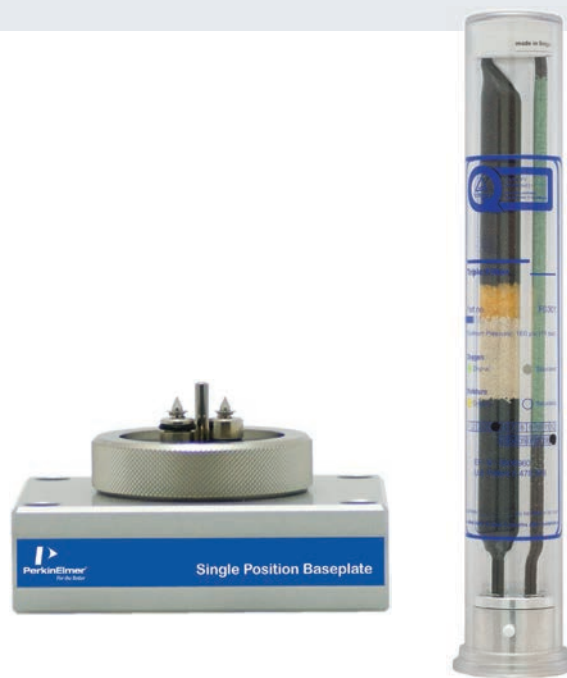

Features and Benefits:

- High purity output insures 99.9999% pure gas
- No tool replacement of filter cartridges, no need to shut gas flow off with quick disconnect base plate
- Easy to read indicators to determine replacement interval
- Helium and Hydrogen specific cartridges available: operational with 15 minute purge after installation
- Safety shielding of glass filter with plastic cover
- Serial numbered for ease of tracking

Kits - Base Plate and Cartridges (cont.)

| Base Plate Description | Hydrocarbon Filter (2/pack) Part No. |
|--|---|
| Ultra Clean High Flow Base Plate - Brass 1/4" (2 Position) | N9306840 |
| Ultra Clean High Flow Base Plate - Stainless Steel 1/4" (2 Position) | N9306841 |

| Base Plate Description | Triple Filter (1/pack), Combi Filter (2/pack) Part No. |
|--|--|
| Ultra Clean Base Plate - Brass 1/8" (3 Position) | N9306843 |
| Ultra Clean Base Plate - Brass 1/4" (3 Position) | N9306842 |
| Ultra Clean Base Plate - Stainless Steel 1/8" (3 Position) | N9306845 |
| Ultra Clean Base Plate - Stainless Steel 1/4" (3 Position) | N9306844 |

Cartridges - Replacements

| Description | Part No. |
|---|-----------------|
| Ultra Clean Moisture Filter | N9306814 |
| Ultra Clean Oxygen Filter | N9306815 |
| Ultra Clean Hydrocarbon Filter | N9306816 |
| Ultra Clean Hydrocarbon Filter with AT indicator | N9306817 |
| Ultra Clean Combi Filter (Moisture - Hydrocarbon) | N9306818 |
| Ultra Clean Triple Filter (Oxygen - Moisture - Hydrocarbon) | N9306819 |
| Ultra Clean Triple Filter (Oxygen - Moisture - Hydrocarbon) with AT indicator | N9306821 |
| Ultra Clean Triple Filter (Oxygen - Moisture - Hydrocarbon) conditioned with He | N9306820 |
| Ultra Clean Triple Filter (Oxygen - Moisture - Hydrocarbon) conditioned with H2 | N9306822 |

Cartridges - Bundles

| Description | Part No. |
|--|-----------------|
| Ultra Clean High Flow Moisture Filter Bundle (2 High Flow Moisture Filters) | N9306824 |
| Ultra Clean High Flow Hydrocarbon Filter Bundle (2 High Flow Hydrocarbon Filters) | N9306823 |
| Ultra Clean High Flow Hydrocarbon Filter Bundle (2 High Flow Hydrocarbon Filters) | N9306825 |
| Ultra Clean High Flow Hydrocarbon Filter Bundle (2 High Flow Hydrocarbon Filters) with AT indicators | N9306825 |
| Ultra Clean Filter Bundle of 3 (1 Triple Filter, 2 Combi Filters) | N9306826 |
| Ultra Clean Filter Bundle of 4 (1 Oxygen Filter, 1 Moisture Filter, 2 Hydrocarbon Filters) | N9306827 |

Connectors

| Description | Pkg. | Part No. |
|--|------|-----------------|
| Ultra Clean Connector Set - 1/4" Brass 3 Sets of two Connectors (in- and outlet) for Base plate | 6 | N9306846 |
| Ultra Clean Connector Set - 1/8" Brass 3 Sets of two Connectors (in- and outlet) for Base plate | 6 | N9306847 |
| Ultra Clean Connector Set - 1/4" SS 3 Sets of two Connectors (in- and outlet) for Base plate | 6 | N9306848 |
| Ultra Clean Connector Set - 1/8" SS 3 Sets of two Connectors (in- and outlet) for Base plate | 6 | N9306849 |
| Ultra Clean High Flow Connector Set - Brass 1/4" 3 Sets of two Connectors (in- and outlet) for Base plate | 6 | N9306850 |
| Ultra Clean High Flow Connector Set - 1/4" SS 3 Sets of two Connectors (in- and outlet) for Base plate | 6 | N9306851 |

Flush Caps

| Description | Pkg. | Part No. |
|--|------|-----------------|
| Ultra Clean Flush Cap Replacement Set 2 Flush Caps for Base Plate | 2 | N9306852 |
| Ultra Clean High Flow Flush Cap Replacement Set 2 Flush Caps for High Flow Base Plate | 2 | N9306853 |

O-Rings

| Description | Pkg. | Part No. |
|--|------|-----------------|
| Ultra Clean Base Plate O-ring Replacement Set Two sets of 10 O-rings for Base plate | 20 | N9306854 |

Wall Mounting

| Description | Part No. |
|---|-----------------|
| Ultra Clean Wall-mounting Bracket Set Suitable for genuine Ultra Clean Base plates | N9306855 |

Particle Filters

| Description | Part No. |
|---|-----------------|
| Ultra Clean 0.5 Micron Particle Filter (1/4" Brass) | N9306856 |
| Ultra Clean 0.5 Micron Particle Cup Filter Pack Replacement Filter Element - pack of 12 | N9306857 |

SAVE TIME AND MONEY

PerkinElmer Click-On inline Super Clean™ purifiers reduce your maintenance system downtime

Using the Click-On Connectors lets you change the trap without introducing contaminants into your system. Click-On connectors can replace a trap, without introducing impurities into the system. This in turn eliminates the need to flush the system.

The ability to add a Click-On Inline Super Clean™ Indicator after the stainless steel trap gives the user a clear visual indication of when to change the filter. This indicator may also be used as a standalone trap.

Features and Benefits

- Reduce system downtime with Click-On fast connectors
- No open gas line when changing the trap
- Helium Specific Glass Indicating Triple Trap is ideal for GC/MS

Stainless Steel Trap Kits

| Description | Connector (Qty) | Part No. |
|--|-----------------|-----------------|
| Combination: Oxygen/Moisture Trap | 1/8" Brass (2) | N9306108 |
| Combination: Oxygen/Moisture Trap | 1/8" SS (2) | N9306109 |
| Combination: Moisture/Hydrocarbons Trap | 1/8" Brass (2) | N9306117 |
| Combination: Moisture/Hydrocarbons Trap | 1/8" SS (2) | N9306118 |
| Triple: Oxygen/Moisture/Hydrocarbons Trap | 1/8" Brass (2) | N9306110 |
| Triple: Oxygen/Moisture/Hydrocarbons Trap | 1/8" SS (2) | N9306111 |
| Triple Gas Specific (He): Oxygen/Moisture/Hydrocarbons | 1/8" Brass (2) | N9306112 |
| Triple Gas Specific (He): Oxygen/Moisture/Hydrocarbons | 1/8" SS (2) | N9306113 |

Product Specifications

| Purifier Type | Gas Quality* | Max. Pressure | Max. Flow | Use For | H ₂ O | Capacity O ₂ | Hydrocarbons | Est. Lifetime |
|--|--------------|-----------------|-----------|---|------------------|-------------------------|--------------------|---------------|
| Moisture | 99.9999% | 11 bar, 160 psi | 25 L/min | Inert carrier gas He, Air, H ₂ | 21 g | NA | NA | > 3 years |
| Oxygen | 99.9999% | 11 bar, 160 psi | 25 L/min | Inert carrier gas | NA | 3,000 mL | NA | > 3 years |
| Hydrocarbons | 99.9999% | 11 bar, 160 psi | 25 L/min | Inert carrier gas Air, H ₂ | NA | NA | 36 g (as n-butane) | > 3 years |
| Combination Moisture/Hydrocarbons | 99.9999% | 11 bar, 160 psi | 25 L/min | Inert carrier gas He, Air, H ₂ | 10 g | NA | 18 g (as n-butane) | > 2 years |
| Indicating Triple Moisture/Oxygen/Hydrocarbons | 99.9999% | 11 bar, 160 psi | 25 L/min | Inert carrier gas He | 3 g | 400 mL | 5 g (as n-butane) | > 1 year |
| Triple Moisture/Oxygen/Hydrocarbons | 99.9999% | 11 bar, 160 psi | 25 L/min | Inert carrier gas | 6 g | 1,000 mL | 12 g (as n-butane) | > 2 years |

*Results @ 2 L/min



Stainless Steel Traps

| Description | Part No. |
|--|-----------------|
| Moisture Trap | N9306100 |
| Oxygen Trap | N9306101 |
| Hydrocarbons Trap | N9306102 |
| Combination: Oxygen/Moisture Trap | N9306103 |
| Combination: Moisture/Hydrocarbons Trap | N9306105 |
| Triple: Oxygen/Moisture/Hydrocarbons Trap | N9306104 |
| Triple Gas Specific (He): Oxygen/Moisture/Hydrocarbons | N9306106 |

Helium Specific Glass Indicating Triple Trap for your PerkinElmer Clarus GC/MS

This trap contains oxygen, moisture and hydrocarbons adsorbents in one trap and is packed and purged under helium.

The glass indicating trap clearly shows when the filter needs to be replaced with the use of color changes. The packing material is a silica-based environmentally friendly substitute for cobalt dioxide (blue) in the moisture indicator.

Available as a kit with the necessary 1/8" brass connectors, and as a replacement trap. This system is easy to install.

| Description | Connector (Qty) | Part No. |
|---|-----------------|-----------------|
| Indicating Glass Triple Gas Specific (He): Oxygen/Moisture/Hydrocarbons | Not Included | N9306107 |
| Indicating Glass Triple Gas Specific (He): Oxygen/Moisture/Hydrocarbons | 1/8" Brass (2) | N9306114 |
| Indicating Glass Triple Gas Specific (He): Oxygen/Moisture/Hydrocarbons | 1/8" SS (2) | N9306116 |

Hydrocarbon Trap



| | Part No. |
|------------------|-----------------|
| Hydrocarbon Trap | N9301192 |

Use our activated charcoal in-line trap to remove gaseous hydrocarbons (C5 and heavier) from nitrogen, hydrogen and inert carrier gas supplies. Recommended for use with purge and trap apparatuses, high-sensitivity FID operations and with GC carrier gases for trace analyses. Frits in each end prevent particulates from entering the gas stream. Trap is shipped filled with helium. Maximum pressure is 1000 psi (69 bar). Dimensions are 5 x 37 cm including fittings. Weight is 1.0 kg.

High Capacity Hydrocarbon Trap



| | Part No. |
|--------------------------------|-----------------|
| High Capacity Hydrocarbon Trap | N9301208 |

- Eliminates potential hydrocarbon background to insure best LC/MS results
- Contains 750 cc of preconditioned activated charcoal
- Stainless steel body. 1/4" brass compression fittings with ferrules for installation
- Maximum pressure 200 psi
- Recommended flow rate up to 2 Liters/minute
- Will remove hydrocarbon impurities (50 ppm or less) from inert gases, nitrogen and hydrogen at room temperature to low ppb range
- Capacity of 67 g. of hydrocarbons C5 and heavier
- 10 µm stainless steel porous frits protect gas stream from particulates
- Individually helium leak tested. Shipped filled with helium
- 2" OD x 20" L (including fittings)
- Weight 3.5 lb/1.6 kg

Indicating Oxygen Trap



| | Part No. |
|------------------------|-----------------|
| Indicating Oxygen Trap | N9301191 |

This high-efficiency indicator trap reduces oxygen to less than 0.1 ppm. Changes color from bright green to gray when adsorption capacity is depleted. Oxygen capacity for this compact unit is 0.05 g at STP. The non-contaminating, heavy-wall inner glass tube of adsorbent is protected from breakage by the outer plastic tube. Maximum pressure is 100 psi (6.9 bar). Dimensions are 3.2 x 43 cm including fittings. Weight is 0.2 kg.

Oxygen Trap



| | Part No. |
|-------------|-----------------|
| Oxygen Trap | N9301179 |

This high-capacity, high-efficiency trap is used for long-term protection of capillary column stationary phases against oxidation at GC operating temperatures. Can remove 3.5 g of oxygen and has an output efficiency of less than 10 ppb oxygen concentration at the outlet. Effective at removing sulfur compounds, such as hydrogen sulfide and mercaptans. Intended for use with non-oxidizing gases such as He, Ar, N₂, H₂ or CH₄, containing less than 1% oxygen. The trap is filled with 500 cc of active oxygen adsorbent that binds covalently with oxygen; no gas is generated from this reaction. Maximum pressure is 1000 psi (69 bar). Dimensions are 5 x 37 cm including fittings, weight is 1.2 kg.

Safe Glass Moisture Trap



| | Part No. |
|--------------------------|-----------------|
| Safe Glass Moisture Trap | N9301193 |

Gas contacts only glass, metal and the adsorbents for purity. The Drierite® indicator and molecular sieve 5A are packed in glass protected by an outer plastic tube in the event that the glass breaks. Unique loading design allows operation in any orientation without channeling. Designed for GC detectors that require high-purity gases and recommended for ELCD and ECD systems where moisture and contamination are a problem. Maximum pressure is 100 psi (6.9 bar). Dimensions are 3.2 x 26 cm including fittings. Weight is 0.3 kg.

Gas In-line Filter



| | Part No. |
|--------------------|-----------------|
| Gas In-line Filter | N9301178 |

The Gas In-line Filter Trap removes moisture, oil and dust from nitrogen or inert supply gases. It has 400 cc total volume of molecular sieve 5A and an indicator in a clear acrylic tube. The indicating Drierite® changes color at low relative humidity indicating that the packing must be changed. Base-plate version is available for free-standing orientation. Maximum pressure is 100 psi (6.9 bar). Dimensions are 6 x 43 cm including fittings. Weight is 1.0 kg.

PGX-H₂ Plus Pure Gas Hydrogen Generators

Pure gas hydrogen generator employ the newest membrane technology available for the safe production of pure hydrogen gas. This patented design is ideal for operation with gas analyzers, as fuel gas for flame tools, or as a source for pure hydrogen in plasma chambers and other isolated environments. Electrolytic membrane technology is preferred over alternative hydrogen generating techniques because it is clean, requires less maintenance and there is no need to store chemicals to maintain operation. The generators offer silent operation and require only deionized or distilled water with no caustic solutions which can affect the purity of the hydrogen.

Technical Specifications for PGX-H₂ Plus Models

| Specifications | |
|---------------------------|--|
| Purity | 99.999% / hydrocarbon free < 0.1 ppm |
| Delivery Pressure | 20 - 1555 psig / 1.4 - 11 barg |
| Height | 43 cm (16.9 in) |
| Width | 23 cm (9.1 in) |
| Depth | 36 cm (14.2 in) |
| Weight | 20 kg (44 lbs) |
| Ambient Temperature Range | -20 °C to + 60 °C (-4 °F to + 140 °F) |
| Water Quality | Deionized or distilled <10 uS conductivity |
| Supply Voltage Range | 230V/50-60Hz - 110V/60Hz - 100V/60Hz |
| Fitting | 1/8" for the H ₂ outlet |



PGX-H₂ Plus Generator Models

| Flow Rate | Part No. |
|-------------|-----------------|
| 100 mL/min | N9308577 |
| 160 mL/min | N9308578 |
| 250 mL/min | N9308579 |
| 500 mL/min | N9308580 |
| 1000 mL/min | Not Available |

PGX-H₂ Plus Generator Replacement Parts

| Description | Part No. |
|---|-----------------|
| Desiccant Cartridge, Fitting and Refill Kit | N9306064 |
| Desiccant Refill (sufficient for 3 cartridge refills) | N9306065 |
| Deionizer Bag | N9307097 |

NM-H₂ Plus Pure Gas Hydrogen Generators

A Safe Source of Hydrogen

Both the PGX-H₂ and the No Maintenance Hydrogen Generators have an auto shutoff procedure that places the units in standby in the event of an internal error and selectable alarms allow the user to be informed whenever operating conditions vary from the set point.

The No Maintenance (NM-H₂) Hydrogen Pure Gas Generators employ the newest membrane technology available for electrolytic production of pure hydrogen gas, including exclusive no maintenance auto-drying technology.

Technical Specifications for NM-H₂ Plus Models

| Specifications | |
|---------------------------|--|
| Purity | 99.9999% / hydrocarbon free < 0.1 ppm |
| Delivery Pressure | 20 - 1555 psig / 1.4 - 11 barg |
| Height | 43 cm (16.9 in) |
| Width | 23 cm (9.1 in) |
| Depth | 36 cm (14.2 in) |
| Weight | 20 kg (44 lbs) |
| Ambient Temperature Range | -20 °C to + 60 °C (-4 °F to + 140 °F) |
| Water Quality | Deionized or distilled <10 uS conductivity |
| Supply Voltage Range | 230V/50-60Hz - 110V/60Hz - 100V/60Hz |
| Fitting | 1/8" for the H ₂ outlet |

NM-H₂ Plus Generator Models

| Flow Rate | Part No. |
|-------------|-----------------|
| 100 mL/min | N9308581 |
| 160 mL/min | N9308582 |
| 250 mL/min | N9308583 |
| 500 mL/min | N9308584 |
| 1000 mL/min | N9308585 |



NM-H₂ Plus Generator Accessories

| Description | Part No. |
|--|-----------------|
| I/O Board | N9307094 |
| Cable for Cascading* | N9307093 |
| Remote Control RS-232 (includes converter, cables and software)* | N9307095 |
| Auto Refill * | N9307096 |

* Requires I/O Board

NM-H₂ Plus Generator Replacement Parts

| Description | Part No. |
|------------------------|-----------------|
| Deionizer Bag | N9307097 |
| Triangle Deionizer Bag | N9307098 |

High Purity Hydrogen Generators - Parker Domnick Hunter

The Parker Domnick Hunter high purity hydrogen gas generators offer the optimum combination of safe operation, reliability and performance. Utilizing field proven PEM cell technology, hydrogen is produced on demand from deionized water and electricity at low pressure and with minimal stored volume. Innovative control software allows unrivalled operational safety and reliability. These models ideally supply fuel gas to all known GC combustion detectors used in today's laboratory workflows.

Technical Specifications

| Specifications | |
|---------------------------|---|
| Purity | 99.999% |
| Delivery Pressure | 5 - 100 psi/g |
| Height | 46 cm (17.9 in) |
| Width | 35 cm (13.5 in) |
| Depth | 44 cm (17.2 in) |
| Weight | 20 kg (41.9 lbs) |
| Ambient Temperature Range | +5 °C to +40 °C (+41 °F to +104 °F) |
| Water Quality | Deionized, ASTM® II, >1MΩ, <1 μS, filtered to <100 μm |
| Supply Voltage Range | Universal 120/230 V ± 10% (60/50 Hz) |
| Fitting | Hydrogen Outlet: 1/8" compression fitting Water Drain: quick release push in fitting |



High Purity Generator Models

| Flow Rate | Part No. |
|------------------------|-----------------|
| 160 mL/min (20H Model) | N9303225 |
| 250 mL/min (40H Model) | N9303226 |
| 500 mL/min (60H Model) | N9303227 |
| 1000 mL/min | Not Available |

Ultra High Purity Hydrogen Generators - Parker Domnick Hunter

The Parker Domnick Hunter high purity hydrogen gas generators offer the optimum combination of safe operation, reliability and performance. Utilizing field proven PEM cell technology, hydrogen is produced on demand from deionized water and electricity at low pressure and with minimal stored volume. Innovative control software allows unrivalled operational safety and reliability. These models ideally supply fuel gas to all known GC combustion detectors used in today's laboratory workflows.

Technical Specifications

| Specifications | |
|---------------------------|---|
| Purity | 99.99995% |
| Delivery Pressure | 10 - 100 psi/g |
| Height | 46 cm (17.9 in) |
| Width | 35 cm (13.5 in) |
| Depth | 47 cm (18.5 in) |
| Weight | 21 kg (45.2 lbs)* |
| Ambient Temperature Range | +5 °C to +40 °C (+41 °F to +104 °F) |
| Water Quality | Deionized, ASTM® II, >1MΩ, <1 μS, filtered to <100 μm |
| Supply Voltage Range | Universal 120/230 V ± 10% (60/50 Hz) |
| Fitting | Hydrogen Outlet: 1/8" compression fitting Water Drain: quick release push in fitting |

* 1100 mL/min model is 24 kg (51.8 lbs)

Ultra High Purity Generator Models

| Flow Rate | Part No. |
|-----------------------------|-----------------|
| 160 mL/min (20H-MD Model) | N9303201 |
| 250 mL/min (40H-MD Model) | N9303202 |
| 500 mL/min (60H-MD Model) | N9303203 |
| 1100 mL/min (110H-MD Model) | N9303204 |



Zero and Ultra Air Generators

The Zero and Ultra Zero Air Generators produce laboratory grade purified air for FID (flame ionization detectors) and other detectors. Designed with safety and convenience in mind, this system will generate purified and hydrocarbon free air from an existing in-house oil-free compressed air supply, eliminating the need for inconvenient high-pressure gas cylinders. Eliminating gas cylinders reduces annual operating costs associated with materials, labor, and down-time.

The Zero/Ultra Zero Air Generator series removes HC pollutants to less than 0.1 ppm, and all forms of particles. Operation of the generator requires low levels of electrical power consumption. This complete turnkey system is engineered with the highest quality components, is easy to install, and requires minimal annual maintenance. The Ultra Zero Air Generators will remove CO and HC pollutants to less than 0.1 ppm, and NO_x contaminants to 1 ppm. Carbon dioxide is also removed to about 1 ppm levels.

Specifications for Zero and Ultra Zero Air

| | |
|---|----------------|
| Outlet Hydrocarbon Concentration | < 0.1 ppm |
| Outlet Carbon Monoxide Concentration | < 0.1 ppm |
| Outlet Particles < 0.5 Microns Removed | 99.99% |
| Outlet Air Temperature | Ambient +15 °C |
| Max Inlet Hydrocarbon Concentration | 100 ppm |
| Maximum Outlet Pressure | 6.5 bar |
| Max Inlet Carbon Monoxide Concentration | 50 ppm |
| Max Inlet Temperature | 40 °C |
| Inlet Pressure Range (regulated to 7 bar) | 4.5 – 10 bar |
| Inlet Port | ¼" NPT |
| Outlet Port | ⅛" NPT |

Specifications for Zero Air

| Outlet Zero Air | Maximum Continuous Output Flow Rate | Electrical Requirements | Temperature/ Pressure Control Board | Part No. |
|-----------------|-------------------------------------|--------------------------|-------------------------------------|-----------------|
| 1.5 L/min | 1.5 L/min | 230/115 VAC 250 W max | N/A | N9307075 |
| 3.0 L/min | 3.0 L/min | 230/115 VAC 250 W max | Included | N9307076 |
| 6.0 L/min | 6.0 L/min | 230/115 VAC 250 W max | Included | N9307077 |
| 15.0 L/min | 15.0 L/min | 230/115 VAC 480 W max | Included | N9307078 |
| 30.0 L/min | 30.0 L/min | 230/115 VAC 480 W max | Included | N9307079 |

| Dimension | Part No. |
|--|-----------------|
| 1.5 L/min of Air (Without Compressor) | N9307075 |
| 3.0 L/min of Air (Without Compressor) | N9307076 |
| 6.0 L/min of Air (Without Compressor) | N9307077 |
| 15.0 L/min of Air (Without Compressor) | N9307078 |
| 30.0 L/min of Air (Without Compressor) | N9307079 |



WALL MOUNTABLE

Ultra Zero Air Generators

Features and Benefits

- Flow rate: < 0.1 ppm HC; < 0.1 ppm CO; < 1 ppm NO_x; < 5 ppm CO₂
- Produce laboratory-grade purified air for the most accurate and convenient calibration of testing equipment
- Designed with safety and convenience in mind, this system will generate purified air from an existing in-house oil-free compressed air supply, eliminating the need for inconvenient high-pressure gas cylinders
- Eliminate gas cylinders reducing annual operating costs associated with materials, labor and downtime, and reduces risk of injury to workers
- Will remove CO and HC pollutants to less than 0.1 ppm and NO_x contaminants to 1 ppm. Carbon dioxide is also removed to about 1 ppm levels. Operation of the generator requires low levels of air consumption and electrical power
- Fully supported by PerkinElmer Service Organization

Specifications for Ultra Zero Air

| Outlet Ultra Zero Air | Outlet Carbon Dioxide Concentration | Outlet Nitrogen Oxides Concentration | Outlet Dewpoint | Electrical Requirements | Part No. |
|-----------------------|-------------------------------------|--------------------------------------|-----------------|--------------------------|-----------------|
| 1.5 L/min | < 5 ppm | < 0.1 ppm | < -70 °C | 230/115 VAC 270 W max | N9307081 |
| 3.0 L/min | < 10 ppm | < 1 ppm | < -50 °C | 230/115 VAC 270 W max | N9307082 |
| 6.0 L/min | < 10 ppm | < 1 ppm | < -50 °C | 230/115 VAC 270 W max | N9307083 |
| 15.0 L/min | < 10 ppm | < 1 ppm | < -50 °C | 230/115 VAC 500 W max | N9307080 |

| Description | Part No. |
|--|-----------------|
| 1.5 L/min of Air (Without Compressor) | N9307081 |
| 3.0 L/min of Air (Without Compressor) | N9307082 |
| 6.0 L/min of Air (Without Compressor) | N9307083 |
| 15.0 L/min of Air (Without Compressor) | N9307080 |

All models come WITHOUT a compressor.
Oil Free Compressor Required.

GAS MANAGEMENT - ZERO AND ULTRA ZERO AIR GAS GENERATORS

Zero Air Generators - Parker Domnick Hunter

Parker Zero Air Gas Generators produce zero grade air from compressed air through catalytic oxidation. This zero air is used as an oxidant supply to GC-FIDs and as a zero-grade gas supply/zero reference gas for process analytical instruments. These generators produce zero-grade air with less than 0.05 ppm hydrocarbon content, measured as methane, enabling a more stable baseline as compared to conventional sources of fuel air.

| Model | Flow Rate (L/min) | Air Inlet @ 58–145 psig (L/m) | Voltage | Part No. (120 V) |
|------------|-------------------|-------------------------------|---------|------------------|
| UHP-35ZA-S | 3.5 | 4.2 | 120V | N9303206 |
| UHP-35ZA-S | 3.5 | 4.2 | 230V | N9303205 |
| UHP-35ZA-S | 5.0 | 6.0 | 120V | N9303208 |
| UHP-35ZA-S | 5.0 | 6.0 | 230V | N9303207 |
| UHP-35ZA-S | 15 | 18 | 120V | N9303210 |
| UHP-35ZA-S | 15 | 18 | 230V | N9303209 |
| UHP-35ZA-S | 30 | 35 | 120V | N9303212 |
| UHP-35ZA-S | 30 | 35 | 230V | N9303211 |

Size: 17.9" H x 13.4" W x 16.7" D

Weight: 31.3 lbs.

Organic Purity (ppm): <0.1

Delivery Pressure (psi/g): 58–145

Ambient Temperature Range: 41–104 °F

Required Inlet Air Quality:

Clean dry compressed air ISO8573-1:2001 Class 3.2.1

Supply Voltage Range: 120V/60 Hz or 230 V/50-60 Hz ±10%

Port Connections

Outlet (N9303205 and N9303206): 1/8" Compression Fitting

Inlet (N9303205 and N9303206): 1/8" Compression Fitting

Outlet (N9303207-N9303212): 1/4" Compression Fitting

Inlet (N9303207-N9303212): 1/4" Compression Fitting

ULTRA QUIET OIL FREE



PerkinElmer's GC Quiet Compressor

This industrial ultra quiet compact oil free 6 gallon compressor that can be utilized in the immediate laboratory area for the supply of clean air.

Horse Power: 0.60

Power Requirements: 115V/220V/50 – 60Hz

Output: 2.5 CFM

Output: 67 L/Min

Max Pressure: 100 PSI

Max Pressure: 7 bar

Operating Pressure PSI: 80 – 100

Operating Pressure Bar: 6 – 7

Noise Level: 62 db/A

Tank Size: 6.0 Gal.

Tank Size Liter: 24 L

Dimensions: 16 x 16 x 20 in.

Weight: 54 lbs.

Packed Dimensions: 19 x 18 x 23

Packed Weight: 58 lbs.

Features and Benefits:

- Ultra quiet for use in the laboratory area
- Compact size and light weight
- Commercial/Industrial grade
- 1 Year warranty on workmanship
- 5.0 micron pre-filter and regulator
- Internally powder coated air tank to prevent rust
- Pressure switch for automatic operation

| Description | Part No. |
|-------------|----------|
| 115V 60Hz | N9306291 |
| 220V 60Hz | N9306292 |
| 220V 50Hz | N9306293 |



Ultra Quiet Compact Oil-free Compressor

PerkinElmer is expanding its product portfolio in response to customer requests for an industrial ultra quiet compact oil-free compressor that can be utilized in the immediate laboratory area for the supply of clean dry air. As with all PerkinElmer products, this 110 liter per minute air compressor has been rigorously tested to meet or exceed our industry leading standards.

Horse Power: 0.75

Power Requirements: 115V/220V/50 – 60Hz

Output: 4.4 CFM

Output: 110 L/Min

Max Pressure: 100 PSI

Max Pressure: 7 bar

Operating Pressure PSI: 80 – 100

Operating Pressure Bar: 6 – 7

Noise Level: 57 db/A

Tank Size: 1.57 Gal.

Tank Size Liter: 6 L

Dimensions: 34.7 x 13.4 x 22.4 in.

Weight: 103 lbs.

Packed Dimensions: 38 x 15 x 25

Packed Weight: 125 lbs.

Features and Benefits:

- Features a built-in desiccant dryer providing clean, dry, and particle free air at -40° F dew point
- Excellent for Gas Chromatography instrument applications with air generators applications
- Ultra quiet for use in the laboratory area
- Ease-of-use with built-in rolling casters and convenient handle
- Commercial/Industrial Grade
- 1 year warranty on workmanship

| Description | Part No. |
|-------------|----------|
| 115V 60Hz | N9306350 |
| 220V 50Hz | N9306351 |
| 220V 60Hz | N9306352 |



Portable Gas Leak Detector

The new PerkinElmer compact handheld electronic gas leak detector is the ideal solution for detecting gas leaks in your Gas Chromatography systems. Leaks in your system waste gas and can cause detector noise, baseline instability, and shorter column life. This portable unit detects minute leaks of any gas with thermal conductivity different from air. The reference gas inlet draws in ambient air for comparison to air drawn into the sample probe. A leak is detected by both LED bar graph display and audible alarm.

Detectable Gases

| Gas Type | Minimum Detectable Leak Rate (atm cc / sec) | Indicating LED Light Color |
|----------------|---|----------------------------|
| Helium | 1.0×10^{-5} | Red |
| Hydrogen* | 1.0×10^{-5} | Red |
| Nitrogen | 1.4×10^{-3} | Yellow |
| Argon | 1.0×10^{-4} | Yellow |
| Carbon Dioxide | 1.0×10^{-4} | Yellow |

Battery: Rechargeable Ni-MH internal battery pack (6 hours normal operation)

Universal Power Adapter Set: US, UK, European, Australian plugs included

Temperature Range: 32 – 120 °F (0 – 48 °C)

Humidity Range: 0 – 97%

Warranty: 1 Year

Certifications: CE, Japan

Compliance: WEEE, ROHS

Features and Benefits

- Sleek ergonomic, hand-held design with rugged side grips
- Automatic shut-off capabilities
- Optimized sample flow path
- LED readout and audible alarm

| Description | Part No. |
|-----------------------------------|-----------------|
| Portable Electronic Leak Detector | N9306089 |
| Soft Carrying Case | N9306142 |
| Probe (Fine Tip) | N9306063 |

* Caution: The PerkinElmer leak detector is not designed for determining leaks in a combustible environment. This unit may be used for determining trace amounts of hydrogen in a GC environment only.

ESSENTIAL GC LAB SUPPLIES

MiniTemp MT4 Non-contact Temperature Measurement with Laser Sighting

Features and Benefits

- Displays thermal measurement readings in °C or °F
- Easy point and shot infrared technology in a pocket size configuration
- Great for instrument thermal test confirmation, including GC injector port and detector measurements, thermostatted LC vials, and enzymatic hydrolysis baths



Specifications

| Model | MiniTemp MT |
|-----------------------------------|--|
| Temperature Range | -18 to 400 °C (0 to 750 °F) |
| Distance to Spot Size (D:S) | 8:1 |
| Response time | 500 m/sec |
| Emissivity | Pre-set at 0.95 |
| Accuracy | ±2%, or ±2 °C (±3 °F) whichever is greater |
| Typical Distance to Target (Spot) | Up to 1.5 m (4 ft) |
| Laser Sighting | Yes |

The popular MiniTemp MT4 also includes single dot laser sighting to assist with aiming. 9 volt battery included. Recalibration is not available.

| Description | Part No. |
|--------------|-----------------|
| MiniTemp MT4 | N9306074 |

Basic Tool Kit

Kit Includes: Open-end Wrench Set (6 pc), Screwdriver Set (6 pc.), Adjustable Wrench (6 in), Chain Nose Pliers (narrow), Wire Cutters, and Wire Strippers

| Description | Part No. |
|---|-----------------|
| Tools Come in a Tool Box for Easy Storage and Use | N9301327 |

Deluxe Tool Kit

Kit Includes: Open-end Wrench Set (6 pc.), Screwdriver Set (6 pc.), Adjustable Wrench (6 in), Chain Nose Pliers (narrow), Wire Cutters, Wire Strippers, Slip-joint Pliers (6 in), Long Nose No. 5 Stainless Steel Tweezers (4-3/8 inches), Needle File Set (6 pc.), Allen Key Set (11 pc. imperial sizes), and Allen Key Set (9 pc. metric sizes)

| Description | Part No. |
|--|-----------------|
| Shipped in a Plastic Tool Box for Convenient Storage | N9301328 |

Digital Bubble Flow Meter

The PerkinElmer Model 520 is a volumetric flow meter. It can measure the flow rate of any gas or combination of gases, such as air, without adjustment. The flow meter has a digital display and a single push-button input. It is made of stainless steel and anodized aluminum. It comes with a certificate of calibration, and is accurate to $\pm 3\%$. The Model 520 can measure flow rates of 0.5 to 500 mL/min.



Features and Benefits

- 0.5 to 500 mL/min flow rate with digital display
- Volumetric flow measurement
- Accurate to $\pm 3\%$ of measured flow rate

| Description | Part No. |
|---|-----------------|
| Digital Bubble Flow Meter | N9302974 |
| Replacement Glass for Digital Bubble Flow Meter | N9303429 |

PerkinElmer Electronic Flowmeter 1000

The PerkinElmer Flowmeter 1000 allows for rapid real-time flow measurements. Flow rates measured in mL/min. (volumetric flow). The PerkinElmer Flowmeter 1000 can quickly calculate split ratios. Ratios are displayed in real time. Flowmeter not compatible with corrosive or flammable gases. Portable operation.

Features and Benefits

- Flow range 0.1–1,000 mL/min.
- Operating temperature 0 to 45 °C
- Traceable to NST primary standard
- Split ratio mode and accuracy $\pm 3\%$
- LCD alphanumeric display

| Description | Part No. |
|---------------------------------------|-----------------|
| PerkinElmer Electronic Flowmeter 1000 | N9307029 |

Soap Bubble Flow Meters

The glass soap bubble flow meters are calibrated in 1 and 10 mL two-stage or 1, 10 and 100 mL three-stage for easy flow reading. Bubble meters come complete with liquid soap, rubber squeeze bulb, miscellaneous-sized plastic tube pieces to adapt to various fittings, and instructions.

| Description | Part No. |
|-------------|-----------------|
| Two-stage | 00230522 |
| Three-stage | N9300081 |

PerkinElmer FlowMark™ Electronic Flowmeter

PerkinElmer's FlowMark™ flowmeter is specifically designed for use with gas chromatography (GC) instruments. The probe is applied directly to the gas flow stream and the measured flow rate is presented on the LCD screen. Units of flow are measured in mL/min. This unit provides continuous real-time measurements of gas streams ranging from 0.50 mL/min to 500 mL/min. Because the technology uses volumetric flow measurement, the unit is compatible with all laboratory gases. The flowmeter is designed to measure clean, dry, non-corrosive gases.



Features and Benefits

- Measures volumetric flow for all gases across a range of 0.5–500 mL/min.
- NIST traceable calibration
- Explosion-proof rating for flammable and explosive gas atmospheres
- Accuracy of $\pm 2\%$ of flow or ± 0.2 mL/min., whichever is greater
- Over range indicator
- Auto shut-off feature
- Ergonomic design and side grips for comfort
- Measures most gas types
- Convenient storage case included
- CE, Ex (Compliance: WEEE, RoHS) certified
- Uses 2-AA batteries
- Data output via USB port
- Re-calibration service available
- Designed to measure clean, dry, non-corrosive gases
- 1 year warranty

| Description | Part No. |
|--|-----------------|
| FlowMark™ Electronic Flowmeter | N9307086 |
| Recalibration service for flowmark flowmeter | N9307085 |
| Soft Carrying Case | N9306142 |



PerkinElmer offers a wide selection of GC and GC/MS standards. Each solution is supplied with a comprehensive Certificate of Analysis that documents quality and assurance to the highest level obtainable by a Calibration Standard.

Organic Certified Reference Materials from PerkinElmer are a new addition to an already extensive organic product line designed to enhance your one-stop shopping experience. Each new standard is provided in convenient 1.2 mL ampules to minimize waste and comes with a pre-labeled amber glass storage vial with cap for easy use.

To ensure customer satisfaction, our Organic Mixes are prepared at concentration levels that take into consideration a number of factors including: vapor pressure, evaporation, breakdown rates and dilution schemes. PerkinElmer goes the extra step by analyzing each organic standard on the Clarus 600 GC and GC/MS state-of-the-art instrumentation to ensure that the standard conforms to the customer's exact needs.

For customer ease, all Organic Standards are prepared with a precision of +/- 0.5% and accompanied with a comprehensive Certificate of Analysis (lot specified by part number). Data packs are also available upon request. These include a chromatogram of the standard and quantitative report listing the values for each analyte.

Method 8260B for Water and Solid Waste Matrices

Method 8260B is an analytical method that uses a GC/MS equipped with a capillary column to perform the separation of the volatile organic compounds found in water and a variety of solid waste matrices.

Method 524.2 is an analytical method that uses a purge and trap device for sample preparation and a GC/MS equipped with a capillary column to perform the separation of volatile organic compounds.

Volatile Organics Combination Blend

Contains all analytes in Mixes A, C and D.

Method SW-846 is an analytical method which utilizes a Clarus 600 GC to perform the separation of the volatile organic components found in a variety of solid waste matrices. To detect the GC eluant a Clarus 600 GC/MS is used.

| Description | Part No. |
|--|----------|
| 1.2 mL @ 2,000 µg/mL in P & T Methanol | N9331047 |

Method 8260B Standards

| Description | Part No. |
|---|----------|
| Alternate Four-Component Surrogate Standard for Method 8260B | |
| 1.2 mL @ 2,000 µg/mL in P & T Methanol | N9331042 |
| Internal Standard for Method 8260B | |
| 1.2 mL @ 2,000 µg/mL in P & T Methanol | N9331041 |

Ketones for Method 8260B

| Description | Part No. |
|--|----------|
| 1.2 mL @ 2,000 µg/mL in P & T Methanol | N9331043 |

Mix B Purgeable Gases for Methods 8260B/524.2

| Description | Part No. |
|--|----------|
| 1.2 mL @ 2,000 µg/mL in P & T Methanol | N9331048 |

NEW

8000 Series Solid and Hazardous Waste Methods

Resource Conservation And Recover Act (Rcra) Under Sw-846, "Test Methods For Evaluating Solid Waste"

Features and Benefits

- Method 8080A contains detailed operating procedures to be followed by laboratories analyzing solid and liquid matrices. It is a method that uses a GC/ECD to perform the separation of the selected pesticides following concentration and clean up of an extract for aqueous or solid samples
- Method 8082 is used to determine the concentrations of PCB's, either as individual congeners or Aroclors by GC/ECD.

Method 8082 PCB's (polychlorinated biphenyls) Standards Kit

Method 8082 is used to determine the concentration of PCB's either as individual congeners or Aroclors. A Clarus 600 GC with a capillary column is used to perform the separation. To detect the eluent, an ECD (electron capture detector) or ELCD (electrolytic conductivity detector) is used.

| Description | Part No. |
|--------------------------------|----------|
| 1.2 mL @ 1,000 µg/mL in Hexane | N9331028 |

Method 8270C Standards

Method 8270C is an analytical method which utilizes a Methylene Chloride extraction of aqueous sample or Methylene Chloride: Acetone extraction of solid sample and a Clarus 600 GC equipped with a capillary column to perform the separation of the compounds. To detect the GC eluant a Clarus 600 GC/MS is used.

| Description | Part No. |
|--|----------|
| Semi-Volatile Calibration Standard for Method 8270C | |
| 1.2 mL @ 1,000 µg/mL in Hexane | N9331030 |
| Internal Standard for Method 8270C | |
| 1.2 mL @ 2,000 µg/mL in Methylene Chloride/Benzene | N9331036 |

Method 8270C Mixes

| Description | Part No. |
|--|----------|
| HICAL-Acids Mix for Method 8270C | |
| 1.2 mL @ 2,000 µg/mL in Methylene Chloride | N9331031 |
| Analyte Mix for Method 8270C | |
| 1.2 mL @ 2,000 µg/mL in Methanol | N9331032 |
| Balance Mix for Method 8270C | |
| 1.2 mL @ 2,000 µg/mL in Methylene Chloride | N9331033 |

Method 8270C Surrogates

| Description | Part No. |
|--|----------|
| Acid Surrogate for Method 8270C | |
| 1.2 mL @ 2,000 µg/mL in Methanol | N9331037 |
| Base Neutral Surrogate for Method 8270C | |
| 1.2 mL @ 2,000 µg/mL in Methylene Chloride/Acetone | N9331038 |

600 Series Wastewater Methods Clean Water Act "Wastewaters"

Method 624 Standards Kit for Volatile Organic Compounds

Contains: N9331060, N9331061, N9331062, N9331063.

The U.S. EPA Method 624 is an analytical method which utilizes a TurboMatrix Headspace Purge and Trap instrument for sample prep and a Clarus 600 GC equipped with a packed column to perform the separation of the volatile organic compounds found in a 5 mL sample of municipal or industrial wastewater. To detect the eluant a Clarus 60 GC/MS is used.

| Description | Part No. |
|---|----------|
| 1.2 mL @ 2,000 µg/mL in P & T Methanol | N9331064 |
| Mix A for Method 624 | |
| 1.2 mL @ 2,000 µg/mL in P & T Methanol | N9331060 |
| Purgeable Gases Mix B for Method 624 | |
| 1.2 mL @ 2,000 µg/mL in P & T Methanol | N9331061 |
| Mix C for Method 624 | |
| 1.2 mL @ 2,000 µg/mL in P & T Methanol | N9331062 |
| Mix D for Method 624 | |
| 1.2 mL @ 2,000 µg/mL in P & T Methanol | N9331063 |

Method 8100

Method 8100 is a method for the analysis of polynuclear aromatic hydrocarbons. A Clarus 600 GC is used to perform the separation of compounds with an FID (flame ionization detector) to detect the eluent.

Method 625

Method 625 is an analytical method that uses a methylene chloride extraction of municipal or industrial wastewater, concentrated to 1 mL and a GC/MS equipped to perform the separation of acid and base neutral extractable fractions.

| Description | Part No. |
|--|----------|
| Polynuclear Aromatic Hydrocarbons for Method 8100/625 | |
| 1.2 mL @ 2,000 µg/mL in Methylene Chloride/Benzene | N9331044 |
| Polynuclear Aromatic Hydrocarbons Mix B for Method 8100 | |
| 1.2 mL @ 1,000 µg/mL in Methylene Chloride/Benzene | N9331045 |
| Surrogate Standard for Method 8100 | |
| 1.2 mL @ 2,000 µg/mL in Methylene Chloride | N9331046 |

HUMAN HEALTH

ENVIRONMENTAL HEALTH



IR READY
FOR ANY
CHALLENGE



Reach new heights in IR with Frontier™. This innovative IR spectrometer combines superb sensitivity with optical flexibility, for superior performance in demanding applications. Offering optimized sampling options, Frontier satisfies any IR need and can be expanded as research goals develop. We've harnessed 65 years of expertise to create our most powerful, adaptable IR solution yet. Helping protect consumers and the environment more quickly and accurately than ever before.

www.perkinelmer.com/frontier



PerkinElmer
For the Better



MATERIALS CHARACTERIZATION



From the measurement of DNA purity to characterization of the most advanced engineered materials, we provide the widest range of solutions available from one company. FT-IR, FT-NIR, UV, UV/Vis, Fluorescence, DSC, TGA, STA, TMA, DMA — we have solutions for every lab and every budget.

Our expertise in these technology means you can rely on us. Do you need a simple accessory that provides results with a push of a button, or a high-end lamp with unparalleled sensitivity? What about flexible sample sizes and reduced sample setup time? Higher lab productivity? No problem.

Whatever challenge you face in material characterization, we can help you solve it. After all, we created the first commercial IR and FT-IR systems over 60 years ago. Since then, we have continually pioneered the technologies, consumables and supplies to help you learn more about the performance and structure of the materials you analyze at the molecular level.

Define your challenge, and we will help you meet it.

Infrared Spectroscopy

| | |
|----------------------------------|---------|
| Accessories Overview | 248-249 |
| Application Packs | 266 |
| ATR Accessories | 250-253 |
| Desiccant and Laser Kits | 263 |
| Diffuse Reflectance Accessories | 254 |
| FT-NIR Accessories | 267 |
| Imaging Accessories | 264 |
| Oil Express Consumables | 262 |
| Portability Packs | 262 |
| Presses | 261 |
| Reference Materials | 263 |
| Sampling and Starter Kits | 265 |
| Specular Reflectance Accessories | 255 |
| Transmission Accessories | 256-260 |

UV/Visible and Fluorescence

| | |
|----------------------------------|---------|
| Cells | 270-274 |
| Cell Changers | 276 |
| Cell Holders | 275 |
| General Purpose Optical Bench | 282 |
| Fiber Optics | 282 |
| Fluorescence | 284-289 |
| Integrating Spheres | 280 |
| Lamps | 268 |
| Polarimetry | 283 |
| Polarizers, Depolarizers, Sipper | 281 |
| Reference Materials | 269 |
| Specular Reflectance Accessories | 279 |
| Thermostating Accessories | 277-278 |

Thermal and Elemental Analysis

| | |
|--------------------------------|---------|
| DMA Accessories and Supplies | 296-297 |
| DSC Supplies | 290-292 |
| Elemental Analysis Consumables | 298-299 |
| TGA / STA Supplies | 294-295 |
| TMA Supplies | 293 |

IR READY FOR ANY SAMPLING CHALLENGE

Accessories play an important role in FT-IR analysis. Selection of the correct accessory speeds your analyses, increases repeatability of results and minimizes errors. We manufacture a host of high quality, easy-to-use accessories and partner with leading industry providers of branded IR accessories to provide a full range of compatible tools to extend the scope and capabilities of your FT-IR instrument.

From simple transmission spectroscopy techniques to more advanced research analysis, our premium “plug-and-play” accessories, such as UATR and diffuse reflectance, offer ultimate performance with minimum set-up and calibration through their convenient auto-recognition set-up design.



With the widest range of both PerkinElmer designed and manufactured accessories and well-known brands of accessories from our global partners, our selection offers you the best solution for your laboratory's needs.

INFRARED SPECTROSCOPY SAMPLING TECHNIQUES

Attenuated Total Reflectance (ATR)

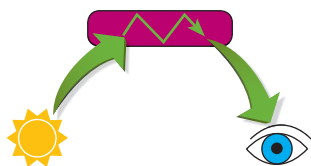

A sampling technique which requires little to no sample preparation. A beam of infrared light passes through the ATR crystal and is reflected off the surface of the sample. The reflection forms an evanescent wave which is collected by a detector.

SAMPLE TYPES: Solid, Liquid, Powder

APPLICATIONS: Identification of powders and polymers. Quantitative measurements for liquids, including aqueous solutions.

Diffuse Reflectance

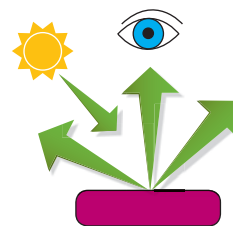

Diffusely scattered light is collected when a beam of light reflects off a rough, matt surface e.g. powder or fiber.

SAMPLE TYPES:
Powders, Fibers, Solids with Rough Surface

APPLICATIONS:
Characterization of minerals and hard plastic materials.

Whatever your application or instrument, we have the right sampling accessory for you.

Not every accessory is ideal for every application. That's why we offer a complete line of sampling options for your Spectrum One/100/400/65, Spectrum Two or Frontier instruments. With three different levels of sampling accessories to choose from, we'll help you find the solutions that best suit your laboratory needs.

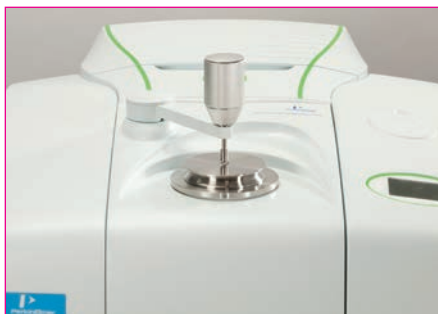

Premium: these top tier accessories offer you the most sampling flexibility. With "plug-and-play" accessory recognition and auto-alignment, you'll be able to quickly and easily analyze a wide range of sample types.



Branded: the quality of your instrument and that of the sampling accessory are equally important to your analysis. These mid-level accessories, manufactured by Specac, PIKE and others, have been tested and are approved for use on our PerkinElmer FT-IR systems.



Value: an affordable choice for laboratories that need a simple but effective sampling solution. With manual alignment, these accessories provide you with the performance you need to analyze most samples.

Specular Reflectance

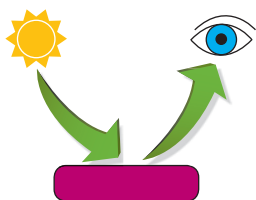

A mirror-like reflection occurs when a beam of light strikes a smooth, shiny surface such that the angle of incidence equals the angle of reflection.

SAMPLE TYPES: Thin Films on Substrates

APPLICATIONS: Analysis of coatings on metallic substrates, Langmuir Blodgett films and self-assembled monolayers.

Transmission

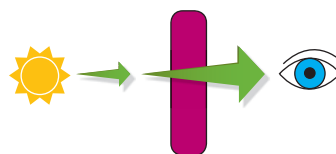

When radiation passes through a body a proportion of the energy is absorbed by the sample and the remainder travels on to the detector.

SAMPLE TYPES: Solid, Liquid, Gas

APPLICATIONS: Quantitative determination of fuel properties, e.g. biodiesel, high-resolution gas-phase spectroscopy

PerkinElmer UATR Accessory

PREMIUM



An excellent general accessory for the analysis of solids and liquids. The UATR produces high quality spectra through the use of a pressure arm allowing good contact of the sample with the diamond crystal. The pressure arm force indicator ensures first-class sample-to-sample and operator-to-operator reproducibility. The accessory is recognized when it is placed

in the sample compartment, the optics are automatically optimized and the system is ready to be used without additional alignment.

| Description | Spectrum One/100/400/65 | Spectrum Two | Frontier |
|---|-------------------------|--------------|----------|
| UATR Diamond/ZnSe ATR (Single Reflection) | L1250050 | L1600107 | L1280301 |
| UATR Diamond/KRS-5 ATR (Single Reflection) | L1250053 | | L1280304 |
| UATR Germanium ATR (Single Reflection) | L1250054 | | L1280305 |
| UATR Diamond/ZnSe ATR (3 Reflection) | L1250051 | | L1280302 |
| UATR Diamond/ZnSe ATR (9 Reflection) | L1250052 | | L1280303 |
| Liquid UATR Diamond/ZnSe (9 Reflection) | | | L1280069 |
| UATR Pressure Arm O-Ring id: 3 mm; 1.5 mm CS N70, PK/12 | L9004319 | L9004319 | L9004319 |

PerkinElmer HATR Accessory

PREMIUM

Available in Premium and Value versions this accessory is supplied with a top-plate fitted with a 25-reflection, 45 degree, 50 mm ZnSe crystal, allowing simple sampling of solids, films and powders.

| Description | Spectrum One/100/400/65 | Spectrum Two | Frontier |
|---|-------------------------|--------------|----------|
| Premium HATR with ZnSe Flat Top Plate | L1200311 | | L1280308 |
| Premium HATR with ZnSe Trough Top Plate | L1200312 | | L1280312 |
| Value HATR with ZnSe Flat Plate | | L1600113 | L1280321 |
| Value HATR with ZnSe Trough Plate | | L1600109 | L1280322 |

ATR Miracle Accessory (PIKE)

A single reflection HATR accessory designed for the analysis of highly absorbing solid, semi-liquid and liquid samples. The sampling plate configuration features a small round crystal allowing reliable analysis of small sample volumes.

| Description | Spectrum One/100/400/65 | Spectrum Two | Frontier |
|---|-------------------------|--------------|----------|
| Miracle Diamond ATR (Single Reflection) | | L1600114 | L1272483 |
| Miracle ZnSe ATR (Single Reflection) | L1272126 | L1600115 | L1272126 |
| Miracle Ge ATR (Single Reflection) | L1272127 | L1600116 | L1272127 |

Multiple (10) reflection HATR Accessory (PIKE)

Provides high sensitivity for analysis of low concentration components in liquid, solid, and polymer samples. Available with a selection of crystal materials and high temperature configurations.

| Description | Spectrum Two | Frontier Part No. |
|---|--------------|-------------------|
| Multiple (10) Reflection HATR with ZnSe flat and trough plate | L1272337 | L1272384 |

ATR Quest™

The Quest ATR Accessory is a single-reflection ATR accessory from Specac designed for laboratory spectroscopic sample analysis in the mid- and far-infrared. With innovative optical design and durable monolithic diamond ATR crystal option.

| Description | Frontier Part No. |
|---|-------------------|
| Quest ATR accessory with diamond top-plate | L1272503 |
| Quest ATR accessory with diamond (extended range) top-plate | L1272504 |
| Quest ATR accessory with ZnSe top-plate | L1272505 |
| Quest ATR accessory with Ge top-plate | L1272506 |

Additional Quest Top-Plates

| Description | Part No. |
|--|----------|
| Quest ATR Diamond Crystal top-plate | L1272511 |
| Quest ATR Diamond Extended Range Crystal top-plate | L1272512 |
| Quest ATR ZnSe Crystal top-plate | L1272513 |
| Quest ATR Ge Crystal top-plate | L1272514 |

Golden Gate™ ATR Accessory (Specac)

A high performance single reflection monolithic diamond ATR product offer, featuring a Type IIIA diamond ATR element metal-bonded into a tungsten carbide mount to provide outstanding durability and exceptional chemical resistance. The robust design allows this ATR accessory to be used to achieve high-quality spectral data in the analysis of a broad range of materials including those that are abrasive, hard, reactive, or corrosive.

| Description | Frontier |
|--|-----------------|
| Golden Gate™ Diamond ATR (Single Reflection) | L1272407 |

Gateway™ HATR Accessory (Specac)

An entry-level multi-reflection (6) horizontal ATR accessory. The rugged design and simple optical layout ensures optimum performance.

| Description | Spectrum Two | Frontier |
|--|-----------------|-----------------|
| Gateway™ HATR with ZnSe flat and trough top plates | L1272330 | L1272412 |
| Gateway™ HATR with ZnSe with electrical heating to 200 °C. Requires Gateway controller (territory dependent) | L1272414 | L1272414 |

25 Reflection ATR Accessory (Specac)

A vertically mounted ATR crystal accessory capable of being operated for a crystal incidence angle of between 30° to 60°. 25 Reflections are achieved at the 45° angle. The large number of reflections and range of incident angles makes this accessory ideally suited for the enhancement of small bands in weakly absorbing samples.

| Description | Spectrum Two | Frontier |
|--|-----------------|-----------------|
| 25 Reflection ATR Accessory with KRS-5 crystal | L1272372 | L1272372 |

The GladiATR Vision™ (PIKE)

A sampling tool which couples small area infrared analysis with simultaneous viewing. Samples are placed face down and positioned on the diamond crystal while its image is projected in real-time on the LCD screen. Analysis of thick or non-transparent samples is enhanced because viewing is through the diamond crystal. The 110X magnification of the sample image enables the positioning of small samples for optimized analysis.

| Description | Frontier |
|-------------------------------------|-----------------|
| GladiATR Vision/Video/PC connection | L1272381 |
| GladiATR Diamond | L1272423 |

The Variable Angle ATR (VATR) Accessory (PIKE)

This accessory has the ATR crystal mounted vertically and an optical layout is based on an optimized Gilby configuration and allows continuous adjustment of the incident beam angle between 30 to 60 degrees. Suitable for the analysis of solids, films and coatings. A unique mirror adjustment mechanism which utilizes mirror placement and proportional pivoting allows precise and repeatable alignment.

| Description | Frontier |
|--|-----------------|
| Classic VATR (25mm). Choose a 25mm crystal | L1272386 |
| Classic VATR(50mm). Choose a 50mm crystal | L1272443 |

| Crystal Type | 25mm Crystal | 50mm Crystal |
|--------------------------|-----------------|-----------------|
| KRS-5, 45° Parallelogram | L1272387 | L1272388 |
| KRS-5, 60° Parallelogram | L1272389 | L1272390 |
| ZnSe, 45° Parallelogram | L1272391 | L1272392 |
| ZnSe, 60° Parallelogram | L1272393 | L1272394 |
| Ge, 45° Parallelogram | L1272395 | L1272396 |
| Ge, 30° Parallelogram | L1272397 | L1272398 |
| Ge, 60° Parallelogram | L1272399 | L1272400 |
| Si, 45° Parallelogram | L1272401 | L1272402 |

PERKINELMER ATR TOP PLATE ACCESSORIES

PerkinElmer ATR Top Plates & Options

| Description | Part No. | Spectrum One/100/400/65 | Frontier |
|---|----------|-------------------------|----------|
| UATR Top Plate Diamond/ZnSe (1 Reflection) | L1250240 | ✓ | ✓ |
| UATR Top Plate Diamond/ZnSe (3 Reflection) | L1250241 | ✓ | ✓ |
| UATR Top Plate Diamond/ZnSe (9 Reflection) | L1250242 | ✓ | ✓ |
| UATR Top Plate Diamond/KRS5 (1 Reflection) | L1250046 | ✓ | ✓ |
| UATR Top Plate Ge (1 Reflection) | L1250048 | ✓ | ✓ |
| UATR 3.0mm Sample Position Plate (for 1 and 3 reflection UATR's) | L1202023 | ✓ | ✓ |
| UATR 7.0mm Sample Position Plate (for 1 and 3 reflection UATR's) | L1202024 | ✓ | ✓ |
| UATR Polarization Accessory Diamond/ZnSe (1 Reflection Top-Plate and Pressure Arm) | L1280064 | | ✓ |
| UATR Polarization Accessory Diamond/ZnSe (3 Reflection Top-Plate and Pressure Arm) | L1280065 | | ✓ |
| UATR Polarization Accessory Diamond/ZnSe (9 Reflection Top-Plate and Pressure Arm) | L1280066 | | ✓ |
| UATR Heated Top plate 60°C (Requires Pike Miracle ATR/10 Reflection HATR USB Temperature Controller) | L1272380 | | ✓ |
| UATR Heated Top plate 130°C (Requires Pike Miracle ATR/10 Reflection HATR USB Temperature Controller) | L1272433 | | ✓ |
| Universal 0.5mm ATR Shoe With 1.5mm diameter tip (for 1 and 3 reflection UATR's) | L1202049 | ✓ | ✓ |
| Universal 6.0mm ATR Shoe With 6.0mm flat end (for 1 and 3 reflection UATR's) | L1202050 | ✓ | ✓ |
| UATR Cone Shoe (for 1 and 3 reflection UATR's) | L1201980 | ✓ | ✓ |
| Premium HATR ZnSe 45 Degree Flat Plate | L1200313 | ✓ | ✓ |
| Premium HATR ZnSe 45 Degree Trough Plate | L1200314 | ✓ | ✓ |
| Premium HATR ZnSe 60 Degree Flat Plate | L1200315 | ✓ | ✓ |
| Premium HATR ZnSe 60 Degree Trough Plate | L1200316 | ✓ | ✓ |
| Premium HATR (Coated for extended lifetime) ZnSe 45 degree flat plate | L1200323 | ✓ | ✓ |
| Premium HATR (Coated for extended lifetime) ZnSe 45 degree trough plate | L1200324 | ✓ | ✓ |
| Premium HATR (Coated for extended lifetime) ZnSe 60 Degree Flat Plate | L1200325 | ✓ | ✓ |



| Description | Part No. | Spectrum One/100/400/65 | Frontier |
|---|----------|-------------------------|----------|
| Premium HATR Ge 30 Degree Flat Plate | L1200337 | ✓ | ✓ |
| Premium HATR Ge 30 Degree Trough Plate | L1200338 | ✓ | ✓ |
| Premium HATR Ge 45 Degree Flat Plate | L1200333 | ✓ | ✓ |
| Premium HATR Ge 45 Degree Trough Plate | L1200334 | ✓ | ✓ |
| Premium HATR Ge 60 Degree Flat Plate | L1200335 | ✓ | ✓ |
| Premium HATR Ge 60 Degree Trough Plate | L1200336 | ✓ | ✓ |
| Premium HATR AMTIR 45 Degree Flat Plate | L1200343 | ✓ | ✓ |
| Premium HATR AMTIR 45 Degree Trough Plate | L1200344 | ✓ | ✓ |
| Premium HATR AMTIR 60 Degree Flat Plate | L1200345 | ✓ | ✓ |
| Premium HATR AMTIR 60 Degree Trough Plate | L1200346 | ✓ | ✓ |
| Premium ATR Pressure Arm Kit | L1200321 | | ✓ |
| Premium Powder press | L1201944 | | ✓ |
| Premium Volatiles cover | L1205436 | | ✓ |

| Description | Part No. | Spectrum Two | Frontier |
|---------------------------------|----------|--------------|----------|
| Value HATR ZnSe Trough Plate | L1360266 | ✓ | ✓ |
| Value HATR ZnSe Flat Plate | L1360267 | ✓ | ✓ |
| Value HATR Ge Trough Plate | L1360268 | ✓ | ✓ |
| Value HATR Ge Flat Plate | L1360269 | ✓ | ✓ |
| Value HATR AMTIR-1 Trough Plate | L1360270 | ✓ | ✓ |
| Value HATR AMTIR-1 Flat Plate | L1360271 | ✓ | ✓ |
| Value HATR KRS-5 Trough Plate | L1360272 | ✓ | ✓ |
| Value HATR KRS-5 Flat Plate | L1360273 | ✓ | ✓ |
| Value HATR Clamp Assembly | L1360275 | ✓ | ✓ |

Pike ATR Top Plates & Options

| Description | Part No. | Spectrum One/100/400/65 | Spectrum Two | Frontier |
|--|----------|-------------------------|--------------|----------|
| Miracle ZnSe Top Plate | L1272130 | ✓ | ✓ | ✓ |
| Miracle Ge Top Plate | L1272131 | ✓ | ✓ | ✓ |
| Miracle Si Top Plate | L1272133 | ✓ | ✓ | ✓ |
| Miracle Diamond/ZnSe composite Top Plate | L1272313 | ✓ | ✓ | ✓ |
| Miracle Heated 60°C Diamond/ZnSe Crystal Plate* | L1272314 | | ✓ | ✓ |
| Miracle Heated ZnSe Crystal Plate* | L1272315 | | ✓ | ✓ |
| Miracle Heated 130°C Ge Crystal Plate* | L1272316 | | ✓ | ✓ |
| Miracle Volatiles Cover | L1272320 | ✓ | ✓ | ✓ |
| Miracle Liquid Retainer with Volatiles Cover | L1272321 | ✓ | ✓ | ✓ |
| Miracle Flat tip for high pressure clamp | L1272323 | ✓ | ✓ | ✓ |
| Miracle swivel tip for high pressure clamp | L1272324 | ✓ | ✓ | ✓ |
| Miracle Concave tip for high pressure clamp | L1272325 | ✓ | ✓ | ✓ |
| Multiple (10) Reflection HATR ZnSe Trough Plate | L1272338 | | ✓ | ✓ |
| Multiple (10) Reflection HATR ZnSe Flat Plate | L1272339 | | ✓ | ✓ |
| Multiple (10) Reflection HATR Ge Trough Plate | L1272340 | | ✓ | ✓ |
| Multiple (10) Reflection HATR Ge Flat Plate | L1272341 | | ✓ | ✓ |
| Multiple (10) Reflection HATR Heater with ZnSe Trough plate* | L1272342 | | ✓ | ✓ |
| GladiATR Heated ATR Diamond up to 210°C** | L1272422 | | | ✓ |
| GladiATR Ge Crystal Plate | L1272425 | | | ✓ |
| Miracle ATR/10 Reflection HATR USB Temperature Controller (220V, UK) | L1272317 | | ✓ | ✓ |
| Miracle ATR/10 Reflection HATR USB Temperature Controller (220V, Euro) | L1272318 | | ✓ | ✓ |
| Miracle ATR/10 Reflection HATR USB Temperature Controller (110V, 60Hz) | L1272319 | | ✓ | ✓ |
| GladiATR USB Temperature Controller (220V, UK) | L1272426 | | | ✓ |
| GladiATR USB Temperature Controller (220V, Euro) | L1272427 | | | ✓ |
| GladiATR USB Temperature Controller (110V, 60Hz) | L1272428 | | | ✓ |

* Requires L1272317, L1272318 or L1272319

** Requires L1272426, L1272427 or L1272428

Specac ATR Top Plates & Options

| Description | Part No. | Spectrum One/100/400/65 | Spectrum Two | Frontier |
|---|----------|-------------------------|--------------|----------|
| Silver Gate™ ZnSe Flat Top Plate (Single Reflection) | L1272274 | ✓ | ✓ | ✓ |
| Silver Gate™ ZnSe Recessed Top Plate (Single Reflection) | L1272276 | ✓ | ✓ | ✓ |
| Silver Gate™ Ge Flat Top Plate (Single Reflection) | L1272275 | ✓ | ✓ | ✓ |
| Silver Gate™ Ge Recessed Top Plate (Single Reflection) | L1272277 | ✓ | ✓ | ✓ |
| Gateway HATR ZnSe Electrically Heated Top Plate to 200°C (220V, UK) | L1272331 | | ✓ | |
| Gateway HATR ZnSe Electrically Heated Top Plate to 200°C (220V, Europe) | L1272373 | | ✓ | |
| Gateway HATR ZnSe Electrically Heated Top Plate to 200°C (110V, 60Hz) | L1272374 | | ✓ | |
| Gateway ZnSe 45 Degree Flat Top-Plate | L1272332 | | ✓ | ✓ |
| Gateway Ge 45 Degree Flat Top-Plate | L1272333 | | ✓ | ✓ |
| Gateway ZnSe 550µl Flow Through 45 Degree Top Plate | L1272334 | | ✓ | ✓ |
| Gateway ZnSe Thermocirculating 550µl flow through top plate | L1272335 | | ✓ | ✓ |
| Gateway ZnSe Water Heated/Cooled 45 Degree Top-plate | L1272336 | | ✓ | ✓ |
| Gateway™ UK Controller | L1272484 | | | ✓ |
| Gateway™ Euro Controller | L1272485 | | | ✓ |
| Gateway™ USA Controller | L1272486 | | | ✓ |
| Gateway™ China Controller | L1272487 | | | ✓ |

Diffuse Reflectance Accessories



PREMIUM

PerkinElmer Diffuse Reflectance Accessory

Available in Premium and Value versions this accessory provides a convenient and sensitive method for analyzing opaque or highly scattering solid samples such as pharmaceuticals, food products, soap powders, coal, clay, soil, paper, painted surfaces, polymer foam and catalysts. The accessory allows for macro or micro sampling and only requires insertion into the sample compartment to be ready to use.

| Description | Spectrum One/100/400/65 | Spectrum Two | Frontier |
|---------------------------------------|-------------------------|--------------|----------|
| Premium Diffuse Reflectance Accessory | | | L1280306 |
| Value Diffuse Reflectance Accessory | L1200351 | L1600111 | L1280323 |

EasyDiff Diffuse Reflectance Accessory (PIKE)

A reflectance accessory with pre-aligned optical components and micrometer controlled sample positioning for reproducible, high quality data.

| Description | Spectrum Two |
|--|--------------|
| EasyDiff Diffuse Reflectance Accessory | L1272344 |

DiffusIR™ Diffuse Reflectance Accessory (PIKE)

A research grade diffuse reflectance accessory with a large, efficient optical design accommodating optional environmental chambers for thermodynamic studies.

| Description | Frontier |
|--|----------|
| DiffusIR Diffuse Reflectance Accessory | L1272403 |

Selector™ Diffuse Reflectance Accessory (Specac)

For analysis of powdered and solid samples. An environmental chamber option allows enhanced vacuum, temperature and pressure studies.

| Description | Frontier |
|---|----------|
| Selector Diffuse Reflectance Accessory | L1272409 |
| Selector Diffuse Reflectance Accessory with Environmental Chamber | L1272410 |

Mid & NIR Integrating Spheres (PIKE)

Mid-IR and NIR sample compartment spheres for reflectance measurements. Samples are placed directly onto the sample port of the upward-looking sphere or over a thin infrared transmitting window. Measurement of diffuse transmission may also be done by placing the sample at the slide mount beam input port. Kits

include base optics, MCT detector (MIR) or InGaAs detector (NIR), and base mount.

| Description | Frontier |
|---|----------|
| Mid-IR Integrating Sphere with ZnSe Windows | L1272405 |
| NIR Integrating Sphere with KBr Windows | L1272406 |

Diffuse Reflectance Options

PerkinElmer Diffuse Reflectance Options

| Description | Part No. | Spectrum One/100/400/65 | Spectrum Two | Frontier |
|--|----------|-------------------------|--------------|----------|
| Diffuse Reflection Macrosample Cup | L1201654 | ✓ | ✓ | ✓ |
| Diffuse Reflection Microsample Cup | L1201655 | ✓ | ✓ | ✓ |
| Diffuse Reflection Multi-Purpose Sample Holder | L1201865 | ✓ | ✓ | ✓ |
| Diffuse Reflection Metal-Coated Silicon Carbide Abrasive Pads, Pack of 100 | L1275106 | ✓ | ✓ | ✓ |
| Diffuse Reflection Non-Coated Silicon Carbide Abrasive Sticks, Pack of 100 | L1271021 | ✓ | ✓ | ✓ |
| Diffuse Reflection Metal-Coated Diamond Abrasive Sticks, Pack of 100 | L1275105 | ✓ | ✓ | ✓ |
| Diffuse Reflection Non-Coated Diamond Abrasive Sticks, Pack of 100 | L1275102 | ✓ | ✓ | ✓ |

Pike Diffuse Reflectance Options

| Description | Part No. | Spectrum Two | Frontier |
|--|----------|--------------|----------|
| EasyDiff Small Sample Cup, 2 Per Package | L1272345 | ✓ | |
| EasyDiff Large Sample Cup, 2 Per Package | L1272346 | ✓ | |
| EasyDiff Sample Slide | L1272347 | ✓ | |
| EasyDiff Silicon Carbide Abrasive Disks, Pack of 100 | L1272348 | ✓ | |
| EasyDiff Diamond Abrasive Disks, Pack of 50 | L1272349 | ✓ | |
| EasyDiff Sample Cup Holder and Base | L1272350 | ✓ | |
| EasyDiff EasiPrep Sample Preparation Kit | L1272351 | ✓ | |
| EasyDiff Alignment Mirror | L1272352 | ✓ | |
| EasyDiff Abrasion Kit | L1272375 | ✓ | |
| DiffusIR Heating options. Requires DiffusIR Temperature Controller (territory dependent) | L1272344 | | ✓ |
| DiffusIR Environmental Chamber (900°C) | L1272458 | | ✓ |
| DiffusIR Environmental Chamber (500°C) | L1272459 | | ✓ |
| DiffusIR temperature controller for environmental chambers (220V, UK) | L1272461 | | ✓ |
| DiffusIR temperature controller for environmental chambers (220V, Euro) | L1272462 | | ✓ |
| DiffusIR temperature controller for environmental chambers (110V, 60Hz) | L1272463 | | ✓ |

Specular Reflectance Accessories

PerkinElmer Fixed Angle Specular Reflectance Accessory

This accessory allows measurements on samples with glassy coatings and reflective surfaces. The sample is mounted horizontally and can be measured using 2, 5 or 10mm apertures (included).

| Description | Spectrum One/100/400/65 | Spectrum Two | Frontier |
|--|-------------------------|-----------------|-----------------|
| Fixed Angle (16 degree) Specular Reflectance Accessory | 01860796 | L1600119 | 01860796 |

PerkinElmer Variable Angle Specular Reflectance Accessory

This accessory allows measurement of reflectance spectra at angles of incidence between 15 and 80 degrees. Provides high-quality, non-destructive routine measurements of glossy, non-scattering flat surfaces or coatings on highly reflective substrates. At high angles, very thin films or coating may be measured.

| Description | Frontier |
|---|-----------------|
| Variable Angle Specular Reflectance Accessory | 01860954 |

80Spec Grazing Angle Specular Reflectance Accessory (PIKE)

For the measurement of relatively thin films and mono-molecular layers. Samples are laid face down and the spectrum of the film is measured. Includes base optics, sample masks, polarizer mounts.

| Description | Spectrum One/100/400/65 | Spectrum Two | Frontier |
|---|-------------------------|-----------------|-----------------|
| 80Spec Grazing Angle Specular Reflectance Accessory | L1272248 | L1272248 | L1272248 |

10Spec™ Specular Reflectance Accessory (PIKE)

Recommended to measure the reflectivity of glass per ASTM Standard E1585-93. May also be used to measure near-normal reflectivity of a wide variety of surfaces including military devices, reflecting optics, anti-reflective (AR) coated surfaces, and other reflecting and non-reflecting materials.

| Description | Spectrum One/100/400/65 | Spectrum Two | Frontier |
|---------------------------------------|-------------------------|-----------------|-----------------|
| 10Spec Specular Reflectance Accessory | L1272247 | L1272361 | L1272247 |

VeeMAX™ II Variable Angle Accessory (PIKE)

Can be used as a specular reflectance or ATR accessory in both single and multiple reflection mode. The angle may be varied continuously from 30 to 80 degrees by the rotation of a single control. Has a built-in polarizer mount to permit selection of polarization angle without disturbing purge.

| Description | Spectrum One/100/400/65 | Frontier |
|--|-------------------------|-----------------|
| VeeMAX II Variable Angle Specular Reflectance Accessory | L1272240 | L1272240 |
| VeeMAX II Variable Angle Specular Reflectance ATR Accessory | | L1272382 |
| ATRMax II Variable HATR accessory with 45 degree ZnSe Trough Plate | | L1272383 |

Pike Specular Reflectance Options

| Description | Part No. | Spectrum One/100/400/65 | Spectrum Two | Frontier |
|---|-----------------|-------------------------|--------------|----------|
| 80Spec/VeeMAX KRS-5 Polarizer | L1272243 | ✓ | ✓ | ✓ |
| 80Spec ZnSe Manual Polarizer | L1272376 | ✓ | ✓ | ✓ |
| 80Spec/10Spec Gold Reflectance Mirror | L1272377 | ✓ | ✓ | ✓ |
| VeeMax ZnSe 45 degree flat plate | L1272450 | ✓ | | ✓ |
| VeeMax ZnSe 60 degree flat plate | L1272451 | ✓ | | ✓ |
| VeeMax Ge 45 degree flat plate | L1272452 | ✓ | | ✓ |
| VeeMax Ge 60 degree flat plate | L1272453 | ✓ | | ✓ |
| VeeMax Ge 65 degree flat plate | L1272454 | ✓ | | ✓ |
| ATRMax II Variable Angle Multiple reflection ATR, 45 deg ZnSe crystal | L1272455 | ✓ | | ✓ |
| ATRMax Ge 45 degree trough plate | L1272456 | ✓ | | ✓ |
| ATRMax Ge 45 degree flat plate | L1272457 | ✓ | | ✓ |

WIDE SELECTION OF SAMPLING CELLS AND WINDOW MATERIALS

PerkinElmer offers a versatile product line of liquid sampling cells which utilize a specially designed Universal mount suitable for both FT-IR and dispersive instruments, and a wide variety of high-quality window materials to meet your analytical needs. These windows are polished to precise tolerances of flatness.

The first criteria to consider when selecting a window material is the wavelength range over which the spectrum must be measured.

Other important considerations include solubility, reactivity, and the refractive index of the window material with respect to the sample. Sometimes mechanical and thermal characteristics may also be important.

Selecting Window Materials

The following information may be helpful in selecting window materials:

- **Sodium Chloride (NaCl)** is one of the most versatile window materials available, due to its spectral range and low cost. Samples should not contain water because NaCl is hygroscopic. This will cause the windows to fog and become unusable. Store NaCl cells in a desiccator when not in use. NaCl withstands mechanical stress and can be used up to 400 °C.
- **Potassium Bromide (KBr)** has a slightly wider spectral range than NaCl but is more hygroscopic. Although able to provide good resistance to mechanical shock, KBr is easily cleaved. KBr can be used up to 300 °C.
- **Calcium Fluoride (CaF₂)** is extremely hard and stable. CaF₂ is not significantly affected by moisture and does not fog. While resistant to most acids and bases, CaF₂ should not be used with ammonium salts.
- **Barium Fluoride (BaF₂)** is a relatively hard material, similar to CaF₂. Though less resistant to water than CaF₂, BaF₂ has a wider spectral range. The useful temperature range extends to 500 °C. Also, BaF₂ should not be used with ammonium salts.
- **Thallium Bromide-Iodide (KRS-5)** has a broad spectral range and a high refractive index, making it ideal for internal reflectance accessories. KRS-5 is slightly soluble in water and bases but insoluble in acids; KRS-5 is toxic and should not be repolished.
- **Silver Bromide (AgBr)** is easily scratched and has a tendency to cold flow at room temperature. Although only minimally degraded by water, AgBr will corrode after prolonged contact with moisture and metals. Avoid exposure to ultraviolet lights, as the crystal has a tendency to darken.
- **Zinc Selenide (Irtran-4™)** is similar to Cleartran except that it is somewhat softer and more easily scratched. Irtran-4 is used in total reflectance accessories because of its high refractive index.

| Window Material | Transmission Range μm | Transmission Range cm^{-1} | Refractive Index at 1,000 cm^{-1} | Solubility G/100 G H ₂ O at 20 °C |
|------------------------------------|----------------------------------|-------------------------------------|--|--|
| Sodium Chloride, NaCl | 0.25 – 16 | 40,000 – 625 | 1.49 | 36.0 |
| Potassium Bromide, KBr | 0.25 – 26 | 40,000 – 385 | 1.52 | 65.2 |
| Potassium Chloride, KCl | 0.25 – 20 | 40,000 – 500 | 1.46 | 34.7 |
| Cesium Iodide, CsI | 0.30 – 50 | 33,000 – 200 | 1.74 | 160.0 (at 61 °C) |
| Fused Silica, SiO ₂ | 0.20 – 4 | 50,000 – 2,500 | 1.42 (at 3,333 cm^{-1}) | Insoluble |
| Calcium Fluoride, CaF ₂ | 0.20 – 9 | 50,000 – 1,100 | 1.39 (at 2,000 cm^{-1}) | 1.51 x 10 ³ |
| Barium Fluoride, BaF ₂ | 0.20 – 13 | 50,000 – 770 | 1.42 | 0.12 (at 25 °C) |
| Thallium Bromide-Iodide, KRS-5 | 0.60 – 40 | 16,600 – 250 | 2.37 | < 4.76 x 10 ⁻² |
| Silver Bromide, AgBr | 0.50 – 35 | 20,000 – 285 | 2.00 | 12 x 10 ⁻⁶ |
| Zinc Sulfide, ZnS (Cleartran) | 1.0 – 14 | 10,000 – 715 | 2.20 | Insoluble |
| Zinc Selenide, ZnSe (Irtran-4) | 1.0 – 19.5 | 10,000 – 515 | 2.41 | Insoluble |
| Polyethylene (high-density) | 16 – 333 | 625 – 30 | 1.54 (at 5,000 cm^{-1}) | Insoluble |

Crystal Polishing Kit

Fogged windows are quickly restored with the infrared crystal polishing kit. The kit contains everything necessary to repolish sodium chloride, potassium bromide, or cesium iodide windows, and includes a smoothing lap, polishing rouge, a sponge, an optical flat, a Selvyt cloth, and a booklet describing the repolishing technique.

| Description | Part No. |
|-----------------------|----------|
| Crystal Polishing Kit | 51001188 |

Replacement Parts for the Crystal Polishing Kit

| Description | Part No. |
|---------------------------|----------|
| Selvyt Cloth (pkg. 5) | 51001324 |
| Glass Grinding Lap | 51001325 |
| Optical Lap | 51001326 |
| Cleaning Sponge (pkg. 2) | 51001327 |
| Tin Polishing Rouge, 56 g | 51001328 |
| Polishing Lap Glass Plate | 51001329 |

Demountable Cells and Windows



FOR MULLS, CAPILLARY FILMS, CAST FILMS, AND VERY VISCOUS LIQUIDS

Circular windows are used to construct a demountable cell where the sample is placed on one window and the second window is pressed lightly on top of the first. Spacers of various thicknesses can be used to vary the cell pathlength.

Demountable Cell

| Description | Part No. |
|--------------------------------------|----------|
| Universal Demountable Cell | L1270986 |
| 1 Window Aligner | 04821132 |
| 2 Neoprene™ Gasket | L1270512 |
| 3 Circular Window (see below) | |
| 4 Spacer (see below) | |
| 5 PTFE Plugs (pkg. 6) | 04821008 |
| 6 Quick Release Nut | 04821131 |

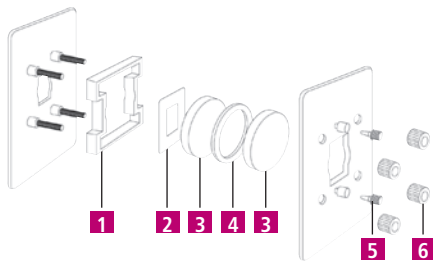

Semi-demountable Cells and Windows

FOR HIGH-VISCOSITY LIQUIDS OR MULL SAMPLES

By using rectangular windows instead of circular windows, the demountable cell becomes a semi-demountable cell. The semi-demountable cell can be used either as a demountable cell or as a sealed cell for high-viscosity liquids or mull samples. To order a semi-demountable cell, order the Universal Demountable Cell (L1270986) and your choice of semi-demountable windows and spacers.

| Description | Part No. |
|---------------------------------------|----------|
| 1 Window Aligner | 04821132 |
| 2 Neoprene™ Gasket | L1270512 |
| 3 Undrilled Window (see below) | |
| 4 Spacer (see below) | |
| 5 Drilled Window (see below) | |
| 6 PTFE Plugs (pkg. 6) | 04821008 |
| 7 Quick Release Nut | 04821131 |

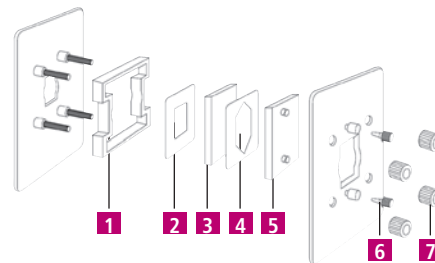

Circular Demountable Cell Windows (Pair)

| Window Material | Diameter | Thickness | Part No. |
|-------------------------|----------|-----------|----------|
| Sodium Chloride | 25 mm | 4 mm | L1271102 |
| Potassium Bromide | 25 mm | 4 mm | L1271202 |
| Calcium Fluoride | 25 mm | 4 mm | L1271602 |
| Barium Fluoride | 25 mm | 4 mm | L1272002 |
| Thallium Bromide-Iodide | 25 mm | 4 mm | L1270665 |
| Silver Bromide | 25 mm | 2 mm | L1272102 |
| Zinc Selenide | 25 mm | 2 mm | L1270766 |

Rectangular Semi-demountable Cell Windows (1 drilled; 1 undrilled)

| Window Material | Thickness | Part No. |
|-------------------------|-----------|----------|
| Sodium Chloride | 4 mm | L1271191 |
| Potassium Bromide | 4 mm | L1271192 |
| Calcium Fluoride | 4 mm | L1271193 |
| Barium Fluoride | 4 mm | L1271194 |
| Cesium Iodide | 4 mm | L1271195 |
| Zinc Selenide | 2 mm | L1270765 |
| Silver Bromide | 2 mm | L1270666 |
| Thallium Bromide-Iodide | 2 mm | L1270664 |

Circular Spacers

| Spacer Material | Thickness | Qty. | Part No. |
|-----------------|-----------|------|----------|
| Lead | 0.025 mm | 10 | L1271250 |
| PTFE* | 0.05 mm | 10 | 51001135 |
| PTFE* | 0.1 mm | 6 | 51001137 |
| PTFE* | 0.2 mm | 3 | 51001140 |
| PTFE* | 0.5 mm | 3 | 51001141 |

* PTFE spacers can be used for the analysis of less viscous samples.

Rectangular Spacers

| Spacer Material | Thickness | Qty. | Part No. |
|----------------------|-----------|------|----------|
| Lead | 0.025 mm | 10 | L1270301 |
| PTFE | 0.05 mm | 6 | L1270402 |
| PTFE | 0.1 mm | 6 | L1270404 |
| PTFE | 0.2 mm | 3 | L1270408 |
| PTFE | 0.5 mm | 3 | L1270409 |
| PTFE | 1 mm | 3 | L1270410 |
| Assorted (2 of each) | | | L1270421 |

Sealed Liquid Cells

FOR HIGHLY VOLATILE SAMPLES AND QUANTITATIVE ANALYSIS

The sealed liquid cells have a corrosion-resistant construction making them ideal for highly volatile samples. The sealed liquid cells are ideal for quantitative analysis where you require an accurate reproducible cell thickness. These cells use a lead spacer which is amalgamated to the window material. The resultant bond forms a good leak-free seal which is effective in preventing evaporation and loss of sample. The sealed liquid cell is an integral unit and cannot be disassembled.

The sample filling orifice is compatible with Luer-Lok™ hypodermic syringes. Two syringes are recommended when cleaning the cell. Never use viscous materials which are difficult to remove from a sealed liquid cell. Instead, use a semi-demountable cell.



Sealed Cell

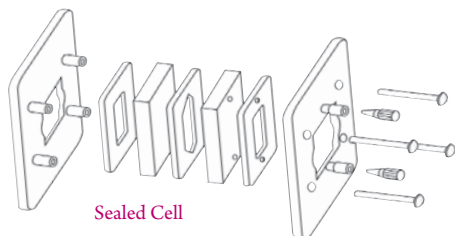

Sealed Cell

Rectangular Sealed Liquid Cells

| Window Material | Pathlength | Part No. |
|-------------------|------------|----------|
| Sodium Chloride | 0.025 mm | L1270941 |
| | 0.05 mm | L1270942 |
| | 0.1 mm | L1270944 |
| | 0.2 mm | L1270947 |
| | 0.5 mm | L1270948 |
| | 1 mm | L1270949 |
| Potassium Bromide | 0.025 mm | L1270951 |
| | 0.05 mm | L1270952 |
| | 0.1 mm | L1270954 |
| | 0.2 mm | L1270957 |
| | 0.5 mm | L1270958 |
| | 1 mm | L1270959 |
| Calcium Fluoride | 0.025 mm | L1270961 |
| | 0.05 mm | L1270962 |
| | 0.1 mm | L1270964 |
| | 0.2 mm | L1270967 |
| | 0.5 mm | L1270968 |
| | 0.1 mm | L1270969 |
| Zinc Selenide | 0.1 mm | L1270970 |

| Description | Part No. |
|--|----------|
| Luer-Lok Syringe for Sealed Liquid Cells | 04967845 |

Press-N-Lock Demountable Cell and Windows

FOR SIMPLE ANALYSIS OF MULLS, SMEARS, AND VISCOUS FILMS

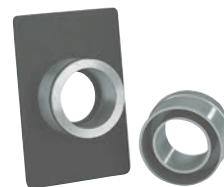

The Press-N-Lock Demountable Cell lets you analyze mulls, smears, viscous films, etc., without the use of nuts, springs, or bolts to keep the cell together. You can use this cell on any PerkinElmer FT-IR spectrometer. The cell consists of a backplate with a Viton™ O-Ring that lets you slip the cover on and off with ease.

| Description | Part No. |
|-------------------------------|----------|
| Press-N-Lock Demountable Cell | N9302642 |
| O-Rings 25 mm (pkg. 12). | N9302643 |

Press-N-Lock Demountable Cell Windows (Pair)

| Window Material | Diameter | Thickness | Part No. |
|------------------|----------|-----------|----------|
| NaCl | 25 mm | 4 mm | L1271102 |
| KBr | 25 mm | 4 mm | L1271202 |
| BaF ₂ | 25 mm | 4 mm | L1272002 |
| ZnSe | 25 mm | 2 mm | L1270766 |
| CaF ₂ | 25 mm | 4 mm | L1271602 |

FT-NIR Liquid Cells and Holders

A comprehensive range of FT-NIR cells are available for use with PerkinElmer FT-NIR's and can be found in the cells listing included in the UV section of this catalog.

| Description | Lightpath | Part No. |
|-------------------------|-----------|----------|
| Cylindrical cell holder | 10 mm | L1181303 |
| Cylindrical cell holder | 50 mm | N9302620 |
| Cylindrical cell holder | 100 mm | N9302640 |
| Rectangular cell holder | 50 mm | 02200550 |

Beam Condenser

Baseplate mounted for high performance transmission measurements of microsamples and gemstones. Horizontal sample platform for easy sample placement. Compatible with diamond anvil cell accessory. Includes a range of sample apertures 0.5 mm – 2.5 mm, and alignment tool.

| Description | Part No. |
|-----------------------------|----------|
| Spectrum Two Beam Condenser | L1600130 |

Short path demountable gas cells

Used to monitor air pollutants, study vapor phase transitions in gas molecules and quantify impurities in gas samples. The Pyrex cells are supplied with a choice of windows. Please note that all require the Universal 10 cm gas cell mount for use.

| Description | Spectrum One/100/400/65 | Spectrum Two | Frontier |
|---|-------------------------|--------------|----------|
| 10cm Short-path Demountable Gas Cells with NaCl Windows | 51000634 | 51000634 | 51000634 |
| 10cm Short-path Demountable Gas Cells with KBr Windows | 51000636 | 51000636 | 51000636 |
| 10cm Short-path Demountable Gas Cells with CaF ₂ Windows | 51000638 | 51000638 | 51000638 |
| Universal 10cm Gas Cell Mount | 51000817 | 51000817 | 51000817 |

DC-2 Diamond Compression Cell

Enables samples to be compressed to an ideal thickness for transmission experiments on an FTIR microscope stage or the Microfocus Beam Condenser. It uses two type IIIa diamond windows, each mounted into a Hastelloy plate. Used in combination with the Microfocus Beam Condenser, a high performance 4x beam condenser. The simple two lens linear optical system ensures easy alignment and high throughput over a wide working wavelength range.

| Description | Spectrum One/100/400/65 | Spectrum Two | Frontier |
|--|-------------------------|--------------|----------|
| Microfocus Beam Condenser with ZnSe Lenses. Requires but does not include DC-2 Diamond Compression Cell | L1272283 | L1272354 | L1272283 |
| Microfocus Beam Condenser with KRS-5 Lenses. Requires but does not include DC-2 Diamond Compression Cell | L1272284 | | L1272284 |
| DC-2 Diamond Compression Cell | L1272282 | L1272355 | L1272355 |

Variable Temperature Cell

Used for the transmission study of solid or liquid samples at temperatures ranging from -190 °C to 250 °C for solids and -70°C to 250°C for liquids. Holder is supplied with NaCl external windows as standard.

| Description | Spectrum One/100/400/65 | Spectrum Two | Frontier |
|--|-------------------------|--------------|----------|
| Variable Temperature Cell (220V, UK) | L1272288 | L1272356 | L1272288 |
| Variable Temperature Cell (220V, Eur) | L1272289 | L1272357 | L1272289 |
| Variable Temperature Cell (110V, 60Hz) | L1272290 | L1272358 | L1272290 |

The Tornado™ series of fixed, long pathlength gas cells

Designed for measuring the infrared spectra of gases and vapors at ambient temperatures and pressures. A range of pathlengths is available.

| Description | Spectrum One/100/400/65 | Spectrum Two | Frontier |
|--|-------------------------|--------------|----------|
| Tornado™ T5 Gas Cell 5m FPL; glass body; KBr windows | L1272301 | L1272370 | L1272301 |
| Tornado™ T10 Gas Cell 10m FPL; glass body; KBr windows | L1272302 | | L1272302 |
| Tornado™ T20 Gas Cell 20m FPL; glass body; KBr windows | L1272303 | | L1272303 |

The Cyclone™ series of fixed and variable long pathlength gas cells

Designed for measuring the infrared spectra of gases and vapors at ambient temperatures and pressures. A range of pathlengths is available.

| Description | Spectrum One/100/400/65 | Frontier |
|--|-------------------------|----------|
| Cyclone™ C2 gas cell 0.5 to 2.5m; glass body; CaF ₂ windows | L1272470 | L1272470 |
| Cyclone™ C2 gas cell 0.5 to 2.5m; metal body; CaF ₂ windows | L1272471 | L1272471 |
| Cyclone™ C5 Gas Cell 1-8m VPL; glass body; CaF ₂ windows | L1272299 | L1272299 |
| Cyclone™ C5 Gas Cell 1-8m VPL; metal body; CaF ₂ windows | L1272300 | L1272300 |

TRANSMISSION ACCESSORIES

The Storm Short Pathlength (10cm) Gas Cell

Ideal for routine gas and vapor spectroscopic analysis. The cell has a fixed 10 cm pathlength, and is available in Pyrex™ and stainless steel.

| Description | Frontier Part No. |
|--|-------------------|
| Storm Gas cell (Pyrex) with NaCl windows | L1272472 |
| Storm Gas Cell (Pyrex) with KBr windows | L1272473 |
| Storm Gas Cell (stainless steel) with NaCl windows | L1272474 |
| Storm Gas Cell (stainless steel) with KBr windows | L1272475 |

The Oxford Instrument Optistat DN

A nitrogen reservoir cryostat providing a controlled low temperature exchange gas environment for samples. Designed to operate as an integral part of an optical measurement system.

| Description | Frontier Part No. |
|--|-------------------|
| MIR Optistat DN system (ZnSe windows) | L1272480 |
| NIR Optistat DN system (Sapphire windows) | L1272481 |
| FIR Optistat DN system (Polypropylene windows) | L1272482 |

The Gasera Photoacoustic PA301 FTIR accessory

For flexible, rapid analysis of solid, semi-solid, and liquid samples in any form without sample preparation. Specially recommended for black samples, in-depth sampling, no-sampling preparation, etc. Photoacoustic principle requires low FT-IR/NIR mirror velocity and PA301 is optimized for 2.5 kHz He-Ne laser modulation frequency (or less).

| Description | Frontier Part No. |
|-------------------------------|-------------------|
| Photoacoustic PA301 accessory | L1272440 |

Transmission Options

| Description | Part No. | Spectrum One/100/400/65 | Spectrum Two | Frontier |
|--|----------|-------------------------|--------------|----------|
| Sealed Liquid Cell for Variable Temperature Cell, KBr, 1.00mm pathlength | L1272292 | ✓ | ✓ | ✓ |
| Sealed Liquid Cell for Variable Temperature Cell, KBr, 0.50mm pathlength | L1272293 | ✓ | ✓ | ✓ |
| Sealed Liquid Cell for Variable Temperature Cell, KBr, 0.10mm pathlength | L1272294 | ✓ | ✓ | ✓ |
| Solids Holder for Variable Temperature Cell (Sample size 12 – 30mm diameter and 0.1 – 0.8mm thick) | L1272298 | ✓ | ✓ | ✓ |
| Variable Temperature Cell Holder Jacket KBr windows (pair) | L1272291 | ✓ | ✓ | ✓ |
| Variable Temperature Cell Holder Flow Fittings Kit | L1272359 | ✓ | ✓ | ✓ |
| Cyclone™ C5 Gas Cell Pressure Gauge | L1272307 | ✓ | ✓ | ✓ |
| Cyclone™ C2 Gas Cell Heating Jacket and controller (220V, UK). | L1272364 | | | ✓ |
| Cyclone™ C2 Gas Cell Heating Jacket and controller (220V, Europe) | L1272365 | | | ✓ |
| Cyclone™ C2 Gas Cell Heating Jacket and controller (110V, 60Hz) | L1272366 | | | ✓ |
| Cyclone™ C5 Gas Cell Heating Jacket and controller (220V, UK) | L1272367 | | | ✓ |
| Cyclone™ C5 Gas Cell Heating Jacket and controller (220V, Europe) | L1272368 | | | ✓ |
| Cyclone™ C5 Gas Cell Heating Jacket and controller (110V, 60Hz) | L1272369 | | | ✓ |
| Tornado/Cyclone™ Vacuum/Gas Inlet and Outlet Taps | L1272307 | | | ✓ |



15 Ton Hydraulic Press



13 mm Evacuatable Potassium Bromide Die

15 Ton Hydraulic KBr Press

This bench top easy-to-operate press allows creation of the highest quality KBr pellets. It is used with the Evacuatable KBr die to prepare high quality 13 mm pellets. Requires, but does not include the Evacuatable KBr Die (51001144), the KBr Pellet Holder (04810949), and the Adjustable Adapter (L1060351).

| Description | Part No. |
|----------------------------|----------|
| 15 Ton Hydraulic KBr Press | 51004599 |

Accessories for the 15 Ton Hydraulic KBr Press

| Description | Part No. |
|---|----------|
| Evacuatable KBr Die | 51001144 |
| Plunger for Evacuatable KBr Die | 51001152 |
| Set of upper and lower anvils for Evacuatable KBr Die | 04820519 |
| Set of O-rings for Evacuatable KBr Die | 04800514 |
| Perspex extractor ring | 04977042 |
| KBr Pellet Holder | 04810949 |
| Adjustable Adapter to mount KBr Pellet Holder | L1060351 |

2 Ton Hydraulic KBr Press

This portable KBr press is used to prepare high quality 7 mm KBr pellets. Requires but does not include the 7 mm pellet die and ring holder (L1272492) and 7 mm Disc holder with rectangular mount (L1272493)



| Description | Part No. |
|---------------------------|----------|
| 2 Ton Hydraulic KBr Press | L1272491 |

2 Ton Hydraulic KBr Press Accessories

| Description | Part No. |
|--|----------|
| 7 mm Pellet Die including pellet ring holder | L1272492 |
| 7 mm Spare Pellet Ring Holder (Qty. 2) | L1272494 |
| 7 mm Disc Holder with Rectangular Mount | L1272493 |

Evacuatable KBr Mini-press

The Mini-press is designed for those situations where you occasionally need to make KBr pellets. This is the simplest solid sample device and is ideal for student use, where very low cost is an important factor. Two highly polished bolts turn against each other in a steel cylinder. The pellet is formed right inside the cylinder which becomes the sample holder. Once formed, the pellet cannot be removed from the cylinder without being destroyed. The Mini-press requires, but does not include, the holder (51002593).

| Description | Part No. |
|---------------------------------------|----------|
| Evacuatable KBr Mini-Press | 51002592 |
| Holder for Evacuatable KBr Mini-Press | 51002593 |

KBr Pellet Quick Press

The Quick Press provides a fast and economical way to prepare good quality KBr pellets. Pellets with diameters of 1, 3 or 7 mm can be prepared, depending on the die sets used.

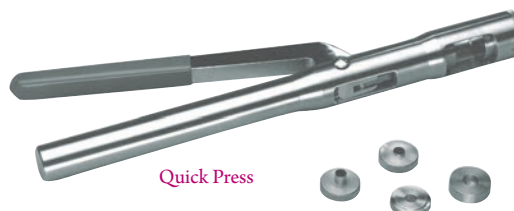

Quick Press

The Quick Press consists of a handpress, a 7 mm die set and a metal collar. Micropellets can be prepared in the Quick Press by purchasing the optional 1 or 3 mm die. The KBr pellet is formed in a metal collar that fits into a Pellet Holder (51002593; required, but not included).

| Description | Qty. | Part No. |
|-------------------------------|------|----------|
| Quick Press with Die | 7 mm | 01860436 |
| Optional Die | 1 mm | 01862295 |
| Optional Die | 3 mm | 01862292 |
| Spare Die | 7 mm | 01862289 |
| Pellet Holder for Quick Press | | 51002593 |

Support Rings For KBr Pellets

Circular paper rings to reinforce your KBr disks. If the amount of sample is limited there are also paper microframes which reduce the size of the pellet to 11 x 2 mm.

| Description | Qty. | Part No. |
|-------------|------|----------|
| Paper Rings | 100 | 51001148 |
| Microframes | 100 | 51001149 |

KBr Powder

| Description | Part No. |
|-------------------|----------|
| KBr Powder (100g) | 04977043 |

OilExpress Supplies

| Description | Part No. |
|--|----------|
| Insulation Block for Spectrum OilExpress | L1200558 |
| Sample Probe for Spectrum OilExpress | L1200555 |
| OilExpress Flowcell 0.1 mm pathlength, wedged Spacer, ZnSe Windows (one grooved), and two ports. | L1250220 |
| ZnSe Windows for Spectrum OilExpress Flowcell | L1191081 |
| Gaskets and Spacers for Spectrum OilExpress Flowcell | L1191082 |
| Autosampler Oil Bottle Rack, 30-position, 4 oz bottle | L1200551 |
| Autosampler Test Tube Rack, 16 x 6. For 17 x 100 mm tubes | L1200589 |
| 10 mL Syringe with Plunger for Spectrum OilExpress | L1200552 |
| Seal Kit for Spectrum OilExpress (4 piston noses) | L1200553 |
| Lubrication Kit for Syringe Pump Screw Drive for Spectrum OilExpress | L1200559 |
| Clamps to prevent Syringe barrel from moving. | L1200574 |

Tubing

| Description | Part No. |
|--|----------|
| Spectrum OilExpress Waste Tubing | L1200560 |
| Sample Needle Tubing for Spectrum OilExpress | L1200587 |
| Flowcell to Syringe Tubing for Spectrum OilExpress | L1200588 |
| Solvent to Syringe Tubing for Spectrum OilExpress (pkg. 2) | L1200556 |
| Injection/Transfer Port to Flowcell Tubing for Spectrum OilExpress | L1200557 |

Tubes and Bottles

| Description | Part No. |
|---|----------|
| 17 x 100 mm Polypropylene Tubes (15 ml), Pack of 1200 | N0777167 |
| Plug/Cap for 17 mm Tubes, Pack of 1200 | N0777599 |
| 13 x 100 mm Polypropylene Tubes, Pack of 1000 | B0508901 |
| 4 oz Clear Plastic Bottle with Lid (Safety Sealed), Case of 600 | N9308900 |
| 2 oz Clear Plastic Bottle with Lid (Safety Sealed), Case of 800 | N9308901 |

OilExpress 4 Supplies

Consumables

| Description | Part No. |
|--|----------|
| 17mm Sampling Convenience, Pack of 4800 | N9308904 |
| Wide Bore Oil Disposable Tips - pre-loaded 1000µL wide, Pack of 960 | L1610022 |
| Wide Bore Oil Disposable Tips, Pack of 4800 | L1610023 |
| 17mm OD x 100 mm Tall Tubes, Pack of 1200 | N0777167 |
| Plug/Cap for 17 mm OD Tubes, Pack of 1200 | N0777599 |
| 16mm OD x 67 mm Tall Tubes, Pack of 100 | L1191079 |
| 4 oz. Sample Bottle, Pack of 600 | N9308900 |
| 2 oz. Sample Bottle, Pack of 600 | N9308901 |
| Used Tip Disposable Drip Tray for OilExpress 4 and OilExpress 4 XL | L1610028 |
| Installation Test Oils Kit. Contains 1 x FT-IR In-Service Lubricants Control Oil (N9308350), 1 x OilExpress 4 120cS Test Oil (N9308351) & 1 x OilExpress 4 360cS Test Oil (N9308352) | N9300850 |
| FT-IR In-Service Lubricants Control Oil | N9308350 |
| System Liquid Additive, 100 mL | N9308354 |
| System Liquid Additive, 500 mL | N9308376 |
| System Liquid Detergent Additive, 1 Gallon | N9308380 |
| 120cS Test Oil, 500 mL | N9308351 |
| 360cS Test Oil, 100 mL | N9308352 |

| Description | Part No. |
|--------------------------|----------|
| 60 mL Trough, Pack of 25 | 6008103 |
| 60 mL Trough, Pack of 50 | 6008104 |

Spare Parts: Autosampler

| Description | Part No. |
|---|----------|
| Injection Station Tubing Kit | L1600350 |
| Injection Station | L1610021 |
| Hanging Tip Rack | 7607537 |
| VersaTip PLUS RoboRack Kit | 7002356 |
| System Liquid Filter Adapter Kit, kit includes - 4 x 40 micron filters (7005398), all necessary fittings and instructions to allow filters to be added to system liquid tubing | 7005397 |
| System Liquid Replacement Filter Kit, kit includes - 4 x 40micron filters for system liquid filters. Filters only. Assumes system liquid tubing has already been adapted using System Liquid Filter Adapter Kit (7005397) | 7005398 |
| 5.0 mL 4-tip Maintenance Kit, kit includes - four (4) syringes, four (4) valves, one (1) tubing replacement kit, and one (1) tube of syringe pump lubrication fluid | 7005386 |
| 80" x 30" Table, Fixed Height for OilExpress 4 and OilPrep 4, Table accommodates autosampler, FTIR, computer, monitor and keyboard | 5085685 |

Spare Parts: FT-IR Flow Cell

| Description | Part No. |
|---|-----------|
| ZnSe Flow Cell | L1272490 |
| ZnSe Flow Cell, Refurbished | L1272490R |
| ZnSe Cell Windows Kit, kit includes pair of ZnSe windows (front and back) | L1272496 |
| Flow Cell Gasket Set | L1272498 |
| Flow Cell Maintenance Kit - includes replacement ZnSe windows (L1272496) and cell gasket kit (L1272498) | L1272495 |

Spare Parts: FT-IR Instruments

| Description | Part No. |
|--|----------|
| Spectrum Two Source Replacement Kit | L1600243 |
| Spectrum Two Desiccant Replacement Kit | L1600244 |
| Spectrum Two ZnSe Window Replacement Kit | L1600242 |
| Spectrum Two KBr Window Replacement Kit | L1600241 |

Spectrum Two Portability Options

To allow for full portability the Spectrum Two portability pack (contains battery pack, car adaptor, Spectrum Two carry case and wireless router kit) should be ordered. Portability options may also be ordered individually.

| Description | Part No. |
|--|----------|
| Spectrum Two Portability Pack – includes UPS Battery Pack, Wireless Router and Spectrum Two Carry Case | L1600238 |
| Battery Pack – portable/UPS (req. country power cord and incl. 12V car adaptor) | L1600233 |
| Spectrum Two Carry Case | L9004199 |
| Spectrum Two UATR Carry Case | L9004200 |
| Spectrum Two Wireless Router Kit | L1600246 |
| 12V Car Adaptor | L9004128 |
| Wireless USB Key | L9004198 |



Disposable Desiccant Kit

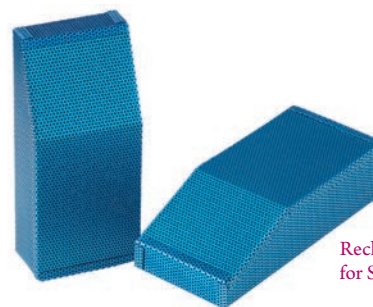

Rechargeable Desiccant Kit for Spectrum One/One NTS

Desiccant Kits

These kits are required for all the PerkinElmer FT-IR Spectrometers to keep the optical path free from moisture. It is recommended that the desiccant is replaced every six months. Follow the instructions in the appropriate instrument manual to install the desiccant.

Disposable Desiccant Kit

User-installable desiccant includes two desiccant packs. Four packs (two kits) required for each desiccant change. Six packs (three kits) required for use with Spectrum 65, Spectrum 100, Spectrum 100N and Spectrum 400.

| Description | Part No. |
|---|-----------------|
| For use with Model 1600, Paragon 500/1000, System 2000, Spectrum One/One NTS/400/1000/2000/BX/GX/RX/65/Frontier | N0171159 |
| For use with Spectrum Two | L1600244 |

Rechargeable Desiccant Kits

The desiccant is contained in rigid metal cages which are user-installable. Depending on the instrument either one or two cages are required.

| Description | Part No. |
|---|-----------------|
| For Spectrum Spectrum 65/100/100N/400/Frontier Includes: four (4) Desiccant Packs, two to be used in the instrument and two spares for recharging. | L1250311 |
| For Spectrum One/One NTS Includes: four (4) Desiccant Packs, two to be used in the instrument and two spares for recharging. | L1200219 |
| For Spectrum 1000/BX/RX, Model 1600, Paragon 500/1000 Includes: one (1) Desiccant Pack. One pack required for each desiccant change. | L1180480 |
| For Spectrum 400 Second Desiccant area Includes: one (1) Desiccant Pack. One required for each desiccant change. | L1251840 |

Replacement Laser Head Kit and Sources

| Description | Part No. |
|--|-----------------|
| Laser Head (HeNe) and Laser Power Supply User-installable spare for Spectrum One 65/100/400/Frontier and Spectrum One NTS/100N systems. | L1200253 |
| NIR Source Lamp for Spectrum One/65/100/400/Frontier | L1240098 |
| Mid-IR Source Assembly for Spectrum One/100/400/Frontier | L1200406 |
| Mid-IR Source Element for Spectrum One/65/100/400/Frontier | L1200443 |
| Spectrum Two Source Replacement Kit | L1600243 |

Instrument Performance Validation (IPV) Kits

Instrument Performance Validation Kits are available for both Mid-IR and Near-IR FT-IR instruments. All the kits include a polystyrene Traceable Reference Material (TRM) for abscissa calibration valid for three years. The Mid-IR IPV kits also include NG 11 Schott Glass Reference Material (RM) for checking the repeatability of ordinate measurement. Upgrade kits are available to replace the polystyrene TRM once the validity period has expired.

| Description | Part No. |
|--|-----------------|
| Mid Infrared IPV kit for Spectrum Software V.6 or lower | L1250404 |
| Mid Infrared IPV upgrade kit for Spectrum Software V.6 or lower | L1250474 |
| Mid Infrared IPV kit for Spectrum 10 Software | L1250404 |
| Mid Infrared IPV upgrade kit for Spectrum 10 Software | L1250474 |
| Near Infrared IPV kit for Spectrum Software V.6 or lower | L1180479 |
| Near Infrared IPV upgrade kit for Spectrum Software V.6 or lower | L1180490 |
| Near Infrared IPV kit for Spectrum 10 Software | L1250425 |
| Near Infrared IPV upgrade kit for Spectrum 10 Software | L1250475 |
| Polystyrene Test Film – 0.038 mm thickness (not traceable) | L1202057 |
| Methane Test Sample for Manual AVI | L1250462 |
| Spectralon Reference Material (for use with Remote Solid Sampling Systems) | L1241446 |

ATR IMAGING UPGRADE FOR SPOTLIGHT



ATR Imaging Upgrade for Spotlight Systems

Recommended option for the Spotlight 400 or 400N which allows convenient imaging of samples up to 10 mm thick. A large precision aligned crystal enables 400 μm areas to be collected to get more information from the sample quickly.

| Description | Qty | Part No. |
|-----------------------------|-----|-----------------|
| ATR Imaging Upgrade | | L1860319 |
| Spare Germanium Crystal | 1 | L1860317 |
| ATR Imaging Sample Supports | 10 | L1860318 |

Large Area ATR Imaging Accessory

Recommended option for the Spotlight 400 which allows convenient imaging of samples up to ca 8 mm thick. A large precision aligned crystal enables ca 1100 x 1100 micron areas to be collected to get more information from the sample quickly.

| Description | Qty | Part No. |
|----------------------------------|-----|-----------------|
| Large Area ATR Imaging Accessory | | L1860361 |

Micro ATR Objective Upgrade Kit

This kit upgrades Spotlight 400 and Microscope Systems without ATR Objective to include micro ATR facility. Includes an ATR Objective consisting of a cassegrain, mount and Germanium micro ATR crystal with holder. It covers the range 5,500 – 600 cm^{-1} . A spare Germanium crystal and holder is provided.

| Description | Part No. |
|---|-----------------|
| Micro ATR Objective Upgrade for Spotlight 400 Systems | L1860334 |
| Micro ATR Objective for AutoIMAGE Systems | L1860275 |
| Micro ATR Objective for Multiscope Systems | L1860298 |
| Optional/Spare Silicone Crystal with Holder | L1860269 |
| Spare Germanium Crystal with Holder | L1860268 |

Hot Stage Accessory

Consists of a heating block, which accepts FT-IR windows and a temperature controller. The Hot Stage can heat samples up to 230 $^{\circ}\text{C}$ in 1 $^{\circ}$ increments. The Hot Stage is held in the slide clip on the sample stage of a PerkinElmer FT-IR Microscope.

| Power Requirement | Part No. |
|----------------------------|-----------------|
| Hot Stage 100/120 V, 60 Hz | N1870184 |
| Hot Stage 220/240 V, 50 Hz | N1870188 |

Microsampling Tools

PerkinElmer offers a range of tools which allow you to prepare and manipulate samples for infrared microspectroscopy.

| Description | Part No. |
|-------------------------|-----------------|
| Microsampling Tool Kit | N1870151 |
| Includes: | |
| Dissecting Forceps | N9302610 |
| Roller Knife | N9302619 |
| Micro Specimen Tweezers | N9302609 |
| Straight Micro Probe | N9302605 |
| Aluminum Probe Handle | N9302622 |
| Pin Vise | N9302603 |

Microscope Supplies

| Description | Part No. |
|--|-----------------|
| Holder for 13 mm Sampling Disks | L1861634 |
| Holder for 13 mm Sampling Disks Includes gold mirror. | L1860409 |
| Base Microscope Slides Optical quality glass, 1 x 3 in., 1 mm thick for visible observations (box of 72). | N9302600 |
| Low-e Microscope Slides Optical quality with infrared reflective coating, 1 x 3 in., 1 mm thick for visible observations and infrared reflectance measurements (box of 25). | L1272249 |

Diamond Compression Cell

The cell consists of two Hastelloy plates containing a pair of diamond windows that enable samples to be compressed to an ideal thickness for transmission measurements.

| Description | Part No. |
|--------------------------|-----------------|
| Diamond Compression Cell | L1272282 |

Crystal Compression Cell

This is a device for flattening soft materials and holding specimens flat and in optical contact with salt windows. 1 and 2 mm thick windows of 13 mm outer diameter can be used with the cell. Two KBr windows (2 mm thickness) are included.

| Description | Part No. |
|--------------------------|-----------------|
| Crystal Compression Cell | N1870185 |

Infrared Windows

Infrared windows allow you to support microsamples for infrared analysis with the microscope.

| Window Material | Dimensions | Part No. |
|-------------------|------------|-----------------|
| Barium Fluoride | 13 x 1 mm | N9302611 |
| Barium Fluoride | 13 x 2 mm | N9302612 |
| Sodium Chloride | 13 x 2 mm | N9302614 |
| Potassium Bromide | 13 x 2 mm | N9302615 |

FT-IR Sampling Kits

Two FT-IR Sampling Kits are available to help the newcomer to FT-IR spectroscopy choose the more frequently required items, and to simplify ordering and storage. KBr has been chosen for the transmitting material. The two kits are packaged in attractive storage and carrying cases.



Liquid and Mull FT-IR Sampling Kit

This kit will satisfy the needs of most new users of FT-IR spectroscopy and has been designed to provide all the necessary equipment for handling liquids and mulls. Includes Polystyrene Film (0.038 mm), Nujol™ DD 057(100 mL), 10 cm Micro Spatula, 2mL Luer Syringe, Agate Pestle and Mortar, Magnetic Film Holder-Circular, Universal Demountable Cell Mount, Assorted Spacers, KBr Demountable Cell Windows (two pairs), and KBr Semi-demountable Cell Windows (two pairs).

| Description | Part No. |
|------------------------------------|-----------------|
| Liquid and Mull FT-IR Sampling Kit | L1365311 |



General Purpose FT-IR Sampling Kit

This kit includes all of the necessary equipment for handling liquids, mulls and KBr pellets. A laboratory press for making KBr pellets should be ordered. Includes Polystyrene Film (0.038 mm), Universal KBr Disk Holder, Nujol DD 057 (100 mL), 10 cm Micro Spatula, 2 mL Luer Syringe, Agate Pestle and Mortar, Magnetic Film Holder-Circular, KBr Powder (100 g), 13 mm KBr Die, Micro-disk Holder Accessory, Beam Condenser Accessory, 100µm Diameter Sample Holder Accessory, 500 µm Diameter Sample Holder Accessory, Universal Demountable Cell Mount, Assorted Spacers, KBr Demountable Cell Windows (two pairs), and KBr Semi-demountable Cell Windows (two pairs).

| Description | Part No. |
|------------------------------------|-----------------|
| General Purpose FT-IR Sampling Kit | L1365312 |

Spectrum Two Educational Starter Pack

A convenient kit which will teach you how to make solid and gas transmission measurements. Includes a simple KBr pellet press and pellet holder as well as a 10 cm gas cell and holder. Potassium Bromide not included.

| Description | Part No. |
|--------------------------------------|-----------------|
| Spectrum Two Educational Starter Kit | L1608022 |

FT-IR Introductory Kit

This kit contains samples to rapidly familiarize you with sampling techniques such as Transmission, ATR and Diffuse reflectance, and preparing a cast thin film. The kit also provides familiarization with IR software including Basic Operation, Quality Checks and Spectral processing (Search and Compare). The samples included and experiments rapidly demonstrate good sampling technique, sampling accessory selection, managing atmospheric interferences, signal-to-noise ratio, resolution selection and more.

| Description | Part No. |
|----------------------------------|-----------------|
| FT-IR Introductory Kit (1 User) | L1608001 |
| FT-IR Introductory Kit (5 Users) | L1608002 |

Solid/Liquid/Gas Sampling Starter Packs

| Description | Part No. |
|---|-----------------|
| KBr Disc Starter Pack Includes Adjustable Adaptor, KBr Die (13 mm) and KBr Pellet Holder. | L1272265 |
| KBr Disc Complete Starter Pack Includes Adjustable Adaptor, KBr Die (13 mm), KBr Pellet Holder, 15 ton press and KBr Powder (100 g). | L1272266 |
| Gas Sampling Starter Pack Includes 10 cm short-pathlength demountable gas cell, Spare KBr windows (47 mm diameter) and Universal gas cell mount. | L1272267 |
| Liquid Sampling Starter Pack Includes Universal Demountable Cell Mount, Circular KBr Windows (pair), Rectangular KBr Windows (pair), 0.1 mm Circular PTFE Spacers (contains 6) and Assorted Rectangular Spacers. | L1272268 |

FT-IR Sampling Kit Supplies

| Description | Size. | Part No. |
|-------------------------|-------------|-----------------|
| Nujol | 100 mL | 04960691 |
| Fluorolube | 1 oz bottle | 01862301 |
| KBr Powder | 100 g | 04977043 |
| KBr Random Cuttings | 100 g | N9300086 |
| Micro Spatula | 10 cm | 04967843 |
| Luer Syringe | 2 mL | 04967845 |
| Agate Pestle and Mortar | | 04967854 |

Application packs, described as resource packs or analysis packs depending on whether specific software/calibrations are included, help speed up application development and make your lab more efficient.

FT-IR Educational Resource Pack

For teaching FT-IR Spectroscopy to students and new users. Includes 15 experiments that can be used as part of a training curriculum.

| Description | Part No. |
|---------------------------------|-----------------|
| FT-IR Educational Resource Pack | L1608003 |

FT-IR Pharmacopeia Compliance Resource Pack

Designed to assist the user in understanding and achieving compliance to pharmacopeia regulatory requirements in FT-IR analysis, using PerkinElmer Spectrum 10 software and PerkinElmer FT-IR instruments. The pack covers the requirements of seven key Pharmacopoeias (USP, BP, EP, IP, JP, CP and IntPhr).

| Description | Part No. |
|---|-----------------|
| FT-IR Pharmacopeia Compliance Resource Pack | L1608004 |

FT-IR Nutraceutical Compliance Resource Pack

This pack facilitates IR spectroscopy analysis for Nutraceutical and Traditional Medicine professionals. The pack covers the requirements of seven key Pharmacopoeias (USP, BP, EP, IP, JP, CP and IntPhr). The quality assessment of most of natural products is supported by an included nutraceutical starter set of spectra.

| Description | Part No. |
|--|-----------------|
| FT-IR Nutraceutical Compliance Resource Pack | L1608005 |

FT-IR Polymer Resource Pack

Designed for use in the rapid screening and identification of polymer materials using FT-IR Spectroscopy. The pack is designed to help in the measurement of good quality spectrum of polymers, identification of polymers, and interpretation of polymer spectra. Utilization of library spectra is illustrated for effective results.

| Description | Part No. |
|-----------------------------|-----------------|
| FT-IR Polymer Resource Pack | L1608013 |

Environmental Hydrocarbons ASTM D7066-04 Application Pack

Contains accessories, consumables and application software to perform ASTM D7066-04 (extraction into hydrocarbon-free solvent and then transmission FT-IR). Includes cuvette holder, two Cuvette 10mm and Environmental Hydrocarbons Touch Application Software Kit.

| Description | Part No. |
|---|-----------------|
| Environmental Hydrocarbons ASTM D7066-04 Application Pack | L1608006 |

Environmental Hydrocarbons Cyclohexane Application Pack

Contains accessories, consumables and application software to perform oil in water measurements by extraction into cyclohexane then transmission FT-IR. Includes two Port Luer Lock %T Cell

- CaF2 0.5mm, two 2ml Luer lock Syringe, Spare 0.5mm PTFE Spacer (pk 6), IR Liquid Cell Luer Connected Waste Tube, and Environmental Hydrocarbons Touch Application Software Kit.

| Description | Part No. |
|---|-----------------|
| Environmental Hydrocarbons Cyclohexane Application Pack | L1608007 |

Environmental Hydrocarbons ATR Application Pack for Spectrum Two

Contains accessories, consumables and application software to perform oil in water measurements by ATR. Includes Spectrum Two HATR, ZnSe 45 deg Top plate – Flat, 25um micro pipette, pipette tips, and Environmental Hydrocarbons Touch Application Software Kit.

| Description | Part No. |
|--|-----------------|
| Environmental Hydrocarbons ATR Application Pack for Spectrum Two | L1608008 |

In-Service Lubricants Application Pack

Contains accessories, consumables and application software to perform used oil analysis. Includes flow cell with ZnSe windows, wedged spacer and luer fittings for Used Oil Analyzer, 3ml luer lock plastic syringe Starter Pk 100, Torque screwdriver, HEX BIT 3.0mm, IR Liquid Cell Luer Connected Waste Tube, PTFE plugs (pk 6) plugs, and In-Service Lubricants Touch Application Software Kit.

| Description | Part No. |
|--|-----------------|
| In-Service Lubricants Application Pack | L1608009 |

IR Biodiesel Application Pack

Contains accessories, consumables and application software to perform Biodiesel analysis using IR. Includes 2 Port Luer Lock %T Cell - BaF2 0.1mm, 2 x 2ml Luer lock Syringe, Assorted PTFE Spacers, Torque screwdriver, HEX BIT 3.0mm, IR Liquid Cell Luer Connected Waste Tube, and Fuels FT-IR Touch Application Software Kit. Does not support ASTM D7371.

| Description | Part No. |
|-------------------------------|-----------------|
| IR Biodiesel Application Pack | L1608010 |

IR Benzene in Gasoline ASTM D4053-04 Application Pack

Contains accessories, consumables and application software to measure Benzene in Gasoline by IR. Includes 2 Port Luer Lock %T Cell - KBr 0.05mm, 2 x 2ml Luer lock Syringe, Spare 0.05mm PTFE Spacer (pk 6), Torque screwdriver, HEX BIT 3.0mm, IR Liquid Cell Luer Connected Waste Tube, AVI Manual Kit, FT-IR Fuels Touch Application Software Kit.

| Description | Part No. |
|---|-----------------|
| IR Benzene in Gasoline ASTM D4053 – 04 Application Pack | L1608012 |

Transfat Application Pack

| Description | Part No. |
|----------------------------|-----------------|
| Trans-Fat Application Pack | L1608015 |

ENSURING SAFETY AND AUTHENTICITY WITH EVERY SAMPLE



PerkinElmer's consumables and accessories for DairyGuard™ are designed to keep your system running at peak performance while screening for potential economic adulterants in milk powder. In addition, these accessories are ideal when the application is extended to monitor for protein, moisture and fat levels.

Consumables

| Description | Part No. |
|---|-----------------|
| 90 mm Plastic Petri Dishes suitable for NIRA II 100 mm spinner, Pack of 600 | L9004575 |
| 55 mm Plastic Petri Dishes suitable for NIRA II 60 mm spinner, Pack of 1620 | L9004578 |
| 60 mm Soda Glass Petri Dishes suitable for NIRA II 60mm spinner, Pack of 10 | L9004574 |
| 100 mm Soda Glass Petri Dishes suitable for NIRA II 100mm spinner, Pack of 10 | L9004573 |
| 19 mm Glass Vials, 19 mm x 51 mm, Pack of 144 | L9004892 |

Spare Parts and Miscellaneous

| Description | Part No. |
|--|-----------------|
| Spare NIR source , monkey NIR Frontier and Dual MIR / NIR Frontier | L1242701 |
| Desiccant pack - Frontier, Spectrum 100 , Spectrum 400 | L0171159 |
| Barcode Reader, hand- held | L9004196 |
| Transflectance ICRA Liquids Sampler Kit - includes five Petri Dish Liquid Reflectors and bases, NIRA Liquids Sampling procedure and user guide | L1185153 |

Reflectance Standards

PerkinElmer offers a variety of Reflectance Standards to help ensure the system is running optimally for milk powder analysis. Choose from various combinations of calibrated or uncalibrated reflectance that deliver optimum screening results.

| Description | Part No. |
|--|-----------------|
| 99% Reflectance Polymer 60 mm, 8 mm x 58 mm, Uncalibrated | L1281920 |
| 99% Reflectance Polymer 100 mm, 8 mm x 98 mm, Uncalibrated | L1281921 |
| 99% Reflectance Standard 60 mm, 8 mm x 58 mm, Calibrated | L1281922 |
| 99% Reflectance Standard 100 mm, 8 mm x 98 mm, Calibrated | L1281923 |
| 50% Reflectance Standard 60 mm, 8 mm x 58 mm, Calibrated | L1281924 |
| 50% Reflectance Standard 100 mm, 8 mm x 98 mm, Calibrated | L1281925 |
| Reflectance Standards, 60 mm, 8 mm x 58 mm, Calibrated, set of 4 | L1281926 |
| Reflectance Standards, 100 mm, 8 mm x 98 mm, Calibrated, set of 4 | L1281927 |
| Reflectance Abscissa Standard 60mm, 8 mm x 58 mm, Calibrated | L1281928 |
| Reflectance Abscissa Standard 100mm, 8 mm x 98 mm, Calibrated | L1281929 |
| Reflectance Standard Recalibration Service, it is recommended that reflectance standards are re-calibrated after 12 months | L1281930 |

Sample Cups

Sample cups for DairyGuard™ system are 50 mm, black, round, metal with quartz glass base. These versatile cups can also be used to analyze dry, ground food or agriculture products. All cups use the same disposable backs for convenience.

| Description | Part No. |
|---|-----------------|
| 50 mm with Quartz Base | L1281931 |
| 50 mm with Quartz Base, Screw Back | L1281932 |
| 50 mm Camlock Cup with Quartz Powder Base | L1281933 |
| 50 mm with Disposable Backs | L1281934 |

DEUTERIUM AND TUNGSTEN SOURCE LAMPS

PerkinElmer's long-lifetime deuterium and tungsten source lamps provide the best wavelength coverage across the working range of the spectrometer for consistently high performance. All lamps are pre-aligned and can be easily changed by the user. Our extensive quality control and inspection process demands the very best quality sources to provide high sensitivity and stability for your key measurements.



Deuterium Lamp
Part No. L6022728

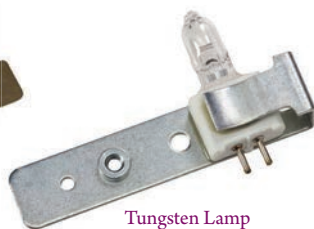

Tungsten Lamp
Part No. B0114620



Source Lamps for LAMBDA Spectrophotometers

Deuterium Lamps

| LAMBDA Model | Part No. |
|---|-----------------|
| For LAMBDA 2X/3X/4X/6XX/7XX/8XX/9XX/10XX* | L6022728 |

Tungsten Lamps

| LAMBDA Model | Part No. |
|---|-----------------|
| For LAMBDA 2X/3X/4X/6XX/7XX/8XX/9XX/10XX* | B0114620 |

*Prefocused and prealigned.

Calibration Reference Materials for PerkinElmer and non-PerkinElmer Spectrometers

PerkinElmer reference materials speed calibration verification of UV/Vis and UV/Vis/NIR spectrometers*, providing laboratory managers with the evidence they need to pass the strictest quality audit.



Photometric and Wavelength Accuracy Reference Material Set

A comprehensive range of certified traceable filters and sealed cuvettes fit into the standard 10mm cuvette holder of PerkinElmer and non-PerkinElmer instruments allowing users to generate simple protocols to verify ordinate and abscissa accuracy, stray light radiation, and spectral resolution. All reference materials are certified traceable to NIST primary reference materials and are supplied with a calibration certificate detailing the calibration method and results.

A central PerkinElmer recertification laboratory equipped with state-of-the-art instrument technology ensures a rapid turnaround service for periodic recalibration of PerkinElmer and non-PerkinElmer reference materials, allowing laboratories to maintain the requirements of their calibration SOP's.

Features and Benefits

- Comprehensive range of reference materials
- Traceable to NIST
- Immediate availability
- Rapid recertification service for PerkinElmer and non-PerkinElmer reference materials

*Not diode array spectrometers.

CALIBRATION AND RECERTIFICATION SOLUTIONS

Photometric and Wavelength Accuracy Reference Material Set

| Description | Part No. |
|--|-----------------|
| Photometric and Wavelength Accuracy Reference Material Set | B0507805 |

A set of reference materials used to verify the ordinate and abscissa (wavelength) accuracy of UV/Vis and UV/Vis/NIR Spectrometers. Neutral density glass filters included in this kit are ALZA ISO 17025 accredited.



The set includes four glass filters mounted in precision aluminum spring mounts. The cells are designed for use with standard 10 mm cuvette holders of most UV/Vis and UV/Vis/NIR Spectrometers. There are three neutral density glass filters for checking the ordinate accuracy and a holmium oxide glass filter for checking the wavelength accuracy of a spectrometer. Each filter has an identification number. The ordinate and abscissa values of each filter are quoted in the accompanying Certificate of Calibration, nominally 1A (10%T), 0.5A (30%T) and 0.3A (50%T). Reference materials are supplied in a re-useable UV-protective storage container.*

Stray Light Solutions Reference Material Set

| Description | Part No. |
|--|-----------------|
| Stray Light Solutions Reference Material Set | B2500099 |

Set of reference materials comprising four solutions in sealed cells — one reference solution and three test solutions. The cells are designed for use with standard 10 mm cuvette holders of most UV/Vis and UV/Vis/NIR Spectrometers. The test solutions, comprising sodium iodide, sodium nitride, and potassium chloride, act as a cut-off filter with a very precise wavelength. Reference materials are accompanied with a Certificate of calibration and are supplied in a re-useable UV-protective storage container.*

Pharmacopoeia Solutions Reference Material Set

| Description | Part No. |
|--|-----------------|
| Pharmacopoeia Solutions Reference Material Set | B2500100 |

* Since UV/Vis and UV/Vis/NIR reference materials require periodic recertification a rapid, convenient recertification program is available through PerkinElmer's central recertification laboratory.

Reference materials to verify calibration of UV/Vis and UV/Vis/NIR Spectrometers in accordance with Pharmacopoeia monographs, including:

- Ordinate (photometric) accuracy (potassium dichromate in perchloric acid)
- Abscissa (wavelength) accuracy (holmium perchlorate)
- Stray radiation level (potassium chloride)
- Resolution (toluene in hexane)

Set of reference materials comprising six solutions in sealed cells — two reference solutions and four test solutions. The cells are designed for use with standard 10mm cuvette holders of most UV/Vis and UV/Vis/NIR Spectrometers. Reference materials are accompanied with a Certificate of calibration and are supplied in a re-useable UV-protective storage container.

Reference Mirror for Reflectance Spectroscopy

| Description | Part No. |
|---|-----------------|
| Reference Mirror for Reflectance Spectroscopy | N1010504 |

This mirror is required to verify the specular reflectance calibration of PerkinElmer and Non-PerkinElmer reflectance accessories. The aluminum mirror with magnesium fluoride coating is a secondary standard and is calibrated according to GLP regulations in the wavelength range 250 to 2500 nm and includes spectral data on convenient transfer media for %RC reflection correction.

Recertification Program for UV/Vis Calibration Reference Materials

| Description | Part No. |
|--|-----------------|
| Recertification Program for UV/Vis Calibration Reference Materials | N1010539 |

To guarantee the integrity of your Reference Material set they must be recertified at periodic intervals. PerkinElmer offers a rapid service through our convenient central recertification laboratory in the USA. The recertification process includes as received analysis, inspection and cleaning of the reference material, recertification testing using state-of-the-art instrument technology, and certificate of the results. Fast shipment to and from our laboratory from anywhere in the world is free and we return your recertified standards in ten business days or less from the time we receive them.

Note: A recertification service for individual reference materials or non-PerkinElmer reference materials is also available. Please contact our recertification laboratory in the United States by phone (1-203-402-6852) or email (PKIFILTERS@PerkinElmer.com) for availability, pricing, requests, ordering procedures and other questions.

Diffuse Reflectance Standards

| Description | Part No. |
|--|------------------|
| 99% Diffuse Reflectance Standard, 2-inch, calibrated | PELA 9058 |
| 2%, 50%, 75%, 99% Diffuse Reflectance Standards Kit, 2-inch, calibrated | PELA 9011 |
| 2%, 5%, 10%, 20%, 40%, 60%, 80%, 99% Diffuse Reflectance Standards Kit, 2-inch, calibrated | PELA 9013 |
| Diffuse Reflectance Standards Kit, 2-inch, calibrated color: R, G, B and Y | PELA 9018 |
| Diffuse Reflectance Standards Kit, 2-inch, calibrated color: O, P, C, and V | PELA 9019 |
| Adjustable Prop | L6020329 |

HIGHEST QUALITY FOR EVERY APPLICATION

PerkinElmer Cells Ensure Top Optical Performance, with High Cell Transmission and Accurate Pathlength



No matter what type of cells your application requires — rectangular or cylindrical, standard or short path, micro, semi-micro or flowcells — choosing only high quality, precision cells allows you to make full use of the accuracy and sensitivity of your optical instrument.

The cell windows are fused to the bodies by a special process which avoids deformation of the windows. This assures that the full width of the cell is usable and the finished cell dimensions are maintained.

Our cells are manufactured from various types of glass. We offer three basic materials: Special Optical Glass, SUPRASIL® UV Quartz and SUPRASIL 300 NIR Quartz, in all the common sizes and types. The most important criterion for the choice of a particular type of glass is the spectral range for which the cell is intended. Color logos are fused onto each PerkinElmer cell, thus indicating the spectral range over which the cell can be used.

Special Optical Glass 320 nm - 2,500 nm

Indicates that SCHOTT type UK 5 is used for cells referred to in the catalog as manufactured from "Special Optical Glass". This crown glass is made from exceptionally pure raw materials, which gives an improved transmission in the near ultraviolet range. An empty cell will give a transmission of more than 80% over a spectral range of between 320 nm and 2,500 nm.

SUPRASIL UV Quartz 200 nm - 2,500 nm

Indicates that quartz of the highest purity and homogeneity has been used for the window. Because it is produced from a silicon compound, it is also called synthetic quartz. SUPRASIL gives transmission values of more than 80% over a spectral range of between 200 nm and 2,500 nm for an empty cell.

SUPRASIL 300 NIR Quartz 200 nm - 3,500 nm

Denotes a synthetic quartz that is free from OH absorption. Therefore it is suitable for applications in the near infrared range up to approximately 4,000 nm. SUPRASIL 300 gives a transmission of more than 80% over a spectral range of between 200 nm and 3,500 nm for an empty cell.

Macro Cells

Standard rectangular macro cells are the most frequently-used type of spectroscopy cell for routine liquids analysis. Each cell has a standard inside width of 9.5 mm and a base thickness of 1.5 mm.

Macro with PTFE Lid

| Lightpath | Outside Dim. H x W x D | Cell Volume | Qty. | Part No. |
|---|------------------------|-------------|------|-----------------|
| NIR Quartz SUPRASIL® 300 | | | | |
| 1 mm* | 45 x 12.5 x 3.5 mm | 350 µL | 2 | B0631013 |
| 5 mm | 45 x 12.5 x 7.5 mm | 1.75 mL | 2 | B0631014 |
| 10 mm | 45 x 12.5 x 12.5 mm | 3.5 mL | 2 | B0631015 |
| 20 mm | 45 x 12.5 x 22.5 mm | 7.0 mL | 2 | B0631016 |
| 50 mm | 45 x 12.5 x 52.5 mm | 17.5 mL | 1 | B0631017 |
| 100 mm | 45 x 12.5 x 102.5 mm | 35.0 mL | 1 | B0631018 |
| Optical Glass 360-2,500 nm without lid | | | | |
| 10 mm | 45 x 12.5 x 12.5 mm | 3.5 mL | 4 | B0631134 |
| Quartz SUPRASIL | | | | |
| 1 mm* | 45 x 12.5 x 3.5 mm | 350 µL | 2 | B0631007 |
| 5 mm | 45 x 12.5 x 7.5 mm | 1.75 mL | 2 | B0631008 |
| 10 mm | 45 x 12.5 x 12.5 mm | 3.5 mL | 2 | B0631009 |
| 20 mm | 45 x 12.5 x 22.5 mm | 7.0 mL | 2 | B0631010 |
| 50 mm | 45 x 12.5 x 52.5 mm | 17.5 mL | 1 | B0631011 |
| 100 mm | 45 x 12.5 x 102.5 mm | 35.0 mL | 1 | B0631012 |
| Special Optical Glass | | | | |
| 1 mm* | 45 x 12.5 x 3.5 mm | 350 µL | 2 | B0631001 |
| 5 mm | 45 x 12.5 x 7.5 mm | 1.75 mL | 2 | B0631002 |
| 10 mm | 45 x 12.5 x 12.5 mm | 3.5 mL | 2 | B0631003 |
| 20 mm | 45 x 12.5 x 22.5 mm | 7.0 mL | 2 | B0631004 |
| 50 mm | 45 x 12.5 x 52.5 mm | 17.5 mL | 1 | B0631005 |
| 100 mm | 45 x 12.5 x 102.5 mm | 35.0 mL | 1 | B0631006 |

*Glass lid.

Macro with PTFE Stopper

| Lightpath | Outside Dim. H x W x D | Cell Volume | Qty. | Part No. |
|--------------------------------|------------------------|-------------|------|-----------------|
| NIR Quartz SUPRASIL 300 | | | | |
| 1 mm | 52 x 12.5 x 3.5 mm | 350 µL | 2 | B0631031 |
| 5 mm | 46 x 12.5 x 7.5 mm | 1.75 mL | 2 | B0631032 |
| 10 mm | 46 x 12.5 x 12.5 mm | 3.5 mL | 2 | B0631033 |
| 20 mm | 46 x 12.5 x 22.5 mm | 7.0 mL | 2 | B0631034 |
| 50 mm | 46 x 12.5 x 52.5 mm | 17.5 mL | 1 | B0631035 |
| 100 mm | 46 x 12.5 x 102.5 mm | 35.0 mL | 1 | B0631036 |
| Quartz SUPRASIL | | | | |
| 1 mm | 52 x 12.5 x 3.5 mm | 350 µL | 2 | B0631025 |
| 5 mm | 46 x 12.5 x 7.5 mm | 1.75 mL | 2 | B0631026 |
| 10 mm | 46 x 12.5 x 12.5 mm | 3.5 mL | 2 | B0631027 |
| 20 mm | 46 x 12.5 x 22.5 mm | 7.0 mL | 2 | B0631028 |
| 50 mm | 46 x 12.5 x 52.5 mm | 17.5 mL | 1 | B0631029 |
| 100 mm | 46 x 12.5 x 102.5 mm | 35.0 mL | 1 | B0631030 |
| Special Optical Glass | | | | |
| 1 mm | 48 x 12.5 x 3.5 mm | 350 µL | 2 | B0631019 |
| 5 mm | 46 x 12.5 x 7.5 mm | 1.75 mL | 2 | B0631020 |
| 10 mm | 46 x 12.5 x 12.5 mm | 3.5 mL | 2 | B0631021 |
| 50 mm | 46 x 12.5 x 52.5 mm | 17.5 mL | 1 | B0631023 |

Semi-micro Cells

Semi-micro cells have the same outside dimension as the Macro cells but the cell walls have been thickened slightly, limiting the interior sample chamber width to 4 mm. Each cell has a base thickness of 3.2 mm and each package contains two cells.



Semi-micro with PTFE Lid – Black Sides

| Lightpath | Outside Dim. H x W x D | Cell Volume | Part No. |
|--------------------------------|------------------------|-------------|-----------------|
| NIR Quartz SUPRASIL 300 | | | |
| 10 mm | 45 x 12.5 x 12.5 mm | 1.4 mL | B0631051 |
| Quartz SUPRASIL | | | |
| 5 mm | 45 x 12.5 x 7.5 mm | 700 µL | B0631048 |
| 10 mm | 45 x 12.5 x 12.5 mm | 1.4 mL | B0631049 |
| Special Optical Glass | | | |
| 5 mm | 45 x 12.5 x 7.5 mm | 700 µL | B0631046 |
| 10 mm | 45 x 12.5 x 12.5 mm | 1.4 mL | B0631047 |

Semi-micro with PTFE Lid – Clear Sides

| Lightpath | Outside Dim. H x W x D | Cell Volume | Part No. |
|--------------------------------|------------------------|-------------|-----------------|
| NIR Quartz SUPRASIL 300 | | | |
| 20 mm | 45 x 12.5 x 22.5 mm | 2.8 mL | B0631045 |
| Quartz SUPRASIL | | | |
| 20 mm | 45 x 12.5 x 22.5 mm | 2.8 mL | B0631042 |
| Special Optical Glass | | | |
| 20 mm | 45 x 12.5 x 22.5 mm | 2.8 mL | B0631039 |

Semi-micro with PTFE Stopper – Black Sides

| Lightpath | Outside Dim. H x W x D | Cell Volume | Part No. |
|---------------------------------|------------------------|-------------|-----------------|
| NIR Quartz SUPRASIL® 300 | | | |
| 5 mm | 46 x 12.5 x 7.5 mm | 700 µL | B0631065 |
| 10 mm | 46 x 12.5 x 12.5 mm | 1.4 mL | B0631066 |
| Quartz SUPRASIL | | | |
| 10 mm | 46 x 12.5 x 12.5 mm | 1.4 mL | B0631064 |

Semi-micro with PTFE Stopper – Clear Sides

| Lightpath | Outside Dim. H x W x D | Cell Volume | Part No. |
|--------------------------------|------------------------|-------------|-----------------|
| NIR Quartz SUPRASIL 300 | | | |
| 20 mm | 46 x 12.5 x 22.5 mm | 2.8 mL | B0631060 |
| Quartz SUPRASIL | | | |
| 20 mm | 46 x 12.5 x 22.5 mm | 2.8 mL | B0631057 |

Micro Cells

Micro cells have the same outside dimension as the Macro cells but the cell walls have been thickened, limiting the interior sample chamber width to 2 mm. Each cell has a standard light path of 10 mm and each package contains two cells.



Micro with PTFE Lid - Black Sides

| Outside Dim. H x W x Dt | Base Thickness | Cell Volume | Part No. |
|------------------------------|----------------|-------------|-----------------|
| Quartz SUPRASIL® | | | |
| 45 x 12.5 x 12.5 mm | 3.2 mm | 700 µL | B0631071 |
| Special Optical Glass | | | |
| 45 x 12.5 x 12.5 mm | 3.2 mm | 700 µL | B0631070 |

Micro with PTFE Stopper - Black Sides

| Outside Dim. H x W x Dt | Base Thickness | Cell Volume | Part No. |
|------------------------------|----------------|-------------|-----------------|
| Quartz SUPRASIL | | | |
| 40 x 12.5 x 12.5 mm | 1.5 mm | 400 µL | B0631077 |
| Special Optical Glass | | | |
| 40 x 12.5 x 12.5 mm | 1.5 mm | 400 µL | B0631076 |

Ultra-micro Cells

Ultra-micro cells use a narrower sample chamber, raising it directly into the center of the light path and masking it with black quartz. One cell with light path 40 x 12.5 x 12.5 mm.

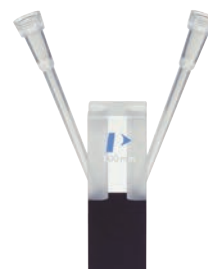

Ultra-micro with PTFE Lid

| Lightpath | Aperture | Chamber Volume | Part No. |
|------------------------|------------|----------------|-----------------|
| Quartz SUPRASIL | | | |
| 10 mm | 2 x 1.5 mm | 30 µL | B0631079 |

Ultra-micro with Pipette Tips

| Lightpath | Aperture | Chamber Volume | Part No. |
|------------------------|----------|----------------|-----------------|
| Quartz SUPRASIL | | | |
| 0.1 mm | 1 x 5 mm | 0.5 µL | B0631082 |
| 1 mm | 1 x 5 mm | 5 µL | B0631083 |
| 5 mm | ∅ 0.8 mm | 2.5 µL | B0631080 |
| 10 mm | ∅ 0.8 mm | 5 µL | B0631081 |

TrayCell™

The TrayCell is a fiber-optic ultra-micro measuring cell designed for the UV/Vis analysis of DNA/RNA and proteins. The dimensions of the TrayCell are equivalent to a standard cuvette in order to work in most spectrophotometers.



Features and Benefits

- Suitable for almost any current spectrophotometers
- Ideally suited for very small measurement volumes: 0.7 μL to 10 μL
- Trouble-free measurement of the sample at different optical path lengths simply by exchanging the cap [caps with dilution factors: 5, 10, 50 and 100]
- Fast and simple cleaning of the optics before measuring the next sample - the TrayCell remains in the cell holder!
- Samples can be reused after the measurement simply by pipetting them off
- During measurements, TrayCell shows excellent reproducibility

TrayCell™

| Description | Part No. |
|--|-----------------|
| UVS TrayCell complete with 0.2 mm and 1.0 mm caps. Complete with blocks to change beam height from 8.5 mm to 15 mm to 20 mm | L7110289 |
| 2.0 mm TrayCell, (Factor* 5) cap | L7110290 |
| 1.0 mm TrayCell, (Factor* 10) cap | L7110291 |
| 0.2 mm TrayCell, (Factor* 50) cap | L7110292 |
| 2 mm TrayCell, (Factor* 100) cap | L7110293 |

Caps for TrayCell™

| Description | Volume | Part No. |
|----------------------|-------------------------------------|-----------------|
| 1 mm (Factor* 10) | 3 μL - 5 μL | L7110291 |
| 0.2 mm (Factor* 50) | 0.7 μL - 4 μL | L7110292 |
| 2 mm (Factor* 5) | 6 μL - 10 μL | L7110290 |
| 0.1 mm (Factor* 100) | 0.7 μL - 3 μL | L7110293 |

* Factor = dilution factor compared to a standard cell with a path length of 10 mm

Cylindrical Cells – Macro with PTFE Stopper

Cylindrical cells are used with spectrophotometers that have a larger, circular light beam. Each cell has an outside diameter of 22 mm and an inside diameter of 19 mm. Each package contains one cell and two windows.

| Material | Lightpath | Outside Depth | Cell Volume | Remarks | Part No. |
|---------------------------------|-----------|---------------|-------------|------------------------|-----------------|
| NIR Quartz SUPRASIL® 300 | | | | | |
| | 10 mm | 12.5 mm | 2.8 mL | Neck Ø 6 mm Taper 1:10 | B0631099 |
| | 20 mm | 22.5 mm | 5.6 mL | Neck NS 7 | B0631100 |
| | 50 mm | 52.5 mm | 14.0 mL | 2 necks NS 7 | B0631101 |
| | 100 mm | 102.5 mm | 28.0 mL | 2 necks NS 7 | B0631102 |
| Quartz SUPRASIL | | | | | |
| | 10 mm | 12.5 mm | 2.8 mL | Neck Ø 6 mm Taper 1:10 | B0631095 |
| | 20 mm | 22.5 mm | 5.6 mL | Neck NS 7 | B0631096 |
| | 50 mm | 52.5 mm | 14.0 mL | 2 necks NS 7 | B0631097 |
| | 100 mm | 102.5 mm | 28.0 mL | 2 necks NS 7 | B0631098 |
| Special Optical Glass | | | | | |
| | 10 mm | 12.5 mm | 2.8 mL | Neck Ø 6 mm Taper 1:10 | B0631091 |
| | 20 mm | 22.5 mm | 5.6 mL | Neck NS 7 | B0631092 |
| | 50 mm | 52.5 mm | 14.0 mL | 2 necks NS 7 | B0631093 |
| | 100 mm | 102.5 mm | 28.0 mL | 2 necks NS 7 | B0631094 |



NIR Quartz SUPRASIL Cylindrical Cells Macro with PTFE Stopper, 10 mm **Part No. B0631099**

Flow-through Cells

Flow-through cells are used for measuring samples with continuous flow or with Sippers where individual samples are aspirated into the cell. All cells have center heights of 15 mm. Each package contains one cell with two clear windows. The cells listed below are Compact with two screw connectors, M6 x1 and 500 mm length FEP tubing - 1.9 mm o.d., 1.1 mm i.d.

| Material | Lightpath | Centre Height | Outside Depth | Aperture | Cell Volume | Part No. |
|------------------------|-----------|---------------|---------------------|---------------|-------------|-----------------|
| Quartz SUPRASIL | 1 mm | 15 mm | 35 x 12.5 x 12.5 mm | 17.5 x 3.5 mm | 62 µL | B0631085 |
| Quartz SUPRASIL | 10 mm | 15 mm | 35 x 12.5 x 12.5 mm | 11 x 3.5 mm | 390 µL | B0631084 |
| Quartz SUPRASIL | 10 mm | 15 mm | 35 x 12.5 x 12.5 mm | 8 x 2 mm | 160 µL | B0631087 |
| Quartz SUPRASIL | 10 mm | 15 mm | 35 x 12.5 x 12.5 mm | 11 x 2.5 mm | 300 µL | B0631150 |
| Quartz SUPRASIL | 10 mm | 15 mm | 35 x 12.5 x 12.5 mm | Ø 3 mm | 80 µL | B0631089 |
| Quartz SUPRASIL | 50 mm | 15 mm | 45 x 12.5 x 52.5 mm | Ø 3 mm | 370 µL | B0631088 |
| Quartz SUPRASIL | 10 mm | 15 mm | 35 x 12.5 x 12.5 mm | Ø 2 mm | 30 µL | B0631090 |
| Quartz SUPRASIL (FIAS) | 10 mm | 15 mm | 35 x 12.5 x 12.5 mm | Ø 1.5 mm | 18 µL | B0631151 |
| Quartz SUPRASIL (FIAS) | 10 mm | 15 mm | 35 x 12.5 x 12.5 mm | Ø 1 mm | 8 µL | B0631152 |

Lids and Stoppers

| Description | Lightpath | Part No. |
|---|-----------|-----------------|
| PTFE Fitted Lid | 5 mm | B0631145 |
| PTFE Fitted Lid | 10 mm | B0631129 |
| PTFE Stopper with NS 7 Fitting | | B0631128 |
| PTFE Stopper with Fitting Ø 6, taper 1:10 | | B0631149 |

Replacement Tubing

| Description | Part No. |
|--|-----------------|
| FEP-Replacement Tubing with one short screw fitting, 500 mm long | B0631130 |
| FEP-Replacement Tubing with one long screw fitting, 500 mm long | B0631131 |
| Sipper Tubing to Cuvette (in) | B2500129 |
| Sipper Tubing to Cuvette (out) | B2500127 |

DISPOSABLE CELLS



Disposable cells greatly reduce the risk of contamination, remove the need for cleaning reagents and lower laboratory costs as compared to quartz or glass cells.

Disposable cells are available in polystyrene and polymethyl methacrylate either as macro or semi-micro cells. Additionally, disposable cells are available in a special UV transparent material in macro, semi-micro and micro cells. The useful spectral range for UV material is between 220 and 900 nm, for polymethyl methacrylate it is 300 and 900 nm and for polystyrene it is 340 and 900 nm.

Each cell has a standard light path of 10 mm and is suitable for any UV/vis Spectrophotometer which accommodates cells with a center height of 15 mm.

Color coded caps can be ordered for the micro UV transparent cells which allow samples to be stored down to -20 °C.

Macro Cells

| Description | Outside Dimensions | Cell Volume | Qty. | Part No. |
|-------------------------|---------------------|--------------|-------|-----------------|
| UV Material | 45 x 12.5 x 12.5 mm | 2.5 – 4.5 mL | 100 | L7110269 |
| Polystyrene | 45 x 12.5 x 12.5 mm | 2.5 – 4.5 mL | 1,000 | L7110271 |
| Polymethyl Methacrylate | 45 x 12.5 x 12.5 mm | 2.5 – 4.5 mL | 1,000 | L7110273 |



Micro Cells

| Description | Outside Dimensions | Cell Volume | Qty. | Part No. |
|-----------------------------------|---------------------|-------------|------|-----------------|
| UV Material | 45 x 12.5 x 12.5 mm | 70 – 550 µL | 100 | L7110260 |
| UV Material | 45 x 12.5 x 12.5 mm | 70 – 550 µL | 500 | L7110261 |
| UV Material Individually Wrapped* | 45 x 12.5 x 12.5 mm | 70 – 550 µL | 100 | L7110262 |
| Caps - Blue | | | 100 | L7110264 |
| Caps - Yellow | | | 100 | L7110265 |
| Caps - Green | | | 100 | L7110266 |
| Caps - Orange | | | 100 | L7110267 |

* Free of DNase, DNA and RNase



Semi-micro Cells

| Description | Outside Dimensions | Cell Volume | Qty. | Part No. |
|-------------------------|---------------------|--------------|-------|-----------------|
| UV Material | 45 x 12.5 x 12.5 mm | 1.5 – 3.0 mL | 100 | L7110268 |
| Polystyrene | 45 x 12.5 x 12.5 mm | 1.5 – 3.0 mL | 1,000 | L7110272 |
| Polymethyl Methacrylate | 45 x 12.5 x 12.5 mm | 1.5 – 3.0 mL | 1,000 | L7110274 |

Cell Rack

Also available is a cell rack for easy storage of samples. It is suitable for standard 10 mm light path cells and holds up to 16 cells in numbered positions to aid sample tracking. The cell rack can withstand temperatures up to 121 °C so it can be used in an Autoclave.

| Description | Qty. | Part No. |
|-----------------------------|------|-----------------|
| Cell Rack, 16 cell capacity | 1 | L7110275 |

To extend the range of samples that you can analyze, we offer a wide range of sample holders.

The rectangular and cylindrical long-path cell holders are ideal for sensitive measurements on dilute samples where the extra pathlength is important. For the chemist, the test-tube holder provides a convenient method of sampling in-situ without having to decant the sample into standard cells.

Finally, extend your measurement capabilities to include solid materials with the solid and variable-angle sample holders.

Solid Sample Holder

Minimum sample size 10 x 15 mm. Maximum sample thickness 5 mm.

| Description | Part No. |
|---------------------|----------|
| Solid Sample Holder | B0080822 |

Test Tube Holder

This holder accommodates test tubes from 11 to 17 mm diameter.

| Description | Part No. |
|------------------|----------|
| Test Tube Holder | B0500952 |

Variable Angle Sample Holder

0° to 60° for sample position for measurement in transmission of filter glasses and other transparent samples. Minimum sample size is 30 x 40 mm.

| Description | Part No. |
|------------------------------|----------|
| Variable Angle Sample Holder | B0152471 |



Test Tube Holder

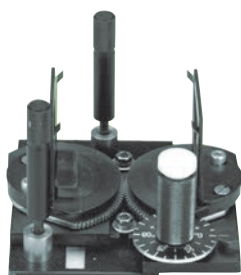

Variable Angle Sample Holder

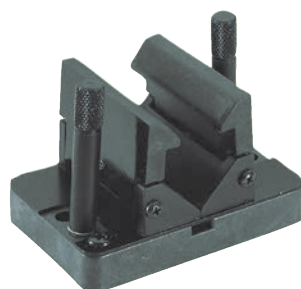

Cylindrical Long-path Cell Holder



Solid Sample Holder

MAXIMIZE SAMPLING FLEXIBILITY

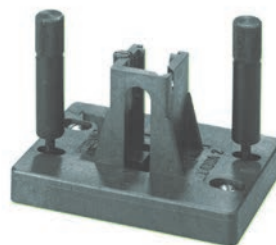

Standard Cell Holder

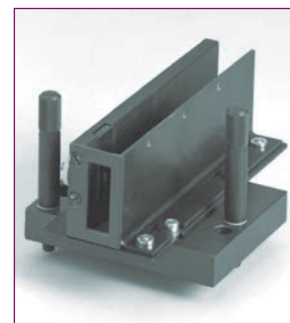

Rectangular Long-path Cell Holder

Standard Cell Holder

The Standard Cell Holder is provided as standard equipment with your PerkinElmer LAMBDA Series instrument. A lifter (included) makes short cell removal easy. It accommodates a large selection of rectangular cells up to 10 mm pathlength. The Standard Cell Holder is adjustable both vertically and horizontally.

| Description | Part No. |
|----------------------|----------|
| Standard Cell Holder | B0505071 |

Rectangular Long-path Cell Holder

The Rectangular Long-path Cell Holder accepts cells with pathlengths from 10 to 100 mm. This optional cell holder is easy to install and has the same footprint as the Standard Cell Holder. It is designed for a precise fit and gives you maximum reproducibility.

| Description | Part No. |
|---|----------|
| For LAMBDA 1X/2X/3X/4X/6XX/8XX/9XX/10XX/Bio | B0080821 |

Cylindrical Long-path Cell Holder

The Cylindrical Long-path Cell Holder accommodates cells with outside diameters from 22 to 30 mm. A versatile cell holder, it accepts cells with pathlengths up to 100 mm. The spring loaded clamping arms provide a precise, reproducible fit and are easy to adjust.

| Description | Part No. |
|-----------------------------------|----------|
| Cylindrical Long-path Cell Holder | C0550303 |

5+5 Cell Changer for LAMBDA 1X/2X/3X/4X/Bio

Automatic linear 5+5 cell changer for long pathlength cells up to 50 mm. Includes: Automatic Linear Transport (B2000186), Reference Kit (B2000310), and two Long Pathlength 5-Cell Holders (B0089439). No accessory PCB required.

| Description | Part No. |
|---|-----------------|
| 5+5 Cell Changer for LAMBDA 1X/2X/3X/4X/Bio | N1010569 |

8+1 Cell Changer for LAMBDA 1X/2X/3X/4X/Bio

Automatic water thermostatable linear cell changer for eight samples and one reference. Includes: Automatic Linear Transport (B2000186), 8-Cell Holder Water Thermostatable (B2205411), and Water Thermostatable Reference Cell Holder (B2000201). No accessory PCB required.

| Description | Part No. |
|---|-----------------|
| 8+1 Cell Changer for LAMBDA 1X/2X/3X/4X/Bio | N1010567 |

8+8 Cell Changer for LAMBDA 1X/2X/3X/4X/Bio

Automatic water thermostatable linear cell changer for eight samples and eight references. Includes: Automatic Linear Transport (B2000186), Reference Kit (B2000310), and two 8-Cell Holders (B2205411). No accessory PCB required.

| Description | Part No. |
|---|-----------------|
| 8+8 Cell Changer for LAMBDA 1X/2X/3X/4X/Bio | N1010568 |

13-Cell Changer System for LAMBDA 1X/2X/3X/4X/Bio

Includes cell changer and one carousel each for glass/quartz and plastic cuvettes. Accessory PCB (L6000500) required for LAMBDA 25/35/45, or PCB (B0509681) required for LAMBDA 10/20/40/Bio, but not included.

| Description | Part No. |
|---|-----------------|
| 13-Cell Changer System for LAMBDA 1X/2X/3X/4X/Bio | B0185210 |



8+1 Cell Changer Configuration

Automatic Linear Transport for LAMBDA 1X/2X/3X/4X/Bio

Automatic linear transport unit. Can be combined with 8-Cell Holder, Water Thermostatable (B2205411), Long Pathlength 5-Cell Holders (B0089439), or Research Peltier System (L6310011). For reference position, Reference Kit (B2000310) and 5- or 8-Cell Holder recommended, but not included. Water Thermostatable Reference Cell Holder (B2000201) can be used alternatively.

| Description | Part No. |
|---|-----------------|
| Automatic Linear Transport for LAMBDA 1X/2X/3X/4X/Bio | B2000186 |

Reference Kit

For Automatic Linear Transport (B2000186). For reference position to be used with 8-Cell Holder, Water Thermostatable (B2205411) or Long Pathlength 5-Cell Holder (B0089439).

| Description | Part No. |
|---------------|-----------------|
| Reference Kit | B2000310 |

Gel Cell, Glass

For gel measurements with Gel-Scanner Linear Transport (B2000199). Dimensions are 6 mm pathlength by 100 mm width by 10 mm height.

| Description | Part No. |
|-----------------|-----------------|
| Gel Cell, Glass | CP183700 |

FAST, EFFICIENT, TEMPERATURE-CONTROL



9 Cell w/ Reference Cell

Routine Peltier Systems

Routine Peltier System – Single Sample Accessory + Single Reference Accessory

Includes the Peltier Single Sample Accessory (B2000159) for the sample position and the Single Reference Accessory (B0510412) for the reference position. Also included are a reference position cover, power supply, power cables, and User's Guide. Selectable temperature range 20 °C to 45 °C. Requires the LAMBDA 25, 35, 45 Accessory Board (L6000500).

| LAMBDA Model | Part No. |
|-----------------|-----------------|
| 1X/2X/3X/4X/Bio | N1010565 |

Routine Peltier System – 9-Sample Position Accessory + Single Reference Accessory

Includes the Peltier 9-Sample Position Accessory for the sample position and the Single Reference Accessory for the reference position. Also included are 5 beam masks, alignment gauge, reference position cover, sample compartment extension, power supply, cables, and User's Guide. Selectable temperature range 20 °C to 45 °C. Must be service installed. Requires the LAMBDA 25, 35, 45 Accessory Board (L6000500).

| LAMBDA Model | Part No. |
|-----------------|-----------------|
| 1X/2X/3X/4X/Bio | N1010566 |

Routine Peltier Single Sample Accessory

Peltier temperature controlled single cell holder for the sample position. Also included are a reference position cover, power supply, power cables, and User's Guide. Selectable temperature range 20 °C to 45 °C. Requires the LAMBDA 25, 35, 45 Accessory Board (L6000500).

| LAMBDA Model | Part No. |
|-----------------|-----------------|
| 1X/2X/3X/4X/Bio | B2000159 |

Routine Peltier 9-Sample Position Accessory

Includes the Peltier 9 position cell changer, 5 beam masks, alignment gauge, reference position cover, sample compartment extension, power supply, power cables, and User's Guide. Must be service installed. Selectable temperature range 20 °C to 45 °C. Requires the LAMBDA 25, 35, 45 Accessory Board (L6000500).

| LAMBDA Model | Part No. |
|-----------------|-----------------|
| 1X/2X/3X/4X/Bio | B2000160 |

Routine Peltier Single Reference Accessory

Peltier temperature controlled single cell holder for the reference position. Also included are the power supply, power cables, and User's Guide. Selectable temperature range 20° to 45 °C. Requires the LAMBDA 25, 35, 45 Accessory Board (L6000500).

| LAMBDA Model | Part No. |
|-----------------|-----------------|
| 1X/2X/3X/4X/Bio | B0510412 |

9-Position Cell Holder

As included with the Peltier 9-Sample Position Accessory. Additional interchangeable cell holder for use with the 9-position cell changer.

| LAMBDA Model | Part No. |
|-----------------|-----------------|
| 1X/2X/3X/4X/Bio | B0510366 |

Stirring Rods Set of 15 pieces for stirring in the cuvette.

For use with the Research Peltier System-6 Position (PTP-6) (L6310011), and 13-Cell Changer Systems (B0185210), and Magnetic Stirrer Accessory (B0507355 and B0510070).

| LAMBDA Model | Part No. |
|-----------------|-----------------|
| 1X/2X/3X/4X/Bio | B0187028 |

PTP-A Single-cell Air-cooled Peltier Accessory

The PTP-A Single-cell Peltier Accessory is air-cooled and does not require a source of cooling water, making it very convenient to use with minimal setup time. Temperature programs are set up, edited and stored from the front panel of the controller unit.

The PTP-A is ideal for protein and nucleic assays to 37 °C and for many studies of kinetics, thermodynamics and acid-base equilibria.

| Description | Part No. |
|---|----------|
| PTP-A Single-cell Air-cooled Peltier System | L6310014 |

Water-thermostatted Single-cell Holder

A single-cell holder with 3 mm fluid tubing connectors to enable fluid circulated temperature stabilization. Can be installed in the reference position with the PTP-1 and PTP-6 to allow the reference sample to be temperature controlled. Requires, but does not include, a fluid circulator.

| Description | Part No. |
|--|----------|
| Water-thermostatted Single-cell Holder | B0080819 |

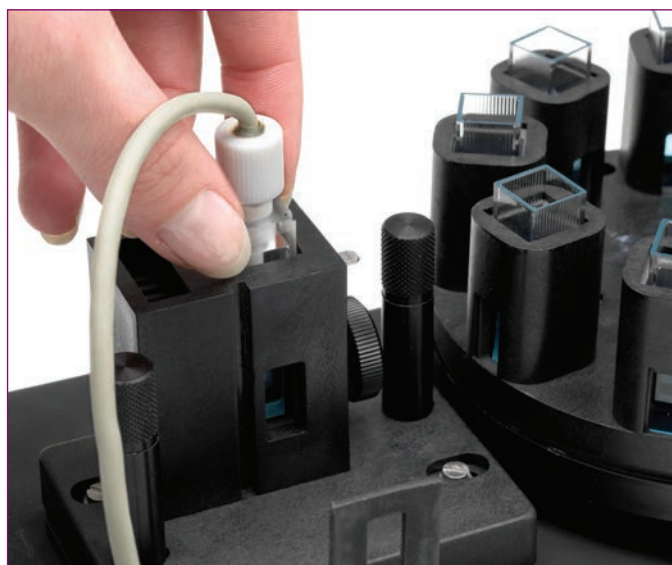

Temperature-measurement Kit

Temperature-measurement Kit

Probe for measuring the temperature within the cell. Includes glass cell. Requires the LAMBDA 25, 35, 45 Accessory Board (L6000500).

| Description | Part No. |
|-----------------------------|----------|
| Temperature-measurement Kit | B0185227 |

Research Peltier Systems



PTP 1+1 and PTP 6+6 Research Peltier Systems

The research Peltier range of accessories is ideal for any application that requires precise control of temperature at, below or above ambient temperature. The ability to operate up to 100 °C allows applications such as DNA melting, protein denaturation and some polymer studies to be performed.

These accessories consist of Peltier-controlled, single or six-cell cuvette holders for the sample and reference channels. Single-channel versions are also available. The accessory includes in-cuvette stirring and the ability to preset temperature programs. These units require a source of cooling water.

| Description | Part No. |
|----------------------------------|----------|
| PTP-1 Research Peltier System | L6310010 |
| PTP 1+1 Research Peltier System | L6310012 |
| PTP-6 Research Peltier System* | L6310011 |
| PTP 6+6 Research Peltier System* | L6310013 |

*For the PTP-6 and 6+6 the sample and reference cell holders must be fitted to the baseplate of the cell changer unit in the sample compartment. In a Lambda 25, 35 or 45 this is the Automatic Linear Transport (B2000186), while in a Lambda 650, 850, 950 or 1050 the Linear Cell Programmer (B2205401) is required.

Peltier Controlled Fluid Circulator (PCB1500)

An external fluid circulator for use with all thermostatted cell holders enabling peltier effect temperature control. With both heating and cooling ability the circulator provides a temperature range of 20 °C to 60 °C with an accuracy of +/- 0.1 °C. Also included is a serial port and documentation to enable PC programming.

| Description | Part No. |
|---|----------|
| Peltier Controlled Fluid Circulator (PCB1500) | N1015158 |



The Fully-automated Universal Reflectance Accessory (URA)

PerkinElmer's unique Universal Reflectance Accessory (URA) is the only fully-automated, multi-angle, absolute specular reflectance accessory available today. For the Lambda 650/850/950/1050.

Simply place the sample on the horizontal sampling plate, select the required measurement angles with a few mouse clicks and scan. Unlike traditional methods, the URA automatically and reproducibly changes the measurement angle, eliminating time-consuming manual mirror adjustments and changes of accessory. This approach reduces running costs and increases productivity. The URA snaps into place in the second sampling position and can quickly be interchanged with integrating spheres and other detector modules.

Features and Benefits

- Measurement range: 190 – 3,100 nm (UV/Vis/NIR), 190 – 900 nm (UV/Vis)
- Angular range: 8° – 68° incident angle
- Depolarization recommended for angles >15°
- Measure separate S&P polarizations using the Double Depolarizer Drive (B0505530)
- Absolute and relative measurements can be made
- Typical applications include the measurement of anti-reflection coatings, high-reflectors, coating thickness and metallic reflectors

| Description | Part No. |
|---------------------------------------|-----------------|
| URA* (UV/Vis only) | L6020208 |
| URA* (UV/Vis/NIR) | L6020202 |
| URA (UV/Vis/NIR) for LAMBDA 1050 only | L6020358 |

*Not available for the LAMBDA 750

Relative Specular Reflectance Accessories

For reflectance or thickness measurements. 6° angle of light incidence. For Lambda 25/35/45/650/750/850/950/1050.

Features and Benefits

- Locates in the standard sample compartment for routine relative reflectance measurements at a 6° fixed angle of incidence
- Accommodates samples from 20 x 20 mm to 100 x 100 mm
- Wavelength range: 175 – 3,300 nm

| Description | Part No. |
|---|-----------------|
| Relative Specular Reflectance Accessory | B0086703 |

Variable-Angle Relative Specular Reflectance Accessory

For relative specular reflectance studies which require data from more than one angle of incidence, the variable angle accessory is ideal. The angular range is from 15 to 70° with an accuracy of +/- 1°. Typical applications include the study of the how the reflectivity of a sample changes with change of incident angle. For the Lambda 25/35/45/650/750/850/950/1050.

Features and Benefits

- Wavelength range: 175 – 3,300 nm
- Locates in standard sample compartment
- Range of angles: 15 – 70°

| Description | Part No. |
|--|-----------------|
| Variable-Angle Relative Specular Reflectance Accessory | B0137314 |

Spare Standard Mirror

For Relative Specular Reflectance Accessory, 6° (B0086703) and Variable Angle Reflectance Accessory (B0137314). This mirror is not calibrated.

| Description | Part No. |
|-----------------------|-----------------|
| Spare Standard Mirror | B0071519 |

Powder Sample Holder Set

For measurement of powder samples.

| Description | Part No. |
|--------------------------|-----------------|
| Powder Sample Holder Set | PELA9040 |



150 mm Integrating Sphere

Snap-in Integrating Spheres for Lambda 650/750/850/950/1050

PerkinElmer's range of snap-in integrating spheres is the industry standard for the measurement of total reflectance, diffuse reflectance and diffuse transmittance measurements for a huge range of sample types. The 150 mm Integrating Sphere is the recommended accessory for measurement of total solar reflectance and transmittance in the glass industry and for the measurement of UV transmittance of paint films in the automotive industry. Many national laboratories use it in R&D studies and for calibration measurements.

The 60 mm and 100 mm Integrating Sphere are used for routine diffuse reflectance and diffuse transmittance measurements. The detector sphere comprises a 60 mm Spectralon detector sphere contained in a snap-in module which fits into the second sample compartment position. This leaves the primary sample compartment free for the use of accessories such as the V-N absolute reflectance accessories, transmission sample holders and polarizer/depolarizer drive.

Features and Benefits

- Measurement range: 200 – 2,500 nm (UV/Vis/NIR), 200 – 900 (UV/Vis)
- InGaAs versions offer higher sensitivity in the near-IR range
- Sampling modes include total and diffuse reflectance at an incident angle of 8°, and total and diffuse transmittance at normal (0°) incidence

| Description | Part No. |
|---|----------|
| 150 mm Integrating Sphere* | L6020204 |
| 60 mm Integrating Sphere | L6020203 |
| 60 mm Detector Sphere* | L6020209 |
| 150 mm InGaAs Integrating Sphere* | L6020322 |
| 60 mm InGaAs Integrating Sphere* | L6020323 |
| 100 mm InGaAs Detector Integrating Sphere** | L6020371 |
| 100 mm PbS Detector Integrating Sphere** | L6020372 |

*Not available for the LAMBDA 750

**For all LAMBDA high performance units: 650, 750, 850, 950, 1050

Accessories for LAMBDA 150 mm Integrating Spheres

Center Mounted Sample Holder, Clip Style

Clip style for films and paper samples.

| LAMBDA Model | Part No. |
|------------------|----------|
| 6XX/8XX/9XX/10XX | PELA9039 |

Center Mounted Sample Holder, Jaw Style

Jaw style for solid samples like glasses, prisms, etc.

| LAMBDA Model | Part No. |
|------------------|----------|
| 6XX/8XX/9XX/10XX | PELA9038 |

Cell Holder

For measurement in 1 cm cuvettes in transmission or reflectance mode.

| LAMBDA Model | Part No. |
|------------------|----------|
| 6XX/8XX/9XX/10XX | C6951019 |

Small Spot Accessory Kit

Lens kit for reducing beam size to the transmittance position, to the center mount and to the diffuse reflectance position. Requires Reflectance Aperture Kit, Part No. L6020314.

| LAMBDA Model | Part No. |
|------------------|----------|
| 6XX/8XX/9XX/10XX | L6020211 |

Reflectance Only Small Spot Kit

Lens kit for reducing beam size to the reflectance position. Requires Sample Compartment Iris, Part No. L6020316.

| LAMBDA Model | Part No. |
|------------------|----------|
| 6XX/8XX/9XX/10XX | L6020313 |

100 mm Integrating Spheres for LAMBDA 650, 750, 850, 950, 1050

| Description | Part No. |
|-----------------------------------|----------|
| Cuvette Holder | L6022022 |
| Powder Cell Holder | L6022025 |
| Reference Sample Holder | L6022018 |
| Transmittance-only Small Spot Kit | L6022023 |
| Reflectance-only Small Spot Kit | L6022024 |

50 mm Integrating Sphere for Lambda 35

Simplifies analysis of a wide variety of samples, including solids, powders, pastes and liquids. For scattered transmittance and diffuse reflectance measurement. Spectralon coated, wavelength range 250 to 1,100 nm.



| LAMBDA Model | Part No. |
|--------------|----------|
| LAMBDA 35 | C6951014 |

Accessories for LAMBDA 35 Integrating Spheres

| Description | Part No. |
|--|----------|
| 1.25" Calibrated Spectralon Diffuse Reflectance Standard | PELA9057 |
| Powder Sample Holder Set | PELA9040 |

PRECISE TRANSMISSION AND REFLECTANCE MEASUREMENTS

Double Polarizer drive for LAMBDA 650/750/850/950/1050



When samples are oriented and polarize incident light, it is important to correct for the inherent polarizing effect of the spectrometer's optics by using a depolarizer. Another important application is to make measurements using a specific orientation of incident radiation e.g. for crystalline materials and polymers.

Features and Benefits

- Measurement range (Depolarization): 185 – 2,600 nm
- Measurement range (with Polarizers): 400 – 700 nm (Film), 300 – 2,600 nm (Glan-Thompson), 210 – 1,000 nm (Glan-Taylor)
- Fits into standard sample compartment alongside reflectance accessories and transmittance sample holders
- Suitable for reflectance and transmittance measurements

The high performance Double Polarizer/Depolarizer Drive is installed in the primary sample compartment. The polarization/depolarization orientation can be fully automated, changed by a scan at a fixed wavelength or with a stepping mode. Resolution of 0.25° for scanning. The polarization (depolarization) orientation in the stepping mode can be changed at up to 20 wavelength positions. Applications include specular reflectance studies of optics, coatings, metallic reflectors and thin films. The Double Polarizer Drive can operate with the Universal Reflectance Accessory or manual specular reflectance and transmission accessories.

| Description | Part No. |
|--|-----------------|
| Double Polarizer drive for LAMBDA 650/750/850/950/1050 | B0505530 |

The Double Polarizer Drive requires, but does not include, one or two of the following polarization elements:

Polarizer/Depolarizer Elements for the Double Polarizer Drive

A range of polarizing materials is available, according to the required wavelength range. For equal energy in the sample and reference beams of the spectrometer, two are required.

| Description | Wavelength Range | Part No. |
|--------------------------------------|------------------|-----------------|
| Film Polarizer | 400 – 700 nm | B2205022 |
| High Performance Polarizer Crystal | 300 – 2,600 nm | B0505284 |
| Glan-Taylor Polarizer Crystal | 210 – 1,000 nm | N1010520 |
| Depolarizer Crystal (98% efficiency) | 190 – 2,600 nm | B2205021 |

Common-beam Depolarizer

Another approach to depolarization involves the use of a software controlled depolarizer inside the spectrometer. Driven by a stepper drive, and controlled by UV WinLab™ software, the Common-beam Depolarizer operates between 190 and 2,600 nm uses a double-wedge quartz/Suprasil design for 92% depolarization efficiency. Service installation is required.

| Description | Part No. |
|-------------------------|-----------------|
| Common Beam Depolarizer | B0501282 |

Sipper

Peristaltic Sipper "PESI"

Sampling and purging time selectable from keyboard.

For LAMBDA 25/35/45/10/20/40 no accessory PCB necessary. Requires, but does not include, accessory PCB for LAMBDA Bio 11, 12, and 14, (B0509681/B2190034) or accessory PCB for LAMBDA 18/19 (B0124984/B0116378).

For LAMBDA 6XX/8XX/9XX/10XX, requires, but does not include, Installation Kit for LAMBDA 800/900 (B2500123) and Accessory PC Board for LAMBDA 800/900 (B2205116).

Requires, but does not include, Flowcell of choice with screw connector.

| Description | Part No. |
|-------------------------|-----------------|
| Peristaltic Sipper PESI | B2190036 |

FIBER OPTICS ACCESSORIES



Transfer-Optic for 1X/2X/3X/4X/Bio Part No. B0509546

Transfer-Optic for Mono-Fibers

Fiber optic transfer holder for LAMBDA spectrophotometers. Requires pair of Mono-Fibers 2x2 or 2x10 meters and/or optrode. Other optrodes available on request.

| LAMBDA Model | Part No. |
|------------------|-----------------|
| 1X/2X/3X/4X/Bio | B0509546 |
| 650/850/950/1050 | L6020290 |

Pair of Mono-Fibers

2x2 meters each.

| Wavelength | Part No. |
|--------------------------|-----------------|
| 250 to 900 nm (UV/Vis) | B0196912 |
| 400 to 2400 nm (Vis/NIR) | B0509591 |

Fiber Optic Dip Probe

The Fiber Optic Dip Probe is a 15 mm, 316 grade stainless steel probe with a wavelength of 200-1100 nm. Requires but does not include: Transfer-Optic for Mono-Fibers, Light Shield (N1016074) and one of the following Probe Tips: Probe Tip, 2 mm pathlength (N1016073); Probe Tip, 5 mm pathlength (N1016072); or Probe Tip, 10 mm pathlength (N1016071).

| LAMBDA Model | Part No. |
|--------------|-----------------|
| All | N1016070 |

Light Shield

For use with Fiber Optic Dip Probe (N1016070).

| LAMBDA Model | Part No. |
|--------------|-----------------|
| All | N1016074 |

Probe Tip

For use with Fiber Optic Dip Probe (N1016070).

| Pathlength | Part No. |
|------------|-----------------|
| 2 mm | N1016073 |
| 5 mm | N1016072 |
| 10 mm | N1016071 |

GENERAL PURPOSE OPTICAL BENCH KITS FOR THE LAMBDA 6XX/8XX/9XX/10XX

General Purpose Optical Bench (GPOB)

General Purpose Optical Bench for Lambda 650/850/950/1050

The GPOB features a magnetized, ruled optical bench with a moveable 60 mm Spectralon® or InGaAs Spectralon® collection integrating sphere. Samples up to 400 mm in pathlength can be analyzed using the General Purpose Optical Bench. Wavelength Range: 190 nm to 2500 nm.

| Description | Part No. |
|--------------------------------------|-----------------|
| General Purpose Optical Bench | PELA1003 |
| InGaAs General Purpose Optical Bench | L6020328 |

Sample Holder Mount Kit

Two cantilever sample holders with magnetic bases.

| Description | Part No. |
|-------------------------|-----------------|
| Sample Holder Mount Kit | PELA1005 |

Variable Angle Transmittance Sample Holder Kit

Holds samples at an accurately measured angle to the incident beam for measurement of transmittance. Samples can be up to 1 cm thick and up to 10 cm square.

| Description | Part No. |
|--|-----------------|
| Variable Angle Transmittance Sample Holder Kit | PELA1006 |

Optical Bench Kit

Two magnetized mounted iris diaphragms on two optical rails with mounts.

| Description | Part No. |
|-------------------|-----------------|
| Optical Bench Kit | PELA1008 |

Short Focal Length Mirror Kit, Spot Incidence

Kit consists of a short focal length (20 to 30 mm) concave mirror on an adjustable base with magnetic mounts to allow for small spot incidence of curved samples.

| Description | Part No. |
|---|-----------------|
| Short Focal Length Mirror Kit, Spot Incidence | PELA1013 |

Beam Blocker Kit

Optical black beam blocker on adjustable base with magnetic mounts.

| Description | Part No. |
|------------------|-----------------|
| Beam Blocker Kit | PELA1014 |

Fiber Optic Measurement Stage and Holder Kit

Includes two fiber optic holders to allow for measurement of small diameter fibers and fixed apertures.

| Description | Part No. |
|--|-----------------|
| Fiber Optic Measurement Stage and Holder Kit | PELA1015 |

Polarimetry Cells

PerkinElmer offers a wide range of polarimetry sample cells for virtually all applications, including micro cells, short path cells, flow cells, and fused silica (quartz) cells. Use quartz cells for all wavelengths and for elevated temperatures (200 °C, maximum). Use glass cells only for visible wavelengths, above 400 nm.

Each of our polarimetry cells is individually tested with respect to its pathlength. The actual pathlength of each cell is engraved on the cell to the nearest 0.001 cm (i.e. to the nearest 0.01 mm), together with the serial number of the cell.

Cells are designed for easy filling and emptying. They are jacketed for thermostating with constant temperature water, except for one flowcell. Their residual cell rotation is almost zero and may be neglected in most measurements.

Standard Cells for Polarimetry

| Material | Lightpath | Cell Vol. | Part No. |
|---------------|-----------|-----------|-----------------|
| Quartz | 100 mm | 3.0 mL | B0507403 |
| Quartz | 100 mm | 6.2 mL | B0041696 |
| Optical Glass | 100 mm | 3.0 mL | B0507447 |
| Optical Glass | 100 mm | 6.2 mL | B0041693 |

Short Path Cells for Polarimetry

| Material | Lightpath | Cell Vol. | Part No. |
|----------------------|-----------|-----------|-----------------|
| Quartz, Fused Silica | 20 mm | 1.3 mL | B0022087 |
| Optical Glass | 10 mm | 0.5 mL | B0017052 |
| Optical Glass | 1 mm | 0.25 mL | B0017057 |

Micro Cells for Polarimetry

| Material | Lightpath | Cell Vol. | Part No. |
|-----------------------|-----------|-----------|-----------------|
| Quartz, Fused Silica* | 100 mm | 0.35 mL | B0131186 |
| Optical Glass | 100 mm | 1.0 mL | B0017047 |

* With reduced inner diameter

Beaker Cells for Polarimetry

Beaker cells are not thermostatable.

| Material | Lightpath | Cell Vol. | Part No. |
|----------------------|-----------|-----------|-----------------|
| Quartz, Fused Silica | 100 mm | 50 mL | B0023363 |
| Optical Glass | 100 mm | 50 mL | B0017041 |

Flow Cells for Polarimetry

| Material | Lightpath | Cell Vol. | Part No. |
|-----------------------|-----------|-----------|-----------------|
| Quartz, Fused Silica* | 100 mm | 6.2 mL | B0507451 |
| Optical Glass | 100 mm | 5.0 mL | B0017054 |

* With two PTFE tubing (4 mm i.d.)

Pluggable Coupling

For cell thermostating.

| Connection | Part No. |
|------------|-----------------|
| Female | B0023491 |
| Male | B0023492 |

PTFE Stopper

10 mm long.

| Cell Compatibility | Diameter | Part No. |
|---|----------|-----------------|
| 017 047/017 057/022 086 - 022 091/023 365/037 634/037 635/022 085/037 357 | 3 mm | B0017059 |
| 041 693/041 696 | 6 mm | B0041695 |

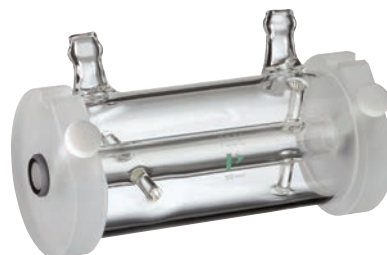

100 mm pathlength
Polarimetry Cell

Long Lifetime Source Lamps

High-quality source lamps, specially selected to optimize the performance of all PerkinElmer polarimeters, offer high radiant energy and a long operating lifetime. Their high output ensures that very accurate measurements of optical rotation can be made, even when the sample absorbs strongly.

| Description | Polarimeter Model | Part No. |
|----------------------|--|-----------------|
| Sodium, 20 W | 341/343/343plus/341LC/ 241/241MC/243/243B | L9004741 |
| Mercury Vapor (St46) | 341/343S/343plus/341LC | B0510581 |



Secondary Quartz Standards for Instrument Validation

Quartz control plates provide traceable instrument calibration in the visible spectral range, ensuring the highest standards of accuracy and precision for all measurements. All quartz control plates feature a thermostatable housing.

| Description | Nominal Rotation | Part No. |
|-------------------------|------------------|-----------------|
| Quartz Control Plate +1 | +1° at 589 nm | B0098800 |
| Quartz Control Plate -1 | -1° at 589 nm | B0098799 |

Optional Interference Filter

For Model 341 Polarimeters. Service installation recommended.

| Wavelength | Part No. |
|------------|-----------------|
| 302 nm | B0094404 |
| 325 nm | B2100154 |
| 405 nm | B0062666 |



HIGH QUALITY CELLS FOR ALL APPLICATIONS

Standard rectangular macro cells are the most frequently-used type of spectroscopy cell for routine liquids analysis. Micro cells have the same outside dimension as the macro cells but the cell walls have been thickened, limiting the interior sample chamber width to 2 mm. This reduces the sample requirements by 80%.

For full details of the properties of Quartz SUPRASIL and Special Optical Glass see UV/Vis Macro Cells.

Macro with PTFE Lid or with PTFE Stopper

| Material | Qty. | Light Path | Outside Dim. H x W x D | Inside Width | Base Thickness | Cell Volume | Windows | Part No. |
|--------------------------|------|------------|---------------------------|--------------|----------------|-------------|---------|-----------------|
| with PTFE Lid | | | | | | | | |
| Special Optical Glass | 2 | 10 x 10 mm | 45 x 12.5 x 12.5 mm | 10 mm | 1.25 mm | 3.5 mL | 4 | B0631104 |
| Quartz SUPRASIL® | 2 | 10 x 10 mm | 45 x 12.5 x 12.5 mm | 10 mm | 1.25 mm | 3.5 mL | 4 | B0631107 |
| with PTFE Stopper | | | | | | | | |
| Special Optical Glass | 2 | 10 x 10 mm | 46 x 12.5 x 12.5 mm | 10 mm | 1.25 mm | 3.5 mL | 4 | B0631110 |
| Quartz SUPRASIL | 2 | 10 x 10 mm | 46 x 12.5 x 12.5 mm | 10 mm | 1.25 mm | 3.5 mL | 4 | B0631113 |

Semi-micro with PTFE Lid or PTFE Stopper

Semi-micro cells have the same outside dimensions as the macro cells but the cell walls have been thickened slightly, limiting the interior sample chamber width to 4 mm. This reduces the sample requirements by 60%. Each package contains two cells with two clear windows each.

| Material | Qty. | Light Path | Outside Dim. H x W x D | Inside Width | Base Thickness | Cell Volume | Windows | Part No. |
|--------------------------|------|------------|---------------------------|--------------|----------------|-------------|---------|-----------------|
| with PTFE Lid | | | | | | | | |
| Special Optical Glass | 2 | 10 x 4 mm | 45 x 12.5 x 12.5 mm | 4 mm | 1.25 mm | 1.4 mL | 4 | B0631115 |
| Quartz SUPRASIL® | 2 | 10 x 4 mm | 45 x 12.5 x 12.5 mm | 4 mm | 1.25 mm | 1.4 mL | 4 | B0631116 |
| with PTFE Stopper | | | | | | | | |
| Special Optical Glass | 2 | 10 x 4 mm | 46 x 12.5 x 12.5 mm | 4 mm | 1.25 mm | 1.4 mL | 4 | B0631117 |
| Quartz SUPRASIL | 2 | 10 x 4 mm | 46 x 12.5 x 12.5 mm | 4 mm | 1.25 mm | 1.4 mL | 4 | B0631118 |

Fluorescence Cells for Magnetic Stirrers

| Material | Qty. | Light Path | Outside Dim. H x W x D | Inside Width | Base Thickness | Cell Volume | Windows | Part No. |
|-------------------------|------|------------|---------------------------|--------------|----------------|-------------|---------|-----------------|
| Macro/Semi-micro | | | | | | | | |
| Quartz SUPRASIL | 1 | 4 x 4 mm | 45 x 12.5 x 12.5 mm | 4 mm | 4.5 mm | 500 µL | 4 | B0631132 |
| Magnetic Stirrer Fleas | 6 | | | | | | | 04978499 |

Micro with PTFE Lid or with PTFE Stopper

| Material | Qty. | Light Path | Outside Dim. H x W x D | Inside Dim. width | Base Thickness | Cell Volume | Windows | Part No. |
|--------------------------|------|------------|---------------------------|----------------------|-------------------|----------------|---------|-----------------|
| with PTFE Lid | | | | | | | | |
| Special Optical Glass | 2 | 10 x 2 mm | 45 x 12.5 x 12.5 mm | 2 mm | 1.25 | 700 µL | 4 | B0631119 |
| Quartz SUPRASIL | 2 | 10 x 2 mm | 45 x 12.5 x 12.5 mm | 2 mm | 1.25 | 700 µL | 4 | B0631120 |
| with PTFE Stopper | | | | | | | | |
| Special Optical Glass | 2 | 10 x 2 mm | 40 x 12.5 x 12.5 mm | 2 mm | 1.25 | 700 µL | 4 | B0631121 |
| Quartz SUPRASIL | 2 | 10 x 2 mm | 40 x 12.5 x 12.5 mm | 2 mm | 1.25 | 700 µL | 4 | B0631122 |

Quartz SUPRASIL Ultra-micro with PTFE Stopper (B0631124)



Quartz SUPRASIL Micro with PTFE Lid (B0631120)



Quartz SUPRASIL Micro without Lid (B0631123)



Micro Cells without Lid

| Material | Qty. | Light Path | Outside Dim. H x W x D | Inside Dim. H x W x D | Base Thickness | Cell Volume | Windows | Remarks | Part No. |
|--------------------|------|------------|---------------------------|--------------------------|-------------------|----------------|---------|----------------------|-----------------|
| Quartz SUPRASIL* | 2 | 5 x 5 mm | 33.5 x 7.5 x 7.5 mm | 32.25 x 5 x 5 mm | 1.25 mm | 600 µL | 5 | | B0631123 |
| Quartz SUPRASIL* | 2 | 5 x 5 mm | 46 x 7.5 x 7.5 mm | 38.75 x 5 x 5 mm | 1.25 mm | 850 µL | 5 | w/ PTFE Stopper NS 5 | B0631142 |
| Micro Cell Adapter | 4 | | | | | | | | L2250139 |

*Requires Microcell Adapter (L2250139). Microcuvette Adapter allows 5 mm pathlength microcells to be used in any of the cuvette holders. (pkg. 4)

Ultra-micro Cells with PTFE Stopper

Ultra-micro cells use a narrower sample chamber, raising it directly into the center of the light path and masking it with black quartz. This design optimizes the use of smaller sample volumes. All Ultra-micro cells contain one cell and two clear windows.

| Material | Qty. | Light Path | Center Height | Outside Dim. H x W x D | Aperture | Chamber Volume | Filling Volume | Windows | Part No. |
|-----------------|------|------------|---------------|---------------------------|----------|-------------------|-------------------|---------|-----------------|
| Quartz SUPRASIL | 1 | 10 x 2 mm | 15 mm | 45 x 12.5 x 12.5 mm | 5 x 2 mm | 100 µL | 120 µL | 3 | B0631124 |

Quartz SUPRASIL Flow-through Cells for Fluorimetry (B0631126)



Flow-through Cells for Fluorescence Spectroscopy

Flow-through cells are used for measuring samples with continuous flow or with Sippers where individual samples are aspirated into the cell. All cells have center heights of 15 mm. Each package contains one cell with two clear windows. The cells listed below are compact with two screw connectors, M6x1 and 500 mm length FEP tubing – 1.9 mm o.d., 1.1 mm i.d.

| Material | Qty. | Light Path | Outside Dim. | Inside Width H x W x D | Base Thickness | Cell Volume | Windows | Part No. |
|---|------|-------------|--------------|---------------------------|-------------------|----------------|---------|-----------------|
| Macro Inlet/Outlet Tubes on Top | | | | | | | | |
| Quartz SUPRASIL | 1 | 10 x 6.5 mm | 15 mm | 45 x 12.5 x 12.5 mm | 11 x 6.5 mm | 750 µL | 3 | B0631126 |
| Semi-micro Inlet/Outlet Tubes on Top | | | | | | | | |
| Quartz SUPRASIL | 1 | 10 x 4 mm | 15 mm | 45 x 12.5 x 12.5 mm | 11 x 4 mm | 450 µL | 3 | B0631127 |

*Compact with two (2) screw connectors and FEP tubing.

Temperature-controlled Cells for Fluorimetry

| Material | Qty. | Light Path | Outside Dim. H x W x D | Inside Width | Base Thickness | Cell Volume | Windows | Part No. |
|-----------------|------|------------|---------------------------|--------------|-------------------|----------------|---------|-----------------|
| Quartz SUPRASIL | 1 | 10 x 4 mm | 48 x 12.5 x 12.5 mm | 4 mm | 11 x 3.2 mm | 1.4 mL | 5 | B0631125 |

HIGH-SENSITIVITY, ULTRA-STABLE LAMPS



Xenon Source Lamp

Xenon Source Lamps for LS30/40/45/50/50B/55

PerkinElmer Fluorescence Spectrometers use pulsed Xenon discharge lamps, which are not only very reliable and stable, but also provide remarkable sensitivity with a peak intensity exceeding 1 KW.

To maintain optimum stability and sensitivity of your instrument, installation of a new lamp by a PerkinElmer service engineer is recommended. Additionally, Xenon lamp quartz envelopes are under pressure, requiring eye protection and extreme caution in handling.

| Description | Part No. |
|--|----------|
| Xenon Source Lamp for LS30/40/45/50/50B/55 | L2251157 |
| Festoon Lamp for the LS Series* | 04969486 |

*The Festoon Lamp is used along with the Xenon Lamp to maintain even triggering and stability.



Set of six Luminescence Sample Blocks

Checking the Day-to-Day Reproducibility of your Fluorescence Spectrometer

For day-to-day checks on reproducibility and wavelength calibration a set of six PMMA (polymethyl-methacrylate) blocks can be used. These have emission characteristics in the following wavelength ranges:

| | Wavelength Range (nm) |
|---|------------------------------------|
| 1 | 300 – 400 (anthracene/naphthalene) |
| 2 | 420 – 600 (ovalene) |
| 3 | 300 – 400 (p-terphenyl) |
| 4 | 400 – 600 (tetraphenyl/butadiene) |
| 5 | 600 – 640 (europium) |
| 6 | 540 – 640 (rhodamine B) |

For checking instrument sensitivity, a 10 mm sealed cell contains high-purity water, which acts as a constant sample to reproducibly measure signal-to-noise using the Raman band.

| Description | Part No. |
|---------------------------------------|----------|
| Luminescence Sample Blocks (Set of 6) | 52019600 |
| Sealed Water Sample | L2251293 |

Red-sensitive Photomultiplier for the LS50B/45/55

The Red-sensitive Photomultiplier is a useful addition to the LS-series spectrometers to extend the detection range out to 900 nm. The full detection range is 200 – 900 nm.

Requires installation by a PerkinElmer service engineer.

| Description | Part No. |
|-------------------------------|----------|
| Red-Sensitive Photomultiplier | L6020281 |

Ideal for Polarization Studies, Protein Folding and DNA Melting.

Changes in temperature affect fluorescence intensity. A simple, inexpensive and accurate way to control sample temperature is to use a thermostatable cell holder through which water from an external water-bath can be circulated. For temperature ramping studies and experiments where more rapid heating and cooling is required, a single-cell Peltier-thermostatted accessory is available.

Single-Cell Peltier Accessory

For analyses where more rapid heating and cooling is required, a single-cell, water-cooled Peltier accessory is available. Operation between 0 – 100 °C with a resolution of 0.1 °C makes it the ideal choice for a wide variety of applications, for example, thermal denaturation of proteins. Temperature control is via keypad or the optional TempScan software.

| Description | Part No. |
|-------------------------------|----------|
| For LS50/45/55 | |
| Single-cell Peltier Accessory | L2250150 |
| BL Studio, FL | L2258003 |
| BL Peltier, Add-on | L2258004 |

Requires a source of liquid cooling, such as a water-circulator.
Requires Accessory PCB Kit (L2250162) for use with LS-45

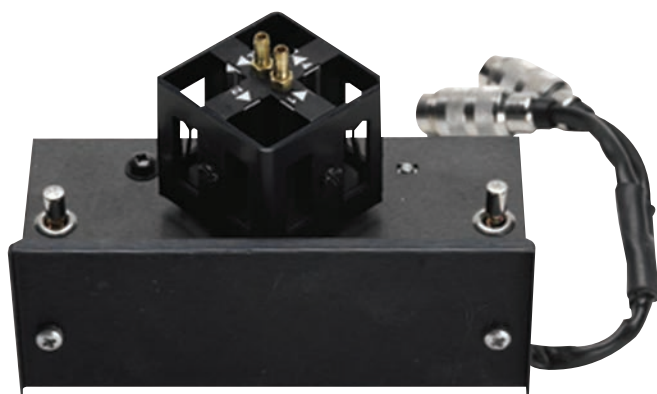

Four-position Thermostatted Automatic Cell Changer

Four-position Thermostatted Automatic Cell Changer

The Four-position Cell Changer accommodates four square, 10 mm pathlength cells or four micro-cells with adapters.

| Description | Part No. |
|---|----------|
| Four-position Thermostatted Automatic Cell Changer For LS50B/55 | L2250134 |

Requires, but does not include, 4 Adapters (L2250139) to work with micro cells. Includes 6 Stirrer Fleas.

Single-position Thermostatted Cell Holder

Water-thermostatted cell holder for a 10 mm pathlength cell. This cell holder is included as standard with the LS-45 and LS-55.

| Description | Part No. |
|---|----------|
| Single-position Thermostatted Cell Holder For LS50B/45/55 | L2250140 |

Single-position Thermostatted Cell Holder, with Stirrer

Cell holder with magnetic stirrer for a 10mm pathlength cell, water thermostatted. Includes six stirrer Fleas (04978499).

| Description | Part No. |
|---|----------|
| Single-position Thermostatted Cell Hold, with Stirrer | L2250141 |



Biokinetics Accessory for LS50/45/55

Biokinetics Accessory

The Biokinetics Accessory consists of a magnetically stirred single-cell holder with a built-in temperature sensor (0 – 100 °C) event marker. Thermostattable by an external water-bath (not included). Includes 6 Stirrer Fleas. Requires Accessory PCB Kit (L2250162) for use with LS-45.

| Description | Part No. |
|----------------|----------|
| For LS50/45/55 | L2250145 |

Low-temperature Luminescence Accessory

For cooling samples to liquid nitrogen temperature. Used for measuring fluorescence or phosphorescence. Includes a pack of five sample tubes (52126027).

Low-temperature Sample Tubes

| Description | Pkg. | Part No. |
|--|------|----------|
| Low-temperature Luminescence Accessory | | L2250136 |
| Low-temperature Sample Tubes | 5 | 52126027 |

INCREASE YOUR APPLICATION CAPABILITIES

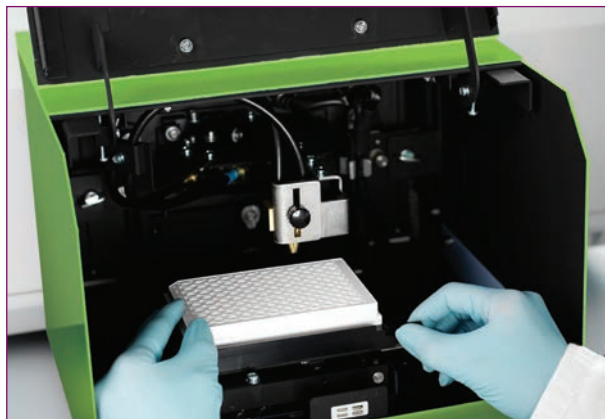

Fluorescence “Well-plate Reader”

Well-plate Reader Accessory for LS50B/55

The Well-plate Reader Accessory allows you to switch from a cuvette-based system to a well-plate reader in seconds. The accessory is front-mounted, providing easy access to standard well-plates.

Features and Benefits

- Measures in fluorescence, phosphorescence, bioluminescence and chemiluminescence modes
- Fiberoptic light feed for permanent alignment and high performance
- Standard or far-UV fiberoptics
- Easily removes and installs for switching between plate and cuvette measurements
- Can create programs for single end-point and kinetics analysis
- Optional plug-in software module allows the user to collect multiple spectra per well
- Measures up to 96 well plates

| Description | Part No. |
|---|-----------------|
| For work above 260 nm Excitation, 340 nm Emission | L2250035 |
| For work above 260 nm Excitation and Emission | L2250042 |

Installation by a PerkinElmer service engineer is required. Includes one pack of white Microplates (L2251692).

96-Well Microplates

| Description | Pkg. | Part No. |
|-----------------------|------|-----------------|
| Hi-White flat bottom. | 100 | L2251692 |

Ideal for DNA Quantitation, Enzyme-linked Assays, Protein Measurements, Fluorescent ELISAs, Cell Viability Testing and Drug and Steroid Testing.

Liquid Sipper Accessory

The Liquid Sipper Accessory is ideal for the automation of liquid sampling, providing productivity improvements and sample-handling convenience. The accessory consists of a 16 microliter volume flowcell and a peristaltic pump controlled by the instrument software, which automatically transfers samples from the vessel to the cuvette.

| Description | Part No. |
|--------------|-----------------|
| For LS50B/55 | L2250135 |

Includes Flowcell, Peristaltic Pump, 0.4 mm FEP Inlet Tube and 0.7 mm FEP Outlet Tube. Requires installation by a PerkinElmer service engineer.



Liquid Sipper Accessory

LC Flow Cell Accessory

The LC Flow Cell Accessory allows you to detect trace components eluted from a liquid chromatograph. Fluorescence can be monitored continuously at selected excitation and emission wavelengths, simply by replacing the standard cell holder with an LC flow cell.

| Description | Part No. |
|-----------------|-----------------|
| For LS50B/45/55 | L2250138 |

Includes Flowcell, Peristaltic Pump, 0.4 mm FEP Inlet Tube and 0.7 mm FEP Outlet Tube. Requires installation by a PerkinElmer service engineer.

High-sensitivity Alternative to a Dedicated LC Fluorescence Detector.



Remote Fiber-optic Accessory

Remote Fiber-optic Accessory

The Remote Fiber-optic Accessory allows you to make the measurement at the sample, without needing to take the sample to the instrument. Includes bifurcated synthetic fused-silica fiber-optics (1 m in length), which operate over the range 280 – 800 nm, and transfer-optics which mount in the spectrometer. This accessory is ideal for remote, non-destructive testing of fluorescent papers and fabrics, or remote sampling of hazardous materials.

| Description | Part No. |
|-----------------|----------|
| For LS50B/45/55 | L2250144 |

Total Emission Accessory

The Total Emission Accessory enhances the sensitivity of the fluorescence detection for samples with weak emission, and is recommended for bioluminescence and chemiluminescence experiments. The accessory uses a plane mirror that swings into place in front of the emission monochromator so that the total fluorescence of the sample can be measured.

The use of cut-off emission filters is recommended to reduce emission from other wavelengths. Five software-controlled emission filters are supplied with the LS55 spectrometers.

| Description | Part No. |
|--------------|----------|
| For LS50B/55 | L2250101 |

Requires installation by a PerkinElmer service engineer.



Front-surface Accessory*

For Measurements on Solids, Powders and Viscous or Opaque Liquids

The simple-to-use Front-surface Accessory extends your measurement capabilities to a wide variety of solid and semi-solid samples, including powders, paper, plastic films, cloth samples, TLC plates, gels and turbid liquids. The accessory can be used with the LS-50B/45/55 spectrometers.

Features and Benefits

- Used for fluorescence and phosphorescence measurements
- Sample can be placed in the accessory directly or held in the synthetic fused silica window powder holder
- Ultra-small volumes or viscous samples can be sandwiched between the two windows
- Opaque and turbid samples can be measured in small cuvettes (under 10 mm)

| Description | Part No. |
|---|----------|
| Front-surface Accessory | 52123130 |
| Powder Sample Holder | |
| For use with Front Surface Accessory (52123130) | 52123164 |
| Synthetic Fused Silica Window | |
| For Powder Sample Holder | 52123814 |

*Includes Powder Sample Holder (52123164).

DSC SAMPLE PANS, COVERS AND CRIMPERS

Standard Sample Pan Crimper Press

Used to crimp covers on standard DSC pans of aluminum, gold and copper. Design incorporates a replaceable crimper head.



| Description | Part No. |
|-----------------------------------|-----------------|
| Standard Sample Pan Crimper Press | 02190048 |

Universal Crimper Press

The Universal Crimper Press provides high quality pan sealing for the autosampler sample pans/hermetically sealed pans and can also crimp standard aluminum pans, large volume stainless steel (24 bar) and volatile pans. This is achieved simply by using the appropriate sealing insert. Includes sample pan suction tool and inserts to seal 10, 30 and 50 µL sample pans.



| Description | Part No. |
|-------------------------|-----------------|
| Universal Crimper Press | B0139005 |

ALUMINUM SAMPLE PANS AND COVERS

| Sample Pan | Operating Range | Vol. (µL) | Max Pressure | Qty. | Crimper (Sealer) | Part No. |
|--|-----------------|-----------|--------------|---------|------------------------------------|------------------|
| Open/Crimped Pans | | | | | | |
| ▶ Standard Aluminum Pans and Covers | -170° to 600 °C | 40 | Ambient | 400 | 02190048 or B0139005 with B0508921 | 02190041 |
| ▶ Supra clean Aluminum pans | -170° to 600 °C | 40 | Ambient | 400 | 02190048 or B0139005 with B0508921 | 02192005 |
| ▶ Aluminum Sample Pans | -170° to 600 °C | 28 | Ambient | 200 | N5356027 or N5356028 | N5356010 |
| ▶ Aluminum Sample Pans | -170° to 600 °C | 45 | Ambient | 400 | N5356027 or N5356028 | N5356012 |
| ▶ Aluminum Pans for HyperDSC® | -170° to 600 °C | 40 | Ambient | 100 | Not Required | N5203115 |
| Vented/Pierced Pans | | | | | | |
| ▶ Aluminum Covers (Pierced) | -170° to 600 °C | | 0.05 mm hole | 400 | B0139005 | B7001014 |
| ▶ Volatile Aluminum Pans and Covers (Pierced)** | -170° to 600 °C | 20 | 0.05 mm hole | 100 | 02190061 or B0139005 with B0144637 | N5190788 |
| ▶ Aluminum (Vented) Pans | -170° to 600 °C | 30 | Vented | 400 | B0139005 | B0143018 |
| ▶ Aluminum (Vented) Pans | -170° to 600 °C | 50 | Vented | 400 | B0139005 | B0143019 |
| Hermetically Sealed/Volatile Pans | | | | | | |
| ▶ Aluminum Pans | -170° to 600 °C | 10 | 1 bar | 400 | B0139005 | B0143015 |
| ▶ Aluminum Pans | -170° to 600 °C | 30 | 1 bar | 400 | B0139005 | B0143016 |
| ▶ Aluminum Pans | -170° to 600 °C | 50 | 1 bar | 400 | B0139005 | B0143017 |
| ▶ Aluminum Covers (solid)* | -170° to 600 °C | | 1 bar | 400 | B0139005 | B0143003 |
| ▶ Aluminum Covers (solid)*** | -170° to 600 °C | | 3 bar | 400 | B0139005 | B0143004 |
| ▶ Aluminum Pans and Covers | -170° to 600 °C | 20 | 2 bar | 400 | 02190061 or B0139005 with B0144637 | 02190062 |
| ▶ Aluminum Pans**** | -170° to 600 °C | 25 | 2 bar | 400 | B0139005 | B0143020 |
| ▶ Aluminum Pans**** | -170° to 600 °C | 40 | 2 bar | 400 | B0139005 | B0143021 |
| ▶ Aluminum Pans and Covers | -170° to 600 °C | 10 | 3 bar | 400 | B0139005 | B0169319 |
| ▶ Aluminum Pans and Covers | -170° to 600 °C | 30 | 3 bar | 400 | B0139005 | B0169320 |
| ▶ Aluminum Pans and Covers | -170° to 600 °C | 50 | 3 bar | 400 | B0139005 | B0169321 |
| ▶ Non-coated Aluminum Sample Pans and Covers | -170° to 500 °C | 7.5 | 3 bar | 200 | N5356027 or N5356028 | N5356008 |
| ▶ Aluminum Pans and Cover Starter Kit | | | 3 bar | 200/200 | B0139005 | B0510800 |
| Photo DSC Pans | | | | | | |
| ▶ Aluminum Pans for Photocalorimetric Analysis | -170° to 600 °C | 12.5 | Ambient | 100 | Not Required | B0196858 |
| ▶ Aluminum Pans and Quartz Covers | -170° to 600 °C | 12.5 | Ambient | 100 | Not Required | B0198030 |
| ▶ Quartz Covers | | | | 10 | | B0181091 |
| ▶ Aluminum Pans and Covers - hand sealable | -170° to 600 °C | 1 | Ambient | | Not Required | L90004787 |
| ▶ Aluminum Pans and Covers - 6.7 mm x 2.7 mm | -170° to 600 °C | 1 | Ambient | | Not Required | L90004788 |
| ▶ For use with DSC 4000, DSC 6000, DSC 8000, DSC 8500, Diamond DSC, Pyris 1 DSC, DSC 7, DSC 6, Pyris 6 DSC and Jade DSC ▶ For use with Sapphire DSC | | | | | | |

* For use with B0143015, B0143016, B0143017

** 50 Micron hole; use for boiling point, heat of vaporization, sublimation studies.

*** For use with B0149319, B0149320, B0149321

**** Lids must be ordered separately as B0143003

High Pressure Capsule Sealing Tool

This reliable sealing tool is fast and precise. It employs a built-in torque clutch which guarantees that all capsules are closed with the same torque.



| Description | Part No. |
|------------------------------------|-----------------|
| High-Pressure Capsule Sealing Tool | B0182864 |

Quick Press

The Quick Press is a convenient device for sealing stainless steel pans, covers and o-rings (03190218 and 03190029). Requires but does not include spacer die (03191047).

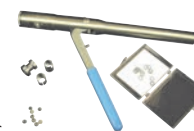

| Description | Part No. |
|------------------------|-----------------|
| Quick Press | 09908467 |
| Quick Press Spacer Die | 03191047 |

High Pressure Sample Pans (24 to 150 bar)

Pans contain the sample in a sealed environment throughout an experiment. The sealing suppresses the vaporization of a solvent or contains a volatile reaction product, thereby eliminating the interfering effects of the heat of vaporization.



Stainless Steel Pans with O-rings

| Sample Pan | Operating Range | Vol. (µL) | Max Pressure | Qty. | Crimper (Sealer) | Part No. |
|---|-----------------|-----------|--------------|-------|--|------------------|
| ▶ Stainless Steel Pans, Covers and O-rings | -40° to 300 °C | 60 | 24 bar | 20 | B0139005 with B0505340 -or- 09908467 with 03191047 | 03190218 |
| ▶ Stainless Steel Pans, Covers and O-rings | -40° to 300 °C | 60 | 24 bar | 1,000 | B0139005 with B0505340 -or- 09908467 with 03191047 | 03190029 |
| ▶ P20 High Pressure Pans and Covers | -170° to 310 °C | 20 | 100 bar | | 09908467 with 03191047 | L90004786 |
| ▶ High Pressure Stainless Steel Pans, Covers and Seals ¹ | -170° to 300 °C | 30 | 150 bar | 5 | B0182864 | B0182901 |
| ▶ High Pressure Gold-plated Pans and Covers ¹ | -170° to 400 °C | 30 | 150 bar | 5 | B0182864 | B0182902 |
| ▶ High Pressure Titanium Pans, Covers and Seals ² | -170° to 400 °C | 30 | 150 bar | 5 | B0182864 | B0182903 |
| ▶ Aluminum Sample Pans and Covers, High Volume ² | -170° to 500 °C | 70 | 30 bar | 40 | N5356027 or N5356028 | N5356002 |
| ▶ Aluminum Sample Pans and Covers, Small Volume ³ | -170° to 500 °C | 15 | 30 bar | 40 | N5356027 or N5356028 | N5356003 |

¹ Reusable, includes 5 Pans and 20 Gold-plated Seals, uses Replacement Seals (B0182905)

² Reusable, includes 5 Pans and 20 Titanium Seals, uses Replacement Seals (B0185054)

³ Electric Sealer (N5356028) requires Hermetic Die (N5356032) and Stage (N5356035), included with Manual Sealer

Specialty Sample Pans and Covers

| Sample Pan | Operating Range | Vol. (µL) | Max Pressure | Qty. | Crimper (Sealer) | Part No. |
|--|-------------------|-----------|--------------|------|----------------------|-----------------|
| ▶ Alumina Pans and Covers | -170° to 730 °C | 40 | Ambient | 6 | Not Required | N5190180 |
| ▶ Standard Copper Pans and Covers ⁶ | -170° to 730 °C | 40 | Ambient | 200 | 02190048 | 03190026 |
| ▶ Heat Treated Aluminum Pans and Covers | -170° to 600 °C | 40 | Ambient | 100 | Not Required | N5340188 |
| ▶ Graphite Sample Pans and Covers | -170° to 600 °C | 40 | Ambient | 4 | Not Required | 03190025 |
| ▶ Gold Sample Pans and Covers | -170° to 730 °C | 40 | Ambient | 10 | Not Required | 02190042 |
| ▶ Copper Sample Pans ^{4,5,6} | -170° to 800 °C | 45 | Ambient | 200 | Not Required | N5356021 |
| ▶ Aluminum Sample Pans, High Volume ^{2,3} | -170° to 600 °C | 90 | Ambient | 200 | N5356027 or N5356028 | N5356034 |
| ▶ Ceramic Sample Pans ⁷ | RT to 1,500 °C | 25 | Ambient | 5 | Not Required | N5356019 |
| ▶ Ceramic Sample Pans ⁷ | RT to 1,500 °C | 55 | Ambient | 2 | Not Required | N5356020 |
| ▶ Platinum Sample Pans ⁸ | -170° to 1,500 °C | 45 | Ambient | 5 | Not Required | N5356016 |
| ▶ Platinum Sample Pans, High Volume ⁸ | -170° to 1,500 °C | 95 | Ambient | 5 | Not Required | N5356017 |

¹ Not for use with Autosampler ² Cover Crimp style (N5356014). Not for DSC Autosampler, requires Crimping Die and Stage (N5366030)

³ Cover Plate- style (N5356015)

⁴ Copper Mesh Cover (N5356022)

⁵ Stainless Steel Mesh Cover (N5356023)

⁶ Recommended for O.I.T. tests ⁷ No Covers ⁸ Plate Covers (N5356018)

▶ For use with DSC 4000, DSC 6000, DSC 8000, DSC 8500, Diamond DSC, Pyris 1 DSC, DSC 7, DSC 6, Pyris 6 DSC and Jade DSC ▶ For use with Sapphire DSC

Calibration Reference Materials

PerkinElmer reference materials are 99.999% pure. DSC requires elements of this purity so that the instrument can be accurately calibrated.

| Reference Material | Transition Point | Part No. |
|--------------------|------------------|----------|
| Indium | 156.60 °C | 03190033 |
| Tin | 231.88 °C | 03190034 |
| Lead | 327.47 °C | 03190035 |
| Zinc | 419.47 °C | 03190036 |
| Encapsulated Kit* | | 02190045 |
| Encapsulated Kit** | | N5190762 |

* Includes a large and small indium, tin and lead

** Includes indium and zinc for DSC 4000, DSC 6000, DSC 8000, DSC 8500, DSC 7, Pyris 1 DSC, DSC 6, Pyris 6 DSC, Jade DSC and Diamond DSC



Specific Heat Kit

Includes four sapphire disks manufactured to two separate diameters and thicknesses. Also includes a calibration chart giving the specific heat of aluminum oxide in the form of synthetic sapphire.

| Description | Part No. |
|-------------------|----------|
| Specific Heat Kit | 02190136 |

Sample Holder Supplies

Sample Holder Cover Reforming Tool

DSC performance is enhanced with sample holder covers that are formed properly and not degraded by extended usage. This tool allows the analyst to reform the platinum covers to their original dimensions.

| Description | Part No. |
|------------------------------------|----------|
| Sample Holder Cover Reforming Tool | 03190030 |

Platinum Sample Holder Covers

Each cover has two vent holes and is used for the Diamond DSC, Pyris 1 DSC, DSC 7, DSC 8000 and DSC 8500 sample holders.

| Description | Qty. | Part No. |
|-------------------------------|------|----------|
| Vented | 2 | 04190299 |
| Vented | 6 | 03190031 |
| DSC Autosampler, (2 required) | 1 | B0139122 |
| Large furnace covers | 2 | B0182981 |

Sample Holder Cover Reforming Tool



Vented Platinum Sample Holder Cover

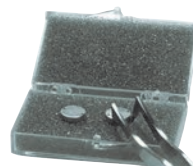

Hook Forceps

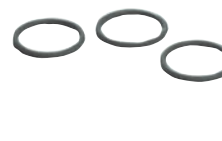

Diamond DSC Loading Tool

Allows for easy insertion and removal of sample or reference pans or platinum lids.

| Description | Part No. |
|--------------------------|----------|
| Diamond DSC Loading Tool | N5361180 |

Forceps

| Description | Part No. |
|-------------------|----------|
| Flat Round Tips | 09908400 |
| Flat Pointed Tips | N5361078 |
| Hook | 09908138 |

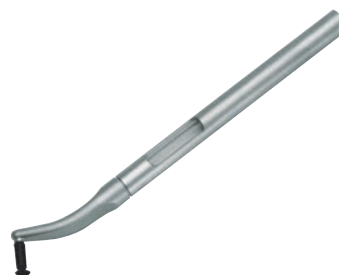

Sample Pan Manipulators

Features and Benefits

- Specially designed to simplify the pickup and positioning of your sample pans and covers.
- Prevents contamination of your sample.

| Description | Part No. |
|---------------------------------|----------|
| Special Sample Pan Manipulator | B0142512 |
| Standard Sample Pan Manipulator | B0143263 |
| Replacement Rubber Tip | N5376097 |

WHEN FAILURE IS NOT AN OPTION



PerkinElmer offers a complete portfolio of consumables, accessories and supplies that deliver optimal performance in measuring the coefficient of thermal expansion (CTE), Tg, and TM in materials. Choose from a range of consumables and accessories with a cost efficient range of probes including expansion, compression, flexure, extension, and volumetric (dilatometry).

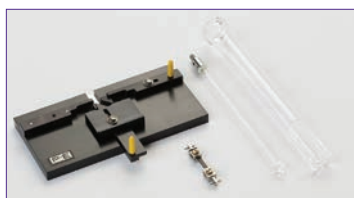

Analysis Kits

Complete sets of all the parts necessary for analysis of samples.

| Description | Part No. |
|-----------------------------|----------|
| TMA Analysis Kit | L8040200 |
| Advanced Analysis Kit | L8040202 |
| Extension Kit | N5190619 |
| Quartz Dilatometer (sm) Kit | 03190461 |

Probes and Sample Tools

Probes

Probes and fixtures for special tests and as replacements of those included in kits.



| Description | Part No. |
|--------------------------------|----------|
| Expansion Probe | N5190378 |
| Extension Probe | N5190609 |
| Flat Tip Penetration Probe | N5190376 |
| Flexure TMA Kit | N5190399 |
| Flexure Probe -3 Point Bending | N5190393 |
| Short Expansion Probe | L8041800 |
| Round Tip Probe - 0.5 mm | N5190377 |
| Round Tip Probe - Large | N5190416 |

Sample Tools and other necessary parts

Complete sets of all the parts necessary for analysis of samples.



| Description | Part No. |
|---------------------------------|----------|
| Aluminum Oxide Powder | 04190197 |
| Bending Anvil | N5391181 |
| Ceramic Furnace Top | L8041808 |
| Copper Film/Fiber Mounting Pins | 02190322 |
| Dilatometer (sm) | 03191705 |
| Extension Tube | N5191700 |
| Extension Sample Clamp | N5190611 |
| Halocarbon Oil 27 | L9004783 |
| Knurled Nut for Sample Tube | N5391054 |
| Quartz Sample Tube | N5191549 |
| Sample Load Fixture | N5190615 |
| Sample Thermocouple | L8041809 |
| Split Collar for Sample Tube | N5191662 |

Reference Materials

Standards for calibration of the TMA.



| Description | Part No. |
|---|----------|
| Aluminum Std Expansion 10mm x 3mm | L8041600 |
| Aluminum Std Expansion 5mm x 3mm | L8041601 |
| Indium Temperature Calibration Material | 03190033 |
| Quartz Displacement Standard | N5391051 |
| Sapphire Disc - Thin Expansion Standard | 02191269 |
| Test and Calibration Weights | L8041801 |
| Zinc Temperature Calibration Material | N5340229 |
| Zinc T-Calibration Standard | 03190036 |

Spares

Useful consumables and accessories you may need to operate your TMA.



| Description | Part No. |
|---------------------------------|----------|
| Non-Magnetic Tweezers | 09908400 |
| Fuses 110V AC | L8041802 |
| Fuses 220V AC | L8041803 |
| Fuses 110/220V AC | L8041804 |
| Hose clamps (4) | 09903004 |
| Tape: High Temperature | 02507907 |
| Tape: Thread Sealant | 09908134 |
| PTFE Tubing: 1/8" OD x 1/16" ID | 02506483 |
| Thermocouple | N5190417 |
| Tygon Tubing: 1/2" OD x 3/8" ID | 02506519 |
| Turbulent Chamber Kit | L8040201 |
| 1/8" Swagelok Fittings (2) | 09903906 |
| Restrictor: Type A | 01541496 |
| Restrictor: Type H | 01541498 |

ACCESSORIES

Furnace Accessories and Glassware

| Description | Standard TGA Part No. | TGA High-Temp. Part No. |
|--|-----------------------|-------------------------|
| Furnace | N5190264 | N5190172 |
| Furnace Thermocouple | | N5190196 |
| Cup for Furnace, Thermocouple | | N5191875 |
| 1 Sample Thermocouple | 03190253 | N5190197 |
| 2 Furnace Tube Quartz TGA 7 | N5190203 | |
| 2 Furnace Tube Quartz PYRIS 1 TGA | N5370459 | N5190202 |
| Platinum Furnace Shield | 03191628 | |
| 4 Balance Tare Weight | N5190282 | N5190284 |
| 5 Cover O-ring | 09902163 | 09902163 |

Furnace Accessories for STA 6000

| Description | Part No. |
|-------------------------|-----------------|
| STA 6000 SaturnA Sensor | N5202083 |

Hangdown Wire Kits



Hangdown Wire Link Kit, Quartz



Hangdown Wire Kit, Nichrome



Stirrup Kit, Platinum

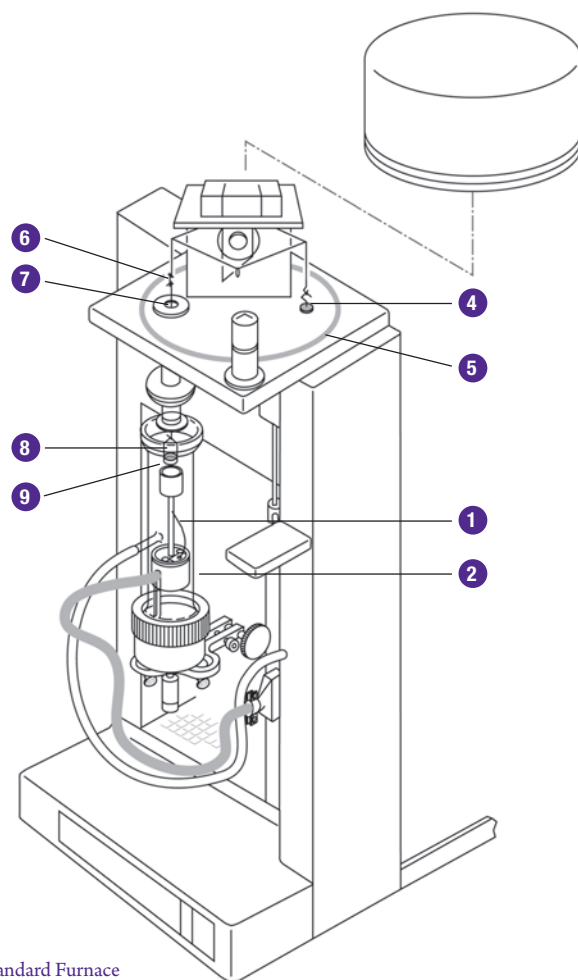

TGA Standard Furnace

| Description | Material | Qty. | TGA 7 Standard Part No. | TGA 7 High-Temp. Part No. | PYRIS 1 TGA Standard Part No. | PYRIS 1 TGA High-Temp. Part No. |
|--|----------|------|-------------------------|---------------------------|-------------------------------|---------------------------------|
| 6 Hangdown Wire Link Kit | Quartz | 10 | N5190330 | | | |
| Hanger Kit | Quartz | 5 | | | N5370487 | |
| Autosampler Hanger Kit | Quartz | 5 | | | N5370488 | |
| 7 Hangdown Wire Kit Includes 6 preformed and 6 straight wires | Nichrome | 6 | N5190285 | | | |
| Hangdown Wire Kit Includes 6 preformed wires | Nichrome | 6 | N5190516 | | | |
| Hangdown Wire Kit Includes 6 straight wires | Nichrome | 6 | N5190515 | | | |
| Hangdown Ribbon | Platinum | 2 | | | N5370478 | N5370478 |
| Autosampler Hanger Kit | Nichrome | 5 | | | N5370490 | |
| 7 Hanger Kit | Platinum | 6 | | | | N5370330 |
| 7 Hangdown Wire Kit Includes 6 preformed wires | Platinum | 6 | | N5190276 | | |
| 8 Stirrup Kit | Platinum | 4 | 03190265 | N5190279 | 03190265 | N5190279 |

Pans for TGA 7 and PYRIS 1 TGA

| Description | Qty | Part No. |
|--|-----|-----------------|
| 9 For TGA 7 Standard/PYRIS 1 TGA | 4 | 03190264 |
| 9 For TGA 7/PYRIS 1 TGA High-temperature | 4 | N5190280 |
| Ceramic Liner Kit for TGA 7/PYRIS 1 TGA | 6 | N5190283 |
| PYRIS 1 TGA Accupik Sample Pans and Covers | 400 | N5370550 |

Pyris 1 TGA Autosampler Ceramic Crucible Kits and Liners

| Description | Part No. |
|---|-----------------|
| Ceramic Crucible Kit. Contains 10 ceramic crucibles. | N5370464 |
| Aluminum Liners for Pyris 1 TGA Autosampler Ceramic Crucibles - Kit of 400 | N5370492 |
| Stainless Steel Liners for Pyris 1 TGA Autosampler Ceramic Crucibles - Kit of 400 | N5370495 |

Pans for STA 6000, STA 8000, and TGA 4000

| Description | Part No. |
|---|-----------------|
| STA 6000/TGA 4000 Ceramic Sample Pan Kit - 45 Pans | N5200045 |
| STA 6000/TGA 4000 Ceramic Sample Pan Kit - 3 Pans | N5200040 |
| STA 6000/TGA 4000 Pt/Rh Pans (2.5 mm height) - 5 Pans | N5201021 |
| STA 6000/TGA 4000 Pt/Rh Pans (5.0 mm height) - 5 Pans | N5201022 |
| STA 6000/TGA 4000 Pt/Rh Pans (2.5 mm height) - 1 Pan | N5201023 |
| STA 6000/TGA 4000 Pt/Rh Pans (5.0 mm height) - 1 Pan | N5201024 |

Pyris 1 TGA Accupik Replacement Needle Kit

Contains 3 needles.

| Description | Part No. |
|--|-----------------|
| Pyris 1 TGA Accupik Replacement Needle Kit | N5370554 |

Pyris 1 TGA Cooling Jacket

With this accessory and a Chiller (optional), the TGA can start from -20 °C.

| Description | Part No. |
|----------------------------|-----------------|
| Pyris 1 TGA Cooling Jacket | N5370553 |

Pyris TGA Volatile Capsule Sealer Kit

| Description | Part No. |
|---------------------------------------|-----------------|
| Pyris TGA Volatile Capsule Sealer Kit | N5370555 |

Forceps, Non-Magnetic

| Description | Part No. |
|-------------|-----------------|
| Hooked | 09908138 |
| Straight | 09908400 |

CALIBRATION REFERENCE MATERIALS

Ensure accurate thermogravimetric measurements with PerkinElmer magnetic reference materials.

| Description | Part No. |
|---|-----------------|
| Kit of Five Reference Materials (Alumel, Nickel, Perkalloy, Iron and Hisat-50)* | 02190071 |
| Alumel Reference Material (154.2°C) | 09988015 |
| Nickel Reference Material (355.3°C) | N5190869 |
| Perkalloy Reference Material (596°C) | N5190616 |
| Iron Reference Material (780°C) | 09988017 |
| Indium Calibration Reference | 03190033 |
| Tin Calibration Reference | 03190034 |
| Lead Calibration Reference | 03190035 |
| Zinc Calibration Reference | 03190036 |
| Silver Calibration Reference | N5370438 |
| Calibration Weight (TGA 6, TGA 4000, STA 6000) | N5200042 |
| Calibration Weight (100 mg) | 09908397 |
| Calibration Weight Standards Kit for NOACK Lubricating Oil Test** | N5370140 |

* Magnetic Calibration Reference Materials are available in kit form and now are also available separately for your convenience. We recommend that you use fresh reference materials each time you calibrate your instruments. In this way you can avoid the effects of hysteresis and oxidation on the Curie point of the reference materials.

** Used to calibrate a TGA or STA to perform ASTM test method D5800 for evaporation loss of lubricating oils by the NOACK method.

COMPLETE RANGE OF ACCESSORIES

Cost effective Dynamic Mechanical Analyzer supplies for routine quality testing in the polymers, composites, pharmaceutical and food industries.

REPLACEMENT PARTS FOR THE DMA 8000

The DMA 8000 comes with a complete set of standard fixtures to allow tension, bending (3 type), shear and compression experiments.

| Description | Part No. |
|---|----------|
| Bending Clamp Set | N5330300 |
| Shear Studs and Plate Set | N5330301 |
| Shear Clamp Outer Assembly (pair) | N5330302 |
| 3 Point Bend Assembly | N5330305 |
| Outer Clamp Supports – Stainless (pair) | N5330303 |
| Outer Clamp Support – Single Side Only | N5330304 |
| Extended Bending Clamp Set | N5330308 |
| Compression Insert | N5330309 |
| Extended Bending Clamp Set | N5330306 |
| Miniature 3 Point Bending Clamp | N5330307 |
| Extended Nut Set | N5330310 |
| Full Nut Set | N5330311 |
| Tensile Spacer Set | N5330313 |
| Tensile Clamps (Titanium) | N5330312 |
| Alignment Fixture | N5330314 |



Replaceable Parts For DMA 8000 Systems

| Description | Part No. |
|--|----------|
| Pt 100 Replacement Sensor | N5330253 |
| Pyrex® Cup for Fluid Bath (set of 3) | N5330320 |
| Screw set (4) | N5330338 |
| Side Pillars and Screw | N5330303 |
| Insert Compression (titanium) | N5330308 |
| Replacement Omnicure® Light Pipe | N5365048 |
| Replacement Omnicure® Bulb | N5365049 |
| End cap for DMA 8000 Vent Cover | N5337031 |
| Desiccant for Humidity Chamber (1 kg) | N5330405 |
| Humidity Generator Sensor – calibrated | N5330402 |
| Humidity Generator Heated Line | N5330403 |
| Humidity Generator Sensor Lead | N5330404 |
| Rod Microswitch Extension | N5331098 |

Calibration Supplies

| Description | Part No. |
|---|----------|
| PMMA Test Sample (set of 5) | N5330316 |
| Steel Test Sample | N5330317 |
| PVC Test Sample (set of 5) | N5330340 |
| HDPE Test Sample (set of 5) | N5330341 |
| Polycarbonate Test Sample (set of 5) | N5330342 |
| PET Film Test Sample (set of 5) | N5330343 |
| G10 Epoxy Test Sample (set of 5) | N5330344 |
| Septum for compression (Set of 5) | 00090652 |
| Calibration Mass | N5330315 |
| Temperature Calibration Kit Includes indium wire (1.5 mm dia), PMMA test sample (5) and FEB tube. | N5330318 |
| Traceable Calibration Kit, DMA Testing Kit Includes micrometer caliper, calibration mass, PMMA test sample kit (5) feeler gauge, indium wire sample (2) and PTFE tube. | N5330319 |
| Measuring System Training Kit Includes training manual, fairprene septum kit, acrylic sample (5), PVC sample (5), HDPE sample (5), polycarb sample (5), PET sample (5) and G10 sample (5). | N5330220 |
| Dynamic Mechanical Analysis: A Practical Introduction (Menard) | N5374092 |

Cooling Accessories

The DMA 8000 has two options for sub-ambient operation: a 1-Liter Dewar for those needing occasional cooling, and a 50 L Dewar for those requiring longer or more frequent sub-ambient experiments.

| Description | Size | Part No. |
|--|------|-----------------|
| LN2 Cryo Dewar with Transfer Line and Fittings | 1 L | N5330254 |
| LN2 Cryo Dewar with Transfer Line and Fittings | 50 L | N5373009 |



Material Pockets

Specialty Fixtures and Accessories

Special problems often require special tools and a wide range of options exist for the DMA 8000. Advanced software for special tasks, clamps for tablets, material pockets, photo-adapter for UV studies and fixtures that allow you to use the DMA 7 fixtures in the DMA 8000 are all available.

| Description | Package | Part No. |
|--|--------------|-----------------|
| Measuring System for Tablets For holding non-flat tablets, capsules and pills in compression. Can be used with the fluid bath or the humidity chamber as well as the standard furnace. One side is V-grooved and the other side has a round groove to allow a wide range of specimens to be held. | | N5330604 |
| Material Pockets For running pharmaceuticals, powders and other non-self supporting samples. | Set of 10 | N5330322 |
| | Set of 100 | N5330323 |
| | Set of 1,000 | N5330324 |
| Mesh Pockets For running pharmaceuticals, paints and other non-supporting samples where letting moisture and solvent in and out is desirable. | Set of 25 | N5330177 |
| | Set of 100 | N5330178 |
| DMA 7e Fixture Adapter Allows use of DMA 7 fixtures in DMA 8000. | | N5330613 |
| DMA Photo Adapter Allows use of DSC UV system light guides with DMA 8000. | | N5337024 |
| Fluid Bath Accessory* Allows immersion of samples. | | N5330262 |
| Humidity Generator** Allows testing in controlled relative humidity. | | N5330400 |
| Upgrade to Pyris SW Version 11 Controls the DMA8000 from within Pyris SW and includes TTS and Stress Relaxation. | | N5340090 |

* Required for routine humidity work with Humidity Generator (N5330400).

** Requires Fluid Bath Accessory (N5330262).



Prepacked Tubes

| Description | Est. Runs* | Part No. |
|-------------------------------|------------|-----------------|
| CHN Oxidation Tube | 1000* | N2410695 |
| CHN Reduction Tube | 150-180* | N2410694 |
| CHNS Oxidation/Reduction Tube | 120* | N2410693 |
| O Pyrolysis Tube | 1000* | N2410696 |
| Scrubbing Tube (Argon Sealed) | 250* | N2410697 |
| CHNS/Oxygen Reduction Furnace | N/A | N2410698 |

*Estimated runs derived by PerkinElmer under ideal conditions, actual customer runs may vary.

Tubes

| Description | Part No. |
|---|-----------------|
| 2400 CHN Kit | |
| Combustion and Reduction Tube and Reagent Kits and Tin Capsules. Quartz wool not included. | N2410683 |
| 2400 CHNS Kit | |
| Combustion/Reduction Tube, Reagent Kits and Tin Capsules. Quartz wool not included. | N2410684 |
| CHN Prepacked Tube Kit | |
| One prepacked combustion tube and 3 prepacked combustion tubes. | N2410506 |
| CHNS Prepacked Tube Kit | |
| Four prepacked CHNS combustion tube and a prepacked reduction furnace tube. | N2410507 |
| O Prepacked Tube Kit | |
| One prepacked O combustion tube, 1 prepacked reduction furnace tube, and 4 prepacked scrubbing tubes. | N2410513 |
| 2400/2410 Maintenance Kit | |
| Includes O-Rings, Washers, Fuses and Springs Required for Routine Maintenance of the 2400 or 2410 Elemental Analyzers | N2410152 |

Packing Supplies

| Description | Part No. |
|------------------------------|-----------------|
| Silver Gauze Strip (Pkg 1) | N2410145 |
| Platinum Gauze Strip (Pkg 1) | N2411273 |
| Quartz Wool, (50 g)* | 02401118 |
| Copper Diffusion Plug, each | N2411333 |

*Only sold in the US due to export restrictions.

Calibration Standards

| Description | Size | Part No. |
|---------------|-------|-----------------|
| Acetanilide | 2 g | 02401121 |
| Benzoic Acid | 4 g | 02401120 |
| Cystine | 4 g | N2410324 |
| EDTA | 100 g | N2410325 |
| Sulfamic Acid | 10 g | N2410501 |



PerkinElmer genuine reagents will assure consistent and accurate results.

Reagents

| Description | Part No. |
|---|-----------------|
| EA-1000, (50 g) | N2410092 |
| EA-1000, (3 x 50 g) | N2410166 |
| Silver Tungstate/Magnesium Oxide, (100 g) | 02401344 |
| Silver Tungstate/Magnesium Oxide, (3 x 100 g) | N2410165 |
| Silver Vanadate, (40 g) | 02401117 |
| Silver Vanadate, (3 x 40 g) | N2410164 |
| EA-6000, (50 g) | N2410278 |
| EA-6000, (5 x 50 g) | N2410331 |
| Platinized Carbon, (10 g) | 02400119 |
| Copper Plus, (454 g) | 02400117 |
| Copper Plus, (10 x 454 g) | N2410157 |
| Copper Plus – Wire Form, (454 g) | 02401362 |
| Copper Plus – Wire Form, (5 x 454 g) | N2410332 |
| Copper for Nitrogen, (454 g) | N2411527 |
| Copper for Nitrogen, (10 x 454 g) | N2410518 |
| Copper Oxide – Wire Form, (454 g) | 02401092 |
| Aquasorb, (25 g) | N2410277 |
| Colorcarb, (100 g) | 02400115 |
| Colorcarb, (3 x 100 g) | N2410188 |
| Magnesium Perchlorate, (454 g) | 02401119 |
| Magnesium Perchlorate, (3 x 454 g) | N2410191 |
| Thermolite, (100 g) | 02400815 |

Receptacles

| Description | Qty. | Part No. |
|--|------|-----------------|
| Quartz Tube Insert | 1 | N2411401 |
| Vial Receptacle, Metal (CHN Mode and 2410) | 1 | N2411335 |
| Vial Receptacle, Metal (CHNS and Oxygen Modes) | 10 | N2410177 |
| Vial Receptacle, Ceramic | 1 | 09904866 |
| Zirconia Cloth | 1 | N2410168 |

Sample Capsules and Sealers

Tin Capsules

For analysis of nonvolatile solid samples.

| Description | Dims. | Qty. | Part No. |
|-------------------------------------|--------------|------|-----------------|
| Standard Tin Capsule Kit | 5 mm x 7 mm | 96 | N2411255 |
| Standard Tin Capsule Kit, (pkg. 10) | 5 mm x 7 mm | 960 | N2410155 |
| Large Tin Capsule Kit | 7 mm x 14 mm | 250 | N2411362 |

Flat Tin Disks

For analyzing 13 or 25 mm filters.

| Description | Qty. | Part No. |
|---------------------------|------|-----------------|
| Flat Tin Disks | 100 | N2411363 |
| Flat Tin Disks, (pkg. 10) | 1000 | N2410244 |

Aluminum Capsules

For analyzing volatile liquid samples. Requires, but does not include, Liquid Sample Sealer (B0198093) and Tin Capsules.

| Description | Qty. | Part No. |
|-------------------------------|-------|-----------------|
| Aluminum Capsules, 4 μ L | 1,000 | 02400642 |
| Aluminum Capsules, 30 μ L | 1,000 | 00090709 |

Tin Pans and Covers

For volatile liquid or solid samples, including viscous materials. Requires, but does not include, Volatile Sample Sealer (02190061).

| Description | Qty. | Part No. |
|-------------------------------------|------|-----------------|
| Volatile Tin Sample Pans and Covers | 400 | N2410320 |

Silver Capsules

For analyzing organic substances with Oxygen Analysis.

| Description | Qty. | Part No. |
|-----------------|------|-----------------|
| Silver Capsules | 96 | N2411364 |

Sample Sealers

For use with volatile, nonviscous, noncorrosive samples.

| Description | Part No. |
|---|-----------------|
| Liquid Sample Sealer | B0198093 |
| Spare Magazine for Liquid Sample Sealer | B0501078 |
| Volatile Sample Sealer | 02190061 |



Combustion and Pyrolysis Tubes

Tubes

PerkinElmer tubes are composed of pure fused quartz which is 99% SiO₂. Fused quartz has been chosen because of its very high purity and low thermal expansion rate. Because we care about your safety, all combustion tubes are pressure-tested to eliminate any tubes which might contain weak spots. In addition, stringent specifications are used to ensure that the combustion tubes fit in an airtight connection when placed in the analyzer.

| Type | Material | Analyzer | Mode | Qty. | Part No. |
|--------------------------|--------------------|---------------|----------------------|------|-----------------|
| Combustion | Quartz | 2400 | CHN | 1 | N2411264 |
| Combustion | Quartz | 2400 | CHN | 3 | N2410212 |
| Combustion | Quartz | 2400 | CHN | 10 | N2410153 |
| Combustion/ Reduction | Quartz | 2400 | CHNS | 1 | N2411514 |
| Combustion/ Reduction | Quartz | 2400 | CHNS | 5 | N2410330 |
| Combustion/ Reduction | Stainless Steel | 2410 | Nitrogen | 1 | N2421070 |
| Pyrolysis | Quartz | 2400 | Oxygen | 1 | N2411235 |
| Reduction | Quartz | 2400 | Oxygen & Sulfur | 1 | N2411300 |
| Reduction | Quartz | 2400 | CHN | 1 | N2411291 |
| Reduction | Quartz | 2400 | CHN | 10 | N2410154 |
| Scrubber | Pyrex® | 2400/ 2410 | Oxygen & Nitrogen | 1 | N2411359 |

PART NUMBER INDEX

| Part No. | Page | Part No. | Page | Part No. | Page |
|----------|------------------------------|----------|----------|----------|----------|
| 00080100 | 207, 214, 216, 217, 218, 220 | 02190071 | 295 | 02542911 | 100 |
| 00090652 | 213, 296 | 02190136 | 292 | 02542912 | 100 |
| 00090699 | 117, 121 | 02190322 | 293 | 02542913 | 100 |
| 00090709 | 299 | 02191269 | 293 | 02542914 | 100 |
| 00091279 | 215 | 02192005 | 290 | 02542915 | 100 |
| 00091357 | 116 | 02200550 | 258 | 02542916 | 100 |
| 00091667 | 217 | 02400115 | 298 | 02542917 | 100 |
| 00230090 | 157, 241 | 02400117 | 298 | 02542918 | 100 |
| 00230091 | 241 | 02400119 | 298 | 02542919 | 100 |
| 00230111 | 112 | 02400642 | 299 | 02542920 | 100 |
| 00230177 | 112 | 02400815 | 298 | 02542921 | 100 |
| 00230178 | 112 | 02401092 | 298 | 02542922 | 100 |
| 00230253 | 241 | 02401117 | 298 | 02542923 | 100 |
| 00230522 | 243 | 02401118 | 298 | 02542924 | 100 |
| 00230523 | 212 | 02401119 | 298 | 02542925 | 100 |
| 00402237 | 152 | 02401120 | 298 | 02542926 | 100 |
| 00402239 | 148 | 02401121 | 298 | 02542927 | 100 |
| 00402240 | 148 | 02401344 | 298 | 02542928 | 100 |
| 00402241 | 148 | 02401362 | 298 | 02542929 | 100 |
| 00402243 | 148 | 02506483 | 157, 293 | 02580164 | 147 |
| 00403053 | 148 | 02506495 | 59, 164 | 02580166 | 147 |
| 00470258 | 90 | 02506516 | 41, 58 | 02580168 | 147 |
| 00470988 | 21 | 02506519 | 293 | 02580169 | 147 |
| 00472014 | 21 | 02507060 | 168 | 02580178 | 160, 165 |
| 00472020 | 34 | 02507907 | 293 | 02580191 | 147 |
| 00472022 | 34, 41 | 02507987 | 21 | 02580192 | 147 |
| 00473292 | 54 | 02508080 | 60 | 02580194 | 147 |
| 00473550 | 60 | 02509115 | 91 | 02580195 | 147 |
| 00473552 | 60 | 02540154 | 158 | 02580202 | 147, 165 |
| 00570559 | 90 | 02540177 | 158 | 02580203 | 147 |
| 00570567 | 90 | 02540197 | 158 | 02580204 | 147 |
| 00570948 | 21 | 02540272 | 160 | 02580213 | 147 |
| 00570984 | 21, 24 | 02540274 | 162 | 02580223 | 165 |
| 00572561 | 21 | 02540276 | 158 | 02580225 | 153 |
| 00572615 | 24 | 02540311 | 160 | 02711441 | 161 |
| 00572624 | 21 | 02540838 | 161 | 02712266 | 155 |
| 00873032 | 162, 168 | 02540871 | 160 | 02712273 | 155 |
| 00873035 | 161 | 02542076 | 158 | 02900540 | 73 |
| 00873036 | 161 | 02542313 | 158 | 03030106 | 90 |
| 00890873 | 162 | 02542783 | 100 | 03030133 | 25 |
| 00890893 | 152 | 02542880 | 100 | 03030135 | 25 |
| 00890945 | 162 | 02542881 | 100 | 03030204 | 90 |
| 00891480 | 161, 168 | 02542882 | 100 | 03030264 | 90 |
| 00891542 | 152 | 02542883 | 100 | 03030284 | 90 |
| 00891543 | 152 | 02542884 | 100 | 03030299 | 24 |
| 00891544 | 152 | 02542885 | 100 | 03030349 | 90 |
| 00903094 | 58 | 02542886 | 100 | 03030352 | 24 |
| 01541496 | 293 | 02542890 | 112 | 03030354 | 24, 25 |
| 01541498 | 293 | 02542891 | 112 | 03030402 | 24, 25 |
| 01860436 | 261 | 02542892 | 112 | 03030404 | 24 |
| 01860796 | 255 | 02542893 | 112 | 03030405 | 25 |
| 01860954 | 255 | 02542900 | 100 | 03030433 | 24 |
| 01862289 | 261 | 02542901 | 100 | 03030447 | 90 |
| 01862292 | 261 | 02542902 | 100 | 03030448 | 90 |
| 01862295 | 261 | 02542903 | 100 | 03030793 | 17 |
| 01862301 | 265 | 02542904 | 100 | 03030997 | 17 |
| 02190041 | 290 | 02542905 | 100 | 03030998 | 17 |
| 02190042 | 291 | 02542906 | 100 | 03031573 | 21 |
| 02190045 | 292 | 02542907 | 100 | 03031573 | 21 |
| 02190048 | 290 | 02542908 | 100 | 03031806 | 24 |
| 02190061 | 299 | 02542909 | 100 | 03190025 | 291 |
| 02190062 | 290 | 02542910 | 100 | 03190026 | 291 |

| Part No. | Page | Part No. | Page | Part No. | Page |
|----------|---------------|----------|----------|----------|----------|
| 03190029 | 291 | 07110013 | 146 | 07110165 | 149 |
| 03190030 | 292 | 07110014 | 146 | 07110166 | 149 |
| 03190031 | 292 | 07110015 | 146 | 07110189 | 151 |
| 03190033 | 292, 293, 295 | 07110016 | 146 | 07110190 | 151 |
| 03190034 | 292, 295 | 07110017 | 146 | 07110191 | 151 |
| 03190035 | 292, 295 | 07110018 | 146 | 07110192 | 151 |
| 03190036 | 292, 293, 295 | 07110019 | 146 | 07110231 | 135, 145 |
| 03190218 | 291 | 07110020 | 146 | 07110232 | 135, 145 |
| 03190253 | 294 | 07110021 | 146 | 07110233 | 135, 145 |
| 03190264 | 295 | 07110022 | 146 | 07110234 | 135, 145 |
| 03190265 | 294 | 07110023 | 146 | 07110235 | 135, 145 |
| 03190461 | 293 | 07110024 | 146 | 07110236 | 135, 145 |
| 03191047 | 291 | 07110025 | 146 | 07120001 | 141 |
| 03191628 | 294 | 07110027 | 146 | 07120005 | 141 |
| 03191705 | 293 | 07110028 | 146 | 07120012 | 141 |
| 03300806 | 116 | 07110029 | 146 | 07120016 | 141 |
| 03300865 | 219 | 07110031 | 146 | 07120019 | 141 |
| 03300866 | 219 | 07110032 | 146 | 07120023 | 141 |
| 03300904 | 204 | 07110033 | 146 | 07120033 | 135 |
| 03300905 | 207 | 07110034 | 146 | 07120040 | 135 |
| 03302775 | 219 | 07110037 | 146 | 07120043 | 135 |
| 03302777 | 219 | 07110039 | 146 | 07120070 | 135 |
| 03302778 | 219 | 07110041 | 146 | 07120073 | 135 |
| 03302973 | 219 | 07110042 | 146 | 07120096 | 135 |
| 03302976 | 219 | 07110043 | 146 | 07120097 | 135 |
| 03302979 | 219 | 07110044 | 146 | 07120099 | 135 |
| 03302989 | 219 | 07110045 | 146 | 07150001 | 153 |
| 03303598 | 219 | 07110046 | 146 | 07150002 | 153 |
| 03303599 | 219 | 07110047 | 146 | 07150005 | 153 |
| 03303773 | 219 | 07110055 | 135, 145 | 07150006 | 153 |
| 04190197 | 207, 293 | 07110056 | 135, 145 | 07150012 | 152 |
| 04190299 | 292 | 07110057 | 135, 145 | 07150013 | 153 |
| 04800514 | 261 | 07110058 | 135, 145 | 07150014 | 153 |
| 04810949 | 261 | 07110059 | 135, 145 | 07150015 | 153 |
| 04820519 | 261 | 07110060 | 135, 145 | 07150016 | 153 |
| 04821008 | 257 | 07110061 | 145 | 07150017 | 153 |
| 04821131 | 257 | 07110062 | 145 | 07150018 | 153 |
| 04821132 | 257 | 07110064 | 145 | 07150019 | 153 |
| 04960691 | 265 | 07110066 | 145 | 07150020 | 153 |
| 04967843 | 265 | 07110073 | 135, 145 | 07150021 | 153 |
| 04967845 | 258, 265 | 07110074 | 135, 145 | 07150022 | 153 |
| 04967854 | 265 | 07110075 | 135, 145 | 07150023 | 152 |
| 04969486 | 155, 286 | 07110076 | 135, 145 | 07150024 | 152 |
| 04970673 | 225 | 07110077 | 135, 145 | 07150025 | 153 |
| 04977042 | 261 | 07110085 | 149 | 07150026 | 152 |
| 04977043 | 261, 265 | 07110086 | 152 | 07150028 | 153 |
| 04978064 | 225 | 07110087 | 149 | 07150029 | 153 |
| 04978499 | 284 | 07110088 | 152 | 07150030 | 153 |
| 04978532 | 116 | 07110089 | 149 | 07150031 | 153 |
| 5085685 | 262 | 07110090 | 152 | 07150032 | 153 |
| 6008103 | 262 | 07110091 | 149 | 07607537 | 262 |
| 6008104 | 262 | 07110092 | 152 | 09200064 | 45 |
| 7002356 | 262 | 07110093 | 149 | 09200078 | 42 |
| 7005386 | 262 | 07110095 | 149 | 09200079 | 25 |
| 7005397 | 262 | 07110096 | 152 | 09200091 | 225 |
| 7005398 | 262 | 07110098 | 152 | 09200122 | 21, 25 |
| 07110001 | 146 | 07110100 | 152 | 09200253 | 21, 25 |
| 07110002 | 146 | 07110102 | 152 | 09200271 | 25 |
| 07110003 | 146 | 07110105 | 152 | 09200272 | 25 |
| 07110004 | 146 | 07110106 | 152 | 09200273 | 25 |
| 07110005 | 146 | 07110114 | 149 | 09200274 | 25 |
| 07110006 | 146 | 07110163 | 149 | 09200275 | 25 |

PART NUMBER INDEX

| Part No. | Page | Part No. | Page | Part No. | Page |
|----------|---------------|----------|---------------|----------|--------|
| 09200276 | 25 | 09904941 | 165, 212, 213 | 09923464 | 91 |
| 09200277 | 25 | 09904943 | 165, 213 | 09923517 | 91 |
| 09200278 | 25 | 09904947 | 162, 168 | 09923536 | 60 |
| 09200369 | 25 | 09904956 | 162, 168 | 09926070 | 42 |
| 09210011 | 51, 54, 55 | 09904974 | 162, 168 | 09926083 | 25 |
| 09210012 | 54, 55 | 09904991 | 21, 25, 38 | 09926126 | 24 |
| 09220102 | 160 | 09905147 | 56 | 09926127 | 25 |
| 09220120 | 122 | 09907120 | 91 | 09938910 | 160 |
| 09220122 | 122 | 09907126 | 154 | 09972321 | 216 |
| 09410105 | 123 | 09907127 | 241 | 09985708 | 37, 48 |
| 09902005 | 24, 25 | 09907128 | 241 | 09985723 | 48 |
| 09902006 | 42 | 09907233 | 168 | 09988015 | 295 |
| 09902015 | 24, 25, 42 | 09907338 | 158 | 09988017 | 295 |
| 09902018 | 158 | 09907339 | 158 | 09989859 | 45 |
| 09902033 | 48 | 09907345 | 158 | 09992731 | 45 |
| 09902045 | 42 | 09907827 | 214 | 09995097 | 91 |
| 09902102 | 25 | 09907925 | 29 | 09995098 | 91 |
| 09902123 | 57, 59 | 09908134 | 293 | 10070900 | 163 |
| 09902128 | 158 | 09908138 | 292, 295 | 29000542 | 154 |
| 09902131 | 42 | 09908265 | 24, 25, 37 | 29000544 | 154 |
| 09902143 | 45, 214 | 09908324 | 158 | 29000545 | 154 |
| 09902147 | 21, 25 | 09908397 | 295 | 51000634 | 259 |
| 09902155 | 45 | 09908400 | 292, 293, 295 | 51000636 | 259 |
| 09902163 | 294 | 09908467 | 291 | 51000638 | 259 |
| 09902207 | 41, 42 | 09908585 | 58, 60 | 51000817 | 259 |
| 09902219 | 21 | 09908587 | 60 | 51001135 | 257 |
| 09902223 | 42 | 09908851 | 225 | 51001137 | 257 |
| 09902236 | 21 | 09919737 | 59 | 51001140 | 257 |
| 09902239 | 24, 25 | 09920104 | 200, 207, 228 | 51001141 | 257 |
| 09902240 | 21 | 09920105 | 200, 204, 228 | 51001144 | 261 |
| 09902247 | 42, 216 | 09920107 | 200 | 51001148 | 261 |
| 09902473 | 24 | 09920127 | 228 | 51001149 | 261 |
| 09903004 | 293 | 09920140 | 204 | 51001152 | 261 |
| 09903094 | 41, 58 | 09920141 | 200 | 51001188 | 256 |
| 09903128 | 209 | 09920301 | 204, 209 | 51001324 | 256 |
| 09903150 | 41 | 09920381 | 162, 168 | 51001325 | 256 |
| 09903289 | 162, 168 | 09920382 | 162, 168 | 51001326 | 256 |
| 09903392 | 204, 209 | 09920483 | 24 | 51001327 | 256 |
| 09903394 | 200 | 09920513 | 168 | 51001328 | 256 |
| 09903395 | 200 | 09920515 | 48 | 51001329 | 256 |
| 09903456 | 58 | 09920518 | 48 | 51002592 | 261 |
| 09903464 | 58 | 09921004 | 207, 209 | 51002593 | 261 |
| 09903465 | 58 | 09921028 | 41, 42 | 51004599 | 261 |
| 09903606 | 160 | 09921036 | 45 | 52019600 | 286 |
| 09903610 | 160 | 09921044 | 21 | 52123130 | 289 |
| 09903615 | 160 | 09921045 | 37, 48 | 52123164 | 289 |
| 09903700 | 200 | 09921057 | 45 | 52123814 | 289 |
| 09903771 | 157, 162, 168 | 09921061 | 42 | 52126027 | 287 |
| 09903891 | 162, 168 | 09921062 | 42, 45 | 54120790 | 225 |
| 09903906 | 157, 293 | 09923031 | 114 | B0017041 | 283 |
| 09903980 | 162, 168 | 09923032 | 114 | B0017047 | 283 |
| 09903981 | 200 | 09923037 | 60 | B0017052 | 283 |
| 09904800 | 166 | 09923078 | 214 | B0017054 | 283 |
| 09904802 | 163, 166 | 09923219 | 168 | B0017057 | 283 |
| 09904805 | 166 | 09923270 | 168 | B0017059 | 283 |
| 09904822 | 165, 213 | 09923304 | 168 | B0017998 | 67 |
| 09904823 | 165, 212, 213 | 09923305 | 168 | B0018283 | 64, 67 |
| 09904845 | 91 | 09923306 | 168 | B0022087 | 283 |
| 09904846 | 91 | 09923307 | 168 | B0023363 | 283 |
| 09904849 | 160, 165, 168 | 09923366 | 158 | B0023491 | 283 |
| 09904866 | 298 | 09923367 | 158 | B0023492 | 283 |
| 09904937 | 165, 213 | 09923448 | 60 | B0029792 | 67 |

| Part No. | Page | Part No. | Page | Part No. | Page |
|----------|----------|----------|------------|----------|----------|
| B0029796 | 67 | B0143020 | 290 | B0501078 | 299 |
| B0038137 | 119 | B0143021 | 290 | B0501236 | 29 |
| B0041693 | 283 | B0143263 | 292 | B0501282 | 281 |
| B0041695 | 283 | B0144169 | 228 | B0501315 | 67 |
| B0041696 | 283 | B0152471 | 275 | B0501377 | 120 |
| B0046948 | 67 | B0159356 | 119 | B0501580 | 66 |
| B0048139 | 64, 67 | B0159357 | 119 | B0501594 | 67 |
| B0062666 | 283 | B0165332 | 24 | B0501595 | 67 |
| B0066549 | 66 | B0169319 | 290 | B0501696 | 91 |
| B0070126 | 67 | B0169320 | 290 | B0502706 | 91 |
| B0070699 | 30 | B0169321 | 290 | B0503956 | 228 |
| B0071519 | 279 | B0169322 | 290 | B0504033 | 28 |
| B0080259 | 31 | B0172053 | 63 | B0504035 | 29 |
| B0080819 | 278 | B0174378 | 24 | B0504036 | 29 |
| B0080821 | 275 | B0181091 | 290 | B0505057 | 30 |
| B0080822 | 275 | B0182864 | 291 | B0505071 | 275 |
| B0086703 | 279 | B0182901 | 291 | B0505086 | 24 |
| B0087056 | 26 | B0182902 | 291 | B0505284 | 281 |
| B0087600 | 26 | B0182903 | 291 | B0505480 | 24 |
| B0091504 | 30 | B0182981 | 292 | B0505530 | 280, 281 |
| B0094404 | 283 | B0185210 | 276 | B0505590 | 24 |
| B0098799 | 283 | B0185227 | 278 | B0505677 | 167 |
| B0098800 | 283 | B0187028 | 277 | B0505983 | 24 |
| B0099814 | 119 | B0187258 | 67 | B0506058 | 62, 67 |
| B0101164 | 26 | B0190634 | 29, 31, 73 | B0506060 | 67 |
| B0102332 | 26 | B0190635 | 29, 31, 73 | B0506143 | 24 |
| B0104236 | 118 | B0190672 | 24 | B0506716 | 66 |
| B0104239 | 119, 120 | B0191058 | 67 | B0506722 | 29 |
| B0104240 | 119 | B0191059 | 67 | B0506737 | 62 |
| B0104241 | 119, 120 | B0191060 | 63, 62, 67 | B0507020 | 67 |
| B0104242 | 119 | B0193161 | 62, 67 | B0507021 | 67 |
| B0104243 | 119, 120 | B0193233 | 65 | B0507226 | 73 |
| B0104244 | 119 | B0193234 | 65 | B0507403 | 283 |
| B0104281 | 26 | B0193235 | 65 | B0507447 | 283 |
| B0104344 | 26 | B0193342 | 66 | B0507451 | 283 |
| B0105197 | 30 | B0193772 | 67 | B0507486 | 66 |
| B0105973 | 26 | B0193873 | 66 | B0507487 | 66 |
| B0105974 | 26 | B0194048 | 67 | B0507692 | 62, 67 |
| B0110728 | 119 | B0194049 | 67 | B0507805 | 269 |
| B0114620 | 268 | B0196704 | 66 | B0507918 | 66 |
| B0119079 | 26 | B0196850 | 66 | B0507919 | 64, 66 |
| B0121092 | 30 | B0196857 | 66 | B0507920 | 66 |
| B0128495 | 31 | B0196858 | 290 | B0507921 | 66 |
| B0129258 | 26 | B0196882 | 66 | B0507949 | 66 |
| B0129303 | 26 | B0196912 | 282 | B0507957 | 67 |
| B0131186 | 283 | B0198005 | 29 | B0507959 | 67 |
| B0131385 | 228 | B0198030 | 290 | B0507962 | 67 |
| B0132799 | 26 | B0198093 | 299 | B0508306 | 67 |
| B0135653 | 30 | B0198097 | 67 | B0508310 | 62, 67 |
| B0137111 | 30 | B0198099 | 67 | B0508520 | 64 |
| B0137113 | 30 | B0198100 | 67 | B0508901 | 65, 262 |
| B0137314 | 279 | B0198110 | 120, 228 | B0509065 | 29 |
| B0139005 | 290 | B0198201 | 66 | B0509479 | 67 |
| B0139122 | 292 | B0199034 | 62, 67 | B0509546 | 282 |
| B0142512 | 292 | B0199035 | 66 | B0509554 | 64 |
| B0143003 | 290 | B0199233 | 58, 66 | B0509555 | 64 |
| B0143004 | 290 | B0500748 | 29 | B0509591 | 282 |
| B0143015 | 290 | B0500833 | 120, 228 | B0509612 | 67 |
| B0143016 | 290 | B0500952 | 275 | B0510032 | 67 |
| B0143017 | 290 | B0500959 | 228 | B0510334 | 66 |
| B0143018 | 290 | B0500987 | 228 | B0510364 | 228 |
| B0143019 | 290 | B0501000 | 67 | B0510366 | 277 |
| | | B0501056 | 64 | | |

PART NUMBER INDEX

| Part No. | Page | Part No. | Page | Part No. | Page |
|----------|------|----------|------|----------|--------|
| B0510370 | 66 | B0631084 | 273 | B3000132 | 64 |
| B0510397 | 26 | B0631085 | 273 | B3000133 | 64 |
| B0510398 | 26 | B0631087 | 273 | B3000135 | 64 |
| B0510412 | 277 | B0631088 | 273 | B3000151 | 63 |
| B0510581 | 283 | B0631089 | 273 | B3000152 | 63 |
| B0510800 | 290 | B0631090 | 273 | B3000157 | 63 |
| B0631001 | 270 | B0631091 | 273 | B3000158 | 63 |
| B0631002 | 270 | B0631092 | 273 | B3000159 | 63 |
| B0631003 | 270 | B0631093 | 273 | B3000160 | 63 |
| B0631004 | 270 | B0631094 | 273 | B3000161 | 63 |
| B0631005 | 270 | B0631095 | 273 | B3000243 | 66 |
| B0631006 | 270 | B0631096 | 273 | B3000274 | 66 |
| B0631007 | 270 | B0631097 | 273 | B3000342 | 30 |
| B0631008 | 270 | B0631098 | 273 | B3000641 | 28 |
| B0631009 | 270 | B0631099 | 273 | B3000653 | 28 |
| B0631010 | 270 | B0631100 | 273 | B3000655 | 28 |
| B0631011 | 270 | B0631101 | 273 | B3001253 | 30 |
| B0631012 | 270 | B0631102 | 273 | B3001254 | 30 |
| B0631013 | 270 | B0631104 | 284 | B3001256 | 31 |
| B0631014 | 270 | B0631107 | 284 | B3001262 | 30 |
| B0631015 | 270 | B0631110 | 284 | B3001264 | 30 |
| B0631016 | 270 | B0631113 | 284 | B3001485 | 26 |
| B0631017 | 270 | B0631115 | 284 | B3001505 | 26 |
| B0631018 | 270 | B0631116 | 284 | B3001506 | 26 |
| B0631019 | 270 | B0631117 | 284 | B3001507 | 26 |
| B0631020 | 270 | B0631118 | 284 | B3001566 | 26 |
| B0631021 | 270 | B0631119 | 285 | B3001567 | 26 |
| B0631023 | 270 | B0631120 | 285 | B3001647 | 64 |
| B0631025 | 270 | B0631121 | 285 | B3001769 | 63 |
| B0631026 | 270 | B0631122 | 285 | B3001770 | 63 |
| B0631027 | 270 | B0631123 | 285 | B3001771 | 63 |
| B0631028 | 270 | B0631124 | 285 | B3001772 | 63 |
| B0631029 | 270 | B0631125 | 285 | B3002006 | 26 |
| B0631030 | 270 | B0631126 | 285 | B3002007 | 26 |
| B0631031 | 270 | B0631127 | 285 | B3002046 | 26 |
| B0631032 | 270 | B0631128 | 273 | B3002102 | 29 |
| B0631033 | 270 | B0631129 | 273 | B3002103 | 29 |
| B0631034 | 270 | B0631130 | 273 | B3120405 | 29 |
| B0631035 | 270 | B0631131 | 273 | B3121301 | 31 |
| B0631036 | 270 | B0631132 | 284 | B3130086 | 31 |
| B0631039 | 271 | B0631134 | 270 | B3140236 | 64 |
| B0631042 | 271 | B0631142 | 285 | B3140361 | 29 |
| B0631045 | 271 | B0631145 | 273 | B3140362 | 29 |
| B0631046 | 271 | B0631149 | 273 | B3140617 | 64 |
| B0631047 | 271 | B0631150 | 273 | B3140618 | 64 |
| B0631048 | 271 | B0631151 | 273 | B3140621 | 64 |
| B0631049 | 271 | B0631152 | 273 | B3140622 | 64 |
| B0631051 | 271 | B0810377 | 45 | B3140715 | 64 |
| B0631057 | 271 | B0851900 | 29 | B3140721 | 62, 64 |
| B0631060 | 271 | B2000159 | 277 | B3140730 | 62, 64 |
| B0631064 | 271 | B2000160 | 277 | B3141064 | 73 |
| B0631065 | 271 | B2000186 | 276 | B3150458 | 24 |
| B0631066 | 271 | B2000310 | 276 | B3150525 | 24, 25 |
| B0631070 | 271 | B2100154 | 283 | B3150531 | 24 |
| B0631071 | 271 | B2190036 | 281 | B4000011 | 228 |
| B0631076 | 271 | B2205021 | 281 | B4000022 | 119 |
| B0631077 | 271 | B2205022 | 281 | B4000025 | 119 |
| B0631079 | 271 | B2500099 | 269 | B4000028 | 119 |
| B0631080 | 271 | B2500100 | 269 | B7001014 | 290 |
| B0631081 | 271 | B2500127 | 273 | C0550303 | 275 |
| B0631082 | 271 | B2500129 | 273 | C6951014 | 280 |
| B0631083 | 271 | B3000055 | 63 | C6951019 | 280 |

| Part No. | Page | Part No. | Page | Part No. | Page |
|----------|----------|----------|----------|----------|----------|
| CP183700 | 276 | L1201944 | 252 | L1271021 | 254 |
| ED020005 | 162 | L1201980 | 252 | L1271102 | 257, 258 |
| ED020015 | 161 | L1202023 | 252 | L1271191 | 257 |
| ED020016 | 161 | L1202024 | 252 | L1271192 | 257 |
| L0171159 | 267 | L1202049 | 252 | L1271193 | 257 |
| L1003006 | 225 | L1202050 | 252 | L1271194 | 257 |
| L1003008 | 225 | L1202057 | 263 | L1271195 | 257 |
| L1003015 | 225 | L1205436 | 252 | L1271202 | 257, 258 |
| L1003027 | 224 | L1240098 | 263 | L1271250 | 257 |
| L1003028 | 224 | L1241446 | 263 | L1271602 | 257, 258 |
| L1003029 | 225 | L1242701 | 267 | L1272002 | 257, 258 |
| L1003030 | 224, 225 | L1250046 | 252 | L1272102 | 257 |
| L1060351 | 261 | L1250048 | 252 | L1272126 | 250 |
| L1180479 | 263 | L1250050 | 250 | L1272127 | 250 |
| L1180480 | 263 | L1250051 | 250 | L1272130 | 253 |
| L1180490 | 263 | L1250052 | 250 | L1272131 | 253 |
| L1181303 | 258 | L1250053 | 250 | L1272133 | 253 |
| L1185153 | 267 | L1250054 | 250 | L1272240 | 255 |
| L1191079 | 262 | L1250220 | 262 | L1272243 | 255 |
| L1191081 | 262 | L1250240 | 252 | L1272247 | 255 |
| L1191082 | 262 | L1250241 | 252 | L1272248 | 255 |
| L1200219 | 263 | L1250242 | 252 | L1272249 | 264 |
| L1200253 | 263 | L1250311 | 263 | L1272265 | 265 |
| L1200311 | 250 | L1250404 | 263 | L1272266 | 265 |
| L1200312 | 250 | L1250425 | 263 | L1272267 | 265 |
| L1200313 | 252 | L1250462 | 263 | L1272268 | 265 |
| L1200314 | 252 | L1250474 | 263 | L1272274 | 253 |
| L1200315 | 252 | L1250475 | 263 | L1272275 | 253 |
| L1200316 | 252 | L1251840 | 263 | L1272276 | 253 |
| L1200321 | 252 | L1270301 | 257 | L1272277 | 253 |
| L1200323 | 252 | L1270402 | 257 | L1272282 | 259, 264 |
| L1200324 | 252 | L1270404 | 257 | L1272283 | 259 |
| L1200325 | 252 | L1270408 | 257 | L1272284 | 259 |
| L1200333 | 252 | L1270409 | 257 | L1272288 | 259 |
| L1200334 | 252 | L1270410 | 257 | L1272289 | 259 |
| L1200335 | 252 | L1270421 | 257 | L1272290 | 259 |
| L1200336 | 252 | L1270512 | 257 | L1272291 | 260 |
| L1200337 | 252 | L1270664 | 257 | L1272292 | 260 |
| L1200338 | 252 | L1270665 | 257 | L1272293 | 260 |
| L1200343 | 252 | L1270666 | 257 | L1272294 | 260 |
| L1200344 | 252 | L1270765 | 257 | L1272298 | 260 |
| L1200345 | 252 | L1270766 | 257, 258 | L1272299 | 259 |
| L1200346 | 252 | L1270941 | 258 | L1272300 | 259 |
| L1200351 | 254 | L1270942 | 258 | L1272301 | 259 |
| L1200406 | 263 | L1270944 | 258 | L1272302 | 259 |
| L1200443 | 263 | L1270947 | 258 | L1272303 | 259 |
| L1200551 | 262 | L1270948 | 258 | L1272307 | 260 |
| L1200552 | 262 | L1270949 | 258 | L1272313 | 253 |
| L1200553 | 262 | L1270951 | 258 | L1272314 | 253 |
| L1200555 | 262 | L1270952 | 258 | L1272315 | 253 |
| L1200556 | 262 | L1270954 | 258 | L1272316 | 253 |
| L1200557 | 262 | L1270957 | 258 | L1272317 | 253 |
| L1200558 | 262 | L1270958 | 258 | L1272318 | 253 |
| L1200559 | 262 | L1270959 | 258 | L1272319 | 253 |
| L1200560 | 262 | L1270961 | 258 | L1272320 | 253 |
| L1200574 | 262 | L1270962 | 258 | L1272321 | 253 |
| L1200587 | 262 | L1270964 | 258 | L1272323 | 253 |
| L1200588 | 262 | L1270967 | 258 | L1272324 | 253 |
| L1200589 | 262 | L1270968 | 258 | L1272325 | 253 |
| L1201654 | 254 | L1270969 | 258 | L1272331 | 253 |
| L1201655 | 254 | L1270970 | 258 | L1272332 | 253 |
| L1201865 | 254 | L1270986 | 257 | L1272333 | 253 |

PART NUMBER INDEX

| Part No. | Page | Part No. | Page | Part No. | Page |
|----------|------|-----------|------|----------|----------|
| L1272334 | 253 | L1272406 | 254 | L1280064 | 252 |
| L1272335 | 253 | L1272407 | 251 | L1280065 | 252 |
| L1272336 | 253 | L1272409 | 254 | L1280066 | 252 |
| L1272337 | 250 | L1272410 | 254 | L1280069 | 250 |
| L1272338 | 253 | L1272412 | 251 | L1280301 | 250 |
| L1272339 | 253 | L1272414 | 251 | L1280302 | 250 |
| L1272340 | 253 | L1272422 | 253 | L1280303 | 250 |
| L1272341 | 253 | L1272423 | 251 | L1280304 | 250 |
| L1272342 | 253 | L1272425 | 253 | L1280305 | 250 |
| L1272344 | 254 | L1272426 | 253 | L1280306 | 254 |
| L1272345 | 254 | L1272427 | 253 | L1280308 | 250 |
| L1272346 | 254 | L1272428 | 253 | L1280312 | 250 |
| L1272347 | 254 | L1272433 | 252 | L1280321 | 250 |
| L1272348 | 254 | L1272440 | 260 | L1280322 | 250 |
| L1272349 | 254 | L1272443 | 251 | L1280323 | 254 |
| L1272350 | 254 | L1272450 | 255 | L1281920 | 267 |
| L1272351 | 254 | L1272451 | 255 | L1281921 | 267 |
| L1272352 | 254 | L1272452 | 255 | L1281922 | 267 |
| L1272354 | 259 | L1272453 | 255 | L1281923 | 267 |
| L1272355 | 259 | L1272454 | 255 | L1281924 | 267 |
| L1272356 | 259 | L1272455 | 255 | L1281925 | 267 |
| L1272357 | 259 | L1272456 | 255 | L1281926 | 267 |
| L1272358 | 259 | L1272457 | 255 | L1281927 | 267 |
| L1272359 | 260 | L1272458 | 254 | L1281928 | 267 |
| L1272361 | 255 | L1272459 | 254 | L1281929 | 267 |
| L1272364 | 260 | L1272461 | 254 | L1281930 | 267 |
| L1272365 | 260 | L1272462 | 254 | L1281931 | 267 |
| L1272366 | 260 | L1272463 | 254 | L1281932 | 267 |
| L1272367 | 260 | L1272463 | 254 | L1281933 | 267 |
| L1272368 | 260 | L1272470 | 259 | L1281934 | 267 |
| L1272369 | 260 | L1272471 | 259 | L1360266 | 252 |
| L1272370 | 259 | L1272472 | 260 | L1360267 | 252 |
| L1272372 | 251 | L1272473 | 260 | L1360268 | 252 |
| L1272373 | 253 | L1272474 | 260 | L1360269 | 252 |
| L1272374 | 253 | L1272475 | 260 | L1360270 | 252 |
| L1272375 | 254 | L1272480 | 260 | L1360271 | 252 |
| L1272376 | 255 | L1272481 | 260 | L1360272 | 252 |
| L1272377 | 255 | L1272482 | 260 | L1360273 | 252 |
| L1272377 | 255 | L1272483 | 250 | L1360275 | 252 |
| L1272380 | 252 | L1272484 | 253 | L1365311 | 265 |
| L1272381 | 251 | L1272485 | 253 | L1365312 | 265 |
| L1272382 | 255 | L1272486 | 253 | L1600107 | 250 |
| L1272383 | 255 | L1272487 | 253 | L1600109 | 250 |
| L1272384 | 250 | L1272487 | 253 | L1600111 | 254 |
| L1272386 | 251 | L1272490 | 262 | L1600113 | 250 |
| L1272387 | 251 | L1272490R | 262 | L1600114 | 250 |
| L1272388 | 251 | L1272491 | 261 | L1600115 | 250 |
| L1272389 | 251 | L1272492 | 261 | L1600116 | 250 |
| L1272390 | 251 | L1272493 | 261 | L1600119 | 255 |
| L1272391 | 251 | L1272494 | 261 | L1600130 | 258 |
| L1272392 | 251 | L1272495 | 262 | L1600233 | 262 |
| L1272393 | 251 | L1272496 | 262 | L1600238 | 262 |
| L1272394 | 251 | L1272498 | 262 | L1600241 | 262 |
| L1272395 | 251 | L1272503 | 250 | L1600242 | 262 |
| L1272396 | 251 | L1272504 | 250 | L1600243 | 262 |
| L1272397 | 251 | L1272505 | 250 | L1600243 | 263 |
| L1272398 | 251 | L1272506 | 250 | L1600244 | 262, 263 |
| L1272399 | 251 | L1272511 | 250 | L1600246 | 262 |
| L1272400 | 251 | L1272512 | 250 | L1600350 | 262 |
| L1272401 | 251 | L1272513 | 250 | L1608001 | 265 |
| L1272402 | 251 | L1272514 | 250 | L1608002 | 265 |
| L1272403 | 254 | L1275102 | 254 | L1608003 | 266 |
| L1272405 | 254 | L1275105 | 254 | | |
| | | L1275106 | 254 | | |

| Part No. | Page | Part No. | Page | Part No. | Page |
|----------|----------|----------|----------|----------------|----------|
| L1608004 | 266 | L4275009 | 224, 225 | L8041803 | 293 |
| L1608005 | 266 | L4275072 | 224 | L8041804 | 293 |
| L1608006 | 266 | L4275089 | 224, 225 | L8041808 | 293 |
| L1608007 | 266 | L4275107 | 224 | L8041809 | 293 |
| L1608008 | 266 | L4275108 | 224 | L90004786 | 291 |
| L1608009 | 266 | L4275110 | 224, 225 | L90004787 | 290 |
| L1608010 | 266 | L6020202 | 279 | L90004788 | 290 |
| L1608012 | 266 | L6020203 | 280 | L9004128 | 262 |
| L1608013 | 266 | L6020204 | 280 | L9004196 | 267 |
| L1608015 | 266 | L6020208 | 279 | L9004198 | 262 |
| L1608022 | 265 | L6020209 | 280 | L9004199 | 262 |
| L1610021 | 262 | L6020211 | 280 | L9004200 | 262 |
| L1610022 | 262 | L6020281 | 286 | L9004319 | 250 |
| L1610023 | 262 | L6020290 | 282 | L9004573 | 267 |
| L1610028 | 262 | L6020313 | 280 | L9004574 | 267 |
| L1860268 | 264 | L6020322 | 280 | L9004575 | 267 |
| L1860269 | 264 | L6020323 | 280 | L9004578 | 267 |
| L1860275 | 264 | L6020328 | 282 | L9004741 | 283 |
| L1860298 | 264 | L6020329 | 269 | L9004783 | 293 |
| L1860317 | 264 | L6020358 | 279 | L9004892 | 267 |
| L1860318 | 264 | L6020371 | 280 | M0410094 | 225 |
| L1860319 | 264 | L6020372 | 280 | M0413535 | 224 |
| L1860334 | 264 | L6022018 | 280 | M0413592 | 228 |
| L1860361 | 264 | L6022022 | 280 | M0413593 | 228 |
| L1860409 | 264 | L6022023 | 280 | M0413595 | 225, 227 |
| L1861634 | 264 | L6022024 | 280 | M0413597 | 227 |
| L2250035 | 288 | L6022025 | 280 | M0413598 | 225, 227 |
| L2250042 | 288 | L6022728 | 268 | M0413625 | 225 |
| L2250101 | 289 | L6301054 | 225 | M0413627 | 224 |
| L2250134 | 287 | L6310010 | 278 | M0413628 | 224, 228 |
| L2250135 | 288 | L6310011 | 278 | MZ101903-17 | 123 |
| L2250136 | 287 | L6310012 | 278 | MZ105057-60180 | 123 |
| L2250138 | 288 | L6310013 | 278 | MZ105094 | 123 |
| L2250139 | 285 | L6310014 | 278 | MZ108391-5001 | 122 |
| L2250140 | 287 | L7110260 | 274 | MZ108391-5002 | 122 |
| L2250141 | 287 | L7110261 | 274 | MZ109004 | 123 |
| L2250144 | 289 | L7110262 | 274 | MZ109017 | 123 |
| L2250145 | 287 | L7110264 | 274 | MZ109197 | 123 |
| L2250150 | 287 | L7110265 | 274 | MZ300061 | 122 |
| L2251157 | 155, 286 | L7110266 | 274 | MZ300085 | 122 |
| L2251293 | 286 | L7110267 | 274 | MZ300095 | 122 |
| L2251692 | 288 | L7110268 | 274 | MZ300096 | 122 |
| L2258003 | 287 | L7110269 | 274 | MZ300503 | 123 |
| L2258004 | 287 | L7110271 | 274 | MZ301193 | 123 |
| L4070023 | 224 | L7110272 | 274 | MZ301198 | 122 |
| L4070207 | 225 | L7110273 | 274 | MZ301199 | 122 |
| L4070208 | 225 | L7110274 | 274 | MZ301236 | 123 |
| L4071029 | 225 | L7110275 | 274 | MZ305382 | 123 |
| L4071034 | 225 | L7110289 | 272 | MZ305385 | 123 |
| L4071123 | 225 | L7110290 | 272 | MZ321146 | 88 |
| L4071151 | 224 | L7110290 | 272 | MZ321147 | 88 |
| L4071594 | 225, 227 | L7110291 | 272 | MZ331300 | 122 |
| L4135472 | 216 | L7110291 | 272 | MZ331301 | 122 |
| L4270009 | 224 | L7110292 | 272 | N0171159 | 263 |
| L4270010 | 224 | L7110293 | 272 | N0370392 | 21, 24 |
| L4270128 | 227 | L8040200 | 293 | N0370393 | 24 |
| L4270129 | 227 | L8040201 | 293 | N0370394 | 24 |
| L4271106 | 224 | L8040202 | 293 | N0371505 | 37 |
| L4271187 | 224, 225 | L8041600 | 293 | N0400058 | 21, 25 |
| L4271203 | 224 | L8041601 | 293 | N0400100 | 20, 21 |
| L4271205 | 224 | L8041800 | 293 | N0400101 | 20, 21 |
| L4271290 | 224, 225 | L8041801 | 293 | N0400102 | 20, 21 |
| | | L8041802 | 293 | | |

PART NUMBER INDEX

| Part No. | Page | Part No. | Page | Part No. | Page |
|----------|------------|----------|--------|----------|--------|
| N0400103 | 20, 21 | N0770420 | 41 | N0775014 | 44 |
| N0401171 | 21 | N0770437 | 42 | N0775177 | 41, 44 |
| N0580531 | 91 | N0770438 | 44 | N0775220 | 91 |
| N0581455 | 45 | N0770546 | 37, 41 | N0775223 | 44 |
| N0581497 | 45 | N0770600 | 38, 40 | N0775224 | 44 |
| N0582152 | 78 | N0770603 | 44 | N0775225 | 44 |
| N0582184 | 44 | N0770606 | 40 | N0775226 | 44 |
| N0582185 | 44 | N0770607 | 40 | N0775227 | 44 |
| N0582186 | 44 | N0770609 | 40 | N0775228 | 44 |
| N0582251 | 91 | N0770610 | 37 | N0775247 | 44 |
| N0680275 | 45 | N0770613 | 38 | N0775289 | 41, 42 |
| N0680504 | 34 | N0770614 | 38, 41 | N0775297 | 41, 42 |
| N0680504 | 37, 48, 52 | N0770689 | 41 | N0775300 | 45 |
| N0680612 | 48 | N0770730 | 41 | N0775325 | 91 |
| N0681470 | 78 | N0770731 | 41 | N0775330 | 34 |
| N0681574 | 34, 48 | N0770732 | 41 | N0775331 | 37 |
| N0681631 | 54 | N0770910 | 40 | N0775340 | 35, 49 |
| N0681690 | 42 | N0770911 | 40 | N0775341 | 49 |
| N0690269 | 44 | N0770916 | 42 | N0775342 | 49, 58 |
| N0690271 | 38 | N0770944 | 45 | N0775343 | 49 |
| N0690568 | 42 | N0770965 | 41 | N0775344 | 49 |
| N0690610 | 40 | N0770965 | 41 | N0775344 | 49 |
| N0690640 | 39 | N0771116 | 45 | N0775345 | 35 |
| N0690666 | 45 | N0771500 | 41, 42 | N0775346 | 34 |
| N0690668 | 45 | N0771501 | 39, 41 | N0775347 | 34 |
| N0690670 | 37 | N0771526 | 44 | N0775348 | 34 |
| N0690672 | 45 | N0771527 | 44 | N0775349 | 34 |
| N0690676 | 37 | N0771529 | 63 | N0775350 | 52 |
| N0690712 | 40 | N0771531 | 41, 44 | N0775351 | 38 |
| N0690720 | 39 | N0771536 | 45 | N0775352 | 39, 58 |
| N0690769 | 44 | N0771561 | 42 | N0775355 | 39 |
| N0690772 | 45 | N0771725 | 47 | N0775356 | 39 |
| N0690812 | 40 | N0771726 | 47 | N0775358 | 35, 49 |
| N0691579 | 72 | N0772005 | 41, 42 | N0776006 | 38 |
| N0691580 | 78 | N0772006 | 41 | N0776007 | 38 |
| N0691581 | 70, 78 | N0772008 | 42 | N0776014 | 41 |
| N0691595 | 60 | N0772017 | 38 | N0776025 | 41 |
| N0691662 | 42 | N0773084 | 45 | N0776052 | 38, 41 |
| N0691664 | 42 | N0773090 | 45 | N0776053 | 39 |
| N0691678 | 45 | N0773106 | 47 | N0776090 | 39, 41 |
| N0691689 | 45 | N0773111 | 60 | N0776091 | 41, 44 |
| N0691745 | 70 | N0773112 | 60, 61 | N0776093 | 41, 44 |
| N0691907 | 87 | N0773113 | 58, 60 | N0776099 | 87 |
| N0695295 | 42 | N0773114 | 39 | N0776103 | 84 |
| N0695362 | 44 | N0773115 | 60 | N0776104 | 83 |
| N0695379 | 42 | N0773116 | 60 | N0776105 | 83 |
| N0695442 | 44 | N0773117 | 60 | N0776106 | 83 |
| N0695449 | 44 | N0773118 | 60 | N0776107 | 83 |
| N0695456 | 42 | N0773119 | 60 | N0776108 | 83 |
| N0695460 | 44 | N0773120 | 81 | N0776109 | 83 |
| N0695461 | 44 | N0773196 | 51 | N0776116 | 65 |
| N0695476 | 60 | N0773197 | 36 | N0776118 | 65 |
| N0695477 | 55 | N0774067 | 61 | N0777031 | 34 |
| N0695494 | 44 | N0774068 | 61 | N0777032 | 34 |
| N0695495 | 44, 54 | N0774069 | 49 | N0777033 | 34 |
| N0770322 | 45 | N0774070 | 41, 43 | N0777034 | 51 |
| N0770336 | 37 | N0774077 | 36, 49 | N0777035 | 51 |
| N0770338 | 41, 42 | N0774080 | 36, 49 | N0777042 | 59, 60 |
| N0770343 | 42 | N0774085 | 64 | N0777043 | 60 |
| N0770344 | 42 | N0774088 | 63 | N0777044 | 44 |
| N0770357 | 39, 41 | N0774095 | 65 | N0777049 | 36 |
| N0770358 | 37, 41 | N0774096 | 65 | N0777051 | 43 |
| | | N0774101 | 38 | N0777052 | 43 |

| Part No. | Page | Part No. | Page | Part No. | Page |
|----------|---------|----------|------------|----------|--------|
| N0777053 | 43 | N0777285 | 63 | N0777606 | 46 |
| N0777054 | 43 | N0777286 | 63 | N0777607 | 46 |
| N0777055 | 43, 55 | N0777298 | 64 | N0777608 | 46 |
| N0777061 | 36, 49 | N0777328 | 91 | N0777609 | 46 |
| N0777062 | 64 | N0777359 | 91 | N0777610 | 46 |
| N0777063 | 84 | N0777360 | 91 | N0777611 | 46 |
| N0777064 | 84 | N0777364 | 53 | N0777612 | 46 |
| N0777071 | 65 | N0777413 | 36 | N0777613 | 89 |
| N0777072 | 65 | N0777414 | 34 | N0777676 | 36 |
| N0777095 | 87, 91 | N0777415 | 55 | N0777681 | 89 |
| N0777110 | 60 | N0777416 | 55 | N0777682 | 89 |
| N0777111 | 34 | N0777417 | 55 | N0777689 | 89 |
| N0777112 | 34 | N0777419 | 55 | N0777690 | 89 |
| N0777113 | 34 | N0777420 | 55 | N0777691 | 65 |
| N0777114 | 34 | N0777435 | 36, 49 | N0777692 | 65 |
| N0777115 | 34 | N0777436 | 36, 49, 61 | N0777693 | 65 |
| N0777116 | 34 | N0777437 | 36, 49 | N0777694 | 65 |
| N0777117 | 34 | N0777438 | 38, 52 | N0777695 | 65 |
| N0777148 | 64 | N0777439 | 38, 52 | N0777696 | 65 |
| N0777149 | 64 | N0777441 | 60 | N0777697 | 65 |
| N0777150 | 64 | N0777442 | 60 | N0777698 | 65 |
| N0777151 | 64 | N0777443 | 60 | N0777699 | 65 |
| N0777152 | 64 | N0777444 | 59, 60 | N0777700 | 65 |
| N0777153 | 64 | N0777445 | 60 | N0777701 | 65 |
| N0777154 | 64 | N0777446 | 60 | N0777702 | 65 |
| N0777155 | 64 | N0777447 | 60 | N0777703 | 65 |
| N0777156 | 65 | N0777460 | 34, 36, 48 | N0777704 | 65 |
| N0777159 | 65 | N0777462 | 36, 49 | N0777705 | 65 |
| N0777167 | 65, 262 | N0777463 | 36, 49, 61 | N0777706 | 65 |
| N0777168 | 65 | N0777464 | 36, 49, 61 | N0777707 | 34 |
| N0777169 | 64 | N0777465 | 61 | N0777707 | 41 |
| N0777219 | 36 | N0777466 | 61 | N0777710 | 91 |
| N0777220 | 50 | N0777476 | 60 | N0777711 | 60 |
| N0777221 | 63 | N0777484 | 49 | N0777712 | 35, 49 |
| N0777222 | 63 | N0777485 | 49 | N0777713 | 35 |
| N0777223 | 63 | N0777486 | 49 | N0777714 | 35 |
| N0777224 | 63 | N0777487 | 35 | N0777715 | 43 |
| N0777225 | 63 | N0777488 | 35 | N0777719 | 89 |
| N0777226 | 63 | N0777489 | 35 | N0777731 | 39, 41 |
| N0777227 | 63 | N0777490 | 35 | N0777734 | 35 |
| N0777228 | 64 | N0777494 | 38 | N0777735 | 35 |
| N0777229 | 64 | N0777495 | 39 | N0777736 | 35 |
| N0777230 | 64 | N0777496 | 39 | N0777737 | 35 |
| N0777231 | 64 | N0777497 | 39 | N0777738 | 35 |
| N0777232 | 64 | N0777508 | 43 | N0777783 | 47 |
| N0777233 | 64 | N0777509 | 43 | N0777784 | 47 |
| N0777234 | 64 | N0777510 | 43 | N0777785 | 47 |
| N0777235 | 64 | N0777511 | 89, 123 | N0777840 | 43 |
| N0777242 | 64 | N0777512 | 36, 49 | N0777841 | 43 |
| N0777243 | 64 | N0777513 | 36, 49 | N0777842 | 43 |
| N0777244 | 64 | N0777514 | 36, 49 | N0777843 | 43 |
| N0777245 | 64 | N0777518 | 60 | N0777844 | 38, 39 |
| N0777246 | 64 | N0777521 | 60 | N0777845 | 36, 49 |
| N0777247 | 64 | N0777547 | 63 | N0777846 | 36, 49 |
| N0777248 | 64 | N0777561 | 60 | N0777847 | 36, 49 |
| N0777249 | 64 | N0777565 | 63 | N0777848 | 61 |
| N0777250 | 64 | N0777568 | 63 | N0777870 | 27 |
| N0777251 | 64 | N0777599 | 65, 262 | N0777871 | 27 |
| N0777252 | 64 | N0777602 | 46 | N0777874 | 60 |
| N0777253 | 64 | N0777603 | 46 | N0777880 | 43 |
| N0777266 | 63 | N0777604 | 46 | N0777881 | 46 |
| N0777267 | 63 | N0777605 | 46 | N0777882 | 46 |

PART NUMBER INDEX

| Part No. | Page | Part No. | Page | Part No. | Page |
|----------|--------------------|----------|------|----------|------|
| N0777883 | 46 | N2010245 | 25 | N2025357 | 19 |
| N0777900 | 47, 96 | N2010246 | 25 | N2025358 | 19 |
| N0777901 | 65 | N2010247 | 25 | N2025359 | 19 |
| N0777920 | 88 | N2010250 | 25 | N2025360 | 19 |
| N0777930 | 47 | N2011074 | 21 | N2025361 | 19 |
| N0777940 | 65 | N2025300 | 19 | N2025362 | 19 |
| N0777941 | 65 | N2025301 | 19 | N2025363 | 19 |
| N0777942 | 65 | N2025302 | 19 | N2025364 | 19 |
| N0780128 | 43 | N2025303 | 19 | N2025365 | 19 |
| N0780130 | 41, 42 | N2025304 | 19 | N2025366 | 19 |
| N0780132 | 41, 42 | N2025305 | 19 | N2061174 | 158 |
| N0780133 | 42 | N2025306 | 19 | N2350162 | 154 |
| N0780437 | 42 | N2025307 | 19 | N2350211 | 154 |
| N0780546 | 37, 41 | N2025308 | 19 | N2351285 | 155 |
| N0780606 | 40 | N2025309 | 19 | N2410092 | 298 |
| N0780607 | 40 | N2025310 | 19 | N2410145 | 298 |
| N0780608 | 41 | N2025311 | 19 | N2410152 | 298 |
| N0780616 | 41 | N2025312 | 19 | N2410153 | 299 |
| N0780617 | 41 | N2025313 | 19 | N2410154 | 299 |
| N0780676 | 37 | N2025314 | 19 | N2410155 | 299 |
| N0781007 | 41, 44 | N2025315 | 19 | N2410157 | 298 |
| N0781008 | 44 | N2025316 | 19 | N2410164 | 298 |
| N0781009 | 44 | N2025317 | 19 | N2410165 | 298 |
| N0781013 | 44 | N2025318 | 19 | N2410166 | 298 |
| N0781014 | 41, 44 | N2025319 | 19 | N2410168 | 298 |
| N0781015 | 44 | N2025320 | 19 | N2410177 | 298 |
| N0781016 | 44 | N2025321 | 19 | N2410188 | 298 |
| N0781017 | 44 | N2025322 | 19 | N2410191 | 298 |
| N0781018 | 44 | N2025323 | 19 | N2410212 | 299 |
| N0781019 | 44 | N2025324 | 19 | N2410244 | 299 |
| N0781050 | 44 | N2025325 | 19 | N2410277 | 298 |
| N0781097 | 41, 42 | N2025326 | 19 | N2410278 | 298 |
| N0782004 | 44 | N2025327 | 19 | N2410320 | 299 |
| N0782005 | 44 | N2025328 | 19 | N2410324 | 298 |
| N0782006 | 44 | N2025329 | 19 | N2410325 | 298 |
| N0782007 | 44 | N2025330 | 19 | N2410330 | 299 |
| N0782008 | 44 | N2025331 | 19 | N2410331 | 298 |
| N0782009 | 44 | N2025332 | 19 | N2410332 | 298 |
| N0782010 | 44 | N2025333 | 19 | N2410501 | 298 |
| N1010070 | 119 | N2025334 | 19 | N2410506 | 298 |
| N1010504 | 269 | N2025335 | 19 | N2410507 | 298 |
| N1010520 | 281 | N2025336 | 19 | N2410513 | 298 |
| N1010539 | 269 | N2025337 | 19 | N2410518 | 298 |
| N1010565 | 277 | N2025338 | 19 | N2410683 | 298 |
| N1010566 | 277 | N2025339 | 19 | N2410684 | 298 |
| N1010567 | 276 | N2025340 | 19 | N2410693 | 298 |
| N1010568 | 276 | N2025341 | 19 | N2410694 | 298 |
| N1010569 | 276 | N2025342 | 19 | N2410695 | 298 |
| N1011210 | 120, 228 | N2025343 | 19 | N2410696 | 298 |
| N1011445 | 204, 210 | N2025344 | 19 | N2410697 | 298 |
| N1011446 | 204, 209, 210, 211 | N2025345 | 19 | N2410698 | 298 |
| N1011447 | 209, 211 | N2025346 | 19 | N2411235 | 299 |
| N1015158 | 278 | N2025347 | 19 | N2411255 | 299 |
| N1016070 | 282 | N2025348 | 19 | N2411264 | 299 |
| N1016071 | 282 | N2025349 | 19 | N2411273 | 298 |
| N1016072 | 282 | N2025350 | 19 | N2411291 | 299 |
| N1016073 | 282 | N2025351 | 19 | N2411300 | 299 |
| N1016074 | 282 | N2025352 | 19 | N2411333 | 298 |
| N1870151 | 264 | N2025353 | 19 | N2411335 | 298 |
| N1870184 | 264 | N2025354 | 19 | N2411359 | 299 |
| N1870185 | 264 | N2025355 | 19 | N2411362 | 299 |
| N1870188 | 264 | N2025356 | 19 | N2411363 | 299 |

| Part No. | Page | Part No. | Page | Part No. | Page |
|----------|---------------|----------|----------|----------|----------|
| N2411364 | 299 | N2910511 | 158 | N2920126 | 154 |
| N2411401 | 298 | N2910512 | 158 | N2920128 | 154 |
| N2411514 | 299 | N2910515 | 158 | N2920146 | 155 |
| N2411527 | 298 | N2910765 | 165 | N2920149 | 155 |
| N2421070 | 299 | N2911127 | 165 | N2920160 | 154 |
| N2580003 | 150 | N2911170 | 165 | N2920191 | 126 |
| N2580012 | 150 | N2911196 | 123 | N2920193 | 126 |
| N2580013 | 150 | N2911197 | 123 | N2922011 | 155 |
| N2580020 | 150 | N2911198 | 123 | N2922030 | 154 |
| N2580021 | 150 | N2911199 | 123 | N2922046 | 155 |
| N2580022 | 150 | N2911200 | 165 | N2922082 | 155 |
| N2580030 | 153 | N2911201 | 165 | N2922107 | 154 |
| N2580042 | 150 | N2911202 | 165 | N2922211 | 154 |
| N2600070 | 160 | N2911203 | 165 | N2925030 | 155 |
| N2600089 | 160 | N2911205 | 165 | N2925090 | 154 |
| N2600104 | 158 | N2911206 | 165 | N2925091 | 154 |
| N2600124 | 158 | N2911210 | 165 | N2930035 | 167 |
| N2600192 | 158 | N2911211 | 165 | N2930036 | 167 |
| N2600226 | 158 | N2911212 | 165 | N2930037 | 167 |
| N2600259 | 160 | N2911220 | 159 | N2930038 | 167 |
| N2600284 | 157 | N2911221 | 159, 165 | N2930040 | 167 |
| N2600313 | 160 | N2911224 | 159, 165 | N2930041 | 167 |
| N2600457 | 157 | N2911235 | 159 | N2930042 | 167 |
| N2600458 | 157 | N2911236 | 159 | N2930043 | 167 |
| N2600459 | 157 | N2911239 | 159 | N2930044 | 167 |
| N2600491 | 157 | N2911240 | 159 | N2930146 | 167 |
| N2600495 | 157 | N2911241 | 159 | N2930147 | 167 |
| N2600496 | 157 | N2911244 | 159 | N2930313 | 165, 168 |
| N2600497 | 156, 157 | N2911245 | 159 | N2930314 | 167 |
| N2600498 | 156, 157 | N2911249 | 159 | N2930660 | 164 |
| N2600499 | 157 | N2911250 | 159 | N2930661 | 164 |
| N2600506 | 157 | N2911251 | 159 | N2930664 | 164 |
| N2600522 | 156 | N2915006 | 158 | N2930669 | 164 |
| N2600523 | 156 | N2916016 | 160 | N2930672 | 164 |
| N2600570 | 156 | N2916019 | 160 | N2930673 | 164 |
| N2600571 | 156 | N2916052 | 158 | N2930675 | 164 |
| N2601189 | 157, 162, 168 | N2916056 | 165 | N2930676 | 164 |
| N2601262 | 160 | N2916059 | 161 | N2930801 | 168 |
| N2601295 | 160 | N2916085 | 160 | N2930802 | 168 |
| N2601313 | 160 | N2916200 | 161, 165 | N2931054 | 166 |
| N2601316 | 160 | N2916201 | 165 | N2931097 | 167 |
| N2601477 | 160 | N2916202 | 162 | N2931199 | 165, 212 |
| N2601503 | 160 | N2916210 | 161, 165 | N2931275 | 160 |
| N2601610 | 156 | N2916211 | 161 | N2932000 | 164 |
| N2601611 | 156 | N2916212 | 165 | N2932001 | 164 |
| N2601612 | 156 | N2916213 | 165 | N2932002 | 164 |
| N2601613 | 156 | N2916214 | 165 | N2936000 | 165, 212 |
| N2601614 | 156 | N2916215 | 165 | N2936003 | 164 |
| N2601615 | 156 | N2916216 | 165 | N2936009 | 165, 212 |
| N2601616 | 156, 165 | N2916217 | 165 | N2936010 | 165, 212 |
| N2601617 | 156 | N2916218 | 165 | N2936020 | 164 |
| N2910035 | 154, 160 | N2916219 | 165 | N2936021 | 164 |
| N2910036 | 154 | N2916222 | 165 | N2936022 | 164 |
| N2910342 | 160 | N2916223 | 165 | N2936042 | 164 |
| N2910343 | 160 | N2916224 | 165 | N2936043 | 164 |
| N2910344 | 160 | N2916260 | 165 | N2936045 | 164 |
| N2910345 | 154, 160 | N2916261 | 168 | N2936046 | 164 |
| N2910346 | 160 | N2916262 | 165, 168 | N2936048 | 164 |
| N2910349 | 160 | N2918536 | 159 | N2936049 | 164 |
| N2910383 | 154, 160 | N2920070 | 154 | N2936050 | 164 |
| N2910384 | 154, 160 | N2920117 | 154 | N2936051 | 165, 212 |
| N2910385 | 160 | N2920124 | 154 | N2936052 | 165, 212 |

PART NUMBER INDEX

| Part No. | Page | Part No. | Page | Part No. | Page |
|----------|----------|----------|------|----------|------|
| N2936053 | 165, 212 | N3050157 | 14 | N3050337 | 14 |
| N2936054 | 165, 212 | N3050158 | 14 | N3050338 | 14 |
| N2936055 | 165, 212 | N3050161 | 14 | N3050339 | 14 |
| N2936056 | 161 | N3050162 | 14 | N3050341 | 14 |
| N2936057 | 161 | N3050165 | 14 | N3050342 | 14 |
| N2936058 | 161 | N3050166 | 14 | N3050344 | 14 |
| N2936059 | 161 | N3050168 | 15 | N3050345 | 14 |
| N2936060 | 161 | N3050170 | 14 | N3050346 | 14 |
| N2936061 | 161 | N3050171 | 15 | N3050348 | 15 |
| N2936062 | 161 | N3050172 | 15 | N3050349 | 14 |
| N2936063 | 161 | N3050173 | 15 | N3050350 | 14 |
| N2936064 | 161 | N3050174 | 15 | N3050352 | 14 |
| N2936065 | 161 | N3050175 | 15 | N3050355 | 14 |
| N2936071 | 161 | N3050176 | 15 | N3050357 | 14 |
| N2936072 | 161 | N3050177 | 15 | N3050358 | 14 |
| N2936073 | 161 | N3050178 | 15 | N3050361 | 14 |
| N2936074 | 161 | N3050180 | 15 | N3050362 | 14 |
| N2936075 | 161 | N3050182 | 15 | N3050365 | 14 |
| N2936076 | 161 | N3050183 | 15 | N3050366 | 14 |
| N2936077 | 161 | N3050184 | 15 | N3050368 | 15 |
| N2936078 | 161 | N3050186 | 15 | N3050370 | 14 |
| N2936079 | 161 | N3050187 | 15 | N3050371 | 15 |
| N2936080 | 161 | N3050189 | 15 | N3050372 | 15 |
| N2936081 | 161 | N3050190 | 15 | N3050373 | 15 |
| N2936082 | 161 | N3050191 | 15 | N3050374 | 15 |
| N2936342 | 165, 212 | N3050192 | 15 | N3050375 | 15 |
| N3050102 | 15 | N3050201 | 15 | N3050376 | 15 |
| N3050103 | 14 | N3050202 | 15 | N3050377 | 15 |
| N3050105 | 14 | N3050203 | 15 | N3050378 | 15 |
| N3050107 | 14 | N3050204 | 15 | N3050380 | 15 |
| N3050108 | 14 | N3050205 | 15 | N3050382 | 15 |
| N3050109 | 14 | N3050206 | 15 | N3050383 | 15 |
| N3050110 | 14 | N3050208 | 15 | N3050384 | 15 |
| N3050111 | 14 | N3050209 | 15 | N3050386 | 15 |
| N3050114 | 14 | N3050212 | 15 | N3050387 | 15 |
| N3050115 | 14 | N3050213 | 15 | N3050389 | 15 |
| N3050118 | 14 | N3050214 | 15 | N3050390 | 15 |
| N3050119 | 14 | N3050217 | 15 | N3050391 | 15 |
| N3050121 | 14 | N3050218 | 15 | N3050392 | 15 |
| N3050122 | 14 | N3050302 | 15 | N3050401 | 15 |
| N3050123 | 14 | N3050303 | 14 | N3050402 | 15 |
| N3050124 | 14 | N3050305 | 14 | N3050403 | 15 |
| N3050126 | 14 | N3050307 | 14 | N3050404 | 15 |
| N3050128 | 14 | N3050308 | 14 | N3050405 | 15 |
| N3050129 | 14 | N3050309 | 14 | N3050406 | 15 |
| N3050130 | 14 | N3050310 | 14 | N3050408 | 15 |
| N3050133 | 14 | N3050311 | 14 | N3050409 | 15 |
| N3050134 | 14 | N3050314 | 14 | N3050412 | 15 |
| N3050135 | 14 | N3050315 | 14 | N3050413 | 15 |
| N3050137 | 14 | N3050318 | 14 | N3050414 | 15 |
| N3050138 | 14 | N3050319 | 14 | N3050417 | 15 |
| N3050139 | 14 | N3050321 | 14 | N3050418 | 15 |
| N3050141 | 14 | N3050322 | 14 | N3050605 | 16 |
| N3050142 | 14 | N3050323 | 14 | N3050611 | 16 |
| N3050144 | 14 | N3050324 | 14 | N3050615 | 16 |
| N3050145 | 14 | N3050326 | 14 | N3050620 | 16 |
| N3050146 | 14 | N3050328 | 14 | N3050630 | 16 |
| N3050148 | 15 | N3050329 | 14 | N3050634 | 16 |
| N3050149 | 14 | N3050330 | 14 | N3050655 | 16 |
| N3050150 | 14 | N3050333 | 14 | N3050657 | 16 |
| N3050152 | 14 | N3050334 | 14 | N3050664 | 16 |
| N3050155 | 14 | N3050335 | 14 | N3050670 | 16 |

| Part No. | Page | Part No. | Page | Part No. | Page |
|----------|------|----------|------------|----------|------|
| N3050672 | 16 | N3133019 | 97 | N5190330 | 294 |
| N3050675 | 16 | N3133021 | 97 | N5190376 | 293 |
| N3050680 | 16 | N3133022 | 97 | N5190377 | 293 |
| N3050683 | 16 | N3133023 | 97 | N5190378 | 293 |
| N3050691 | 16 | N3133024 | 96 | N5190393 | 293 |
| N3050860 | 16 | N3134000 | 97 | N5190399 | 293 |
| N3050861 | 16 | N3134002 | 97 | N5190416 | 293 |
| N3050862 | 16 | N3134004 | 97 | N5190417 | 293 |
| N3050863 | 16 | N3134005 | 97 | N5190515 | 294 |
| N3050864 | 16 | N3134007 | 97 | N5190516 | 294 |
| N3050865 | 16 | N3134009 | 97 | N5190609 | 293 |
| N3050866 | 16 | N3134010 | 97 | N5190611 | 293 |
| N3050867 | 16 | N3134011 | 97 | N5190615 | 293 |
| N3050868 | 16 | N3134012 | 97 | N5190616 | 295 |
| N3050869 | 16 | N3134013 | 97 | N5190619 | 293 |
| N3050870 | 16 | N3134014 | 97 | N5190762 | 292 |
| N3050871 | 16 | N3134015 | 96 | N5190788 | 290 |
| N3050872 | 16 | N3134064 | 96 | N5190869 | 295 |
| N3050873 | 16 | N3134072 | 97 | N5191549 | 293 |
| N3050874 | 16 | N3150131 | 17 | N5191662 | 293 |
| N3110145 | 31 | N3150188 | 24 | N5191700 | 293 |
| N3110146 | 30 | N3150230 | 21 | N5191875 | 294 |
| N3110147 | 28 | N3150232 | 21, 25 | N5200040 | 295 |
| N3130100 | 95 | N3150303 | 17 | N5200042 | 295 |
| N3130110 | 95 | N3160143 | 24, 25 | N5200045 | 295 |
| N3131005 | 96 | N3160144 | 24, 25 | N5201021 | 295 |
| N3131006 | 96 | N3160146 | 25 | N5201022 | 295 |
| N3131007 | 96 | N3160152 | 25 | N5201023 | 295 |
| N3131008 | 96 | N3160153 | 25 | N5201024 | 295 |
| N3131009 | 96 | N3160154 | 25 | N5202083 | 294 |
| N3131010 | 96 | N3160156 | 25 | N5203115 | 290 |
| N3131011 | 96 | N3160157 | 25 | N5316000 | 86 |
| N3132000 | 96 | N3160158 | 25 | N5316001 | 86 |
| N3132001 | 97 | N3160159 | 25 | N5316002 | 86 |
| N3132002 | 97 | N3160179 | 24 | N5316003 | 86 |
| N3132003 | 97 | N3160182 | 24 | N5316004 | 86 |
| N3132004 | 97 | N3160188 | 25 | N5316005 | 86 |
| N3132005 | 97 | N3160189 | 25 | N5316024 | 86 |
| N3132006 | 97 | N3160192 | 25 | N5316025 | 86 |
| N3132007 | 97 | N3160193 | 25 | N5330177 | 297 |
| N3132008 | 97 | N3160194 | 25 | N5330178 | 297 |
| N3132009 | 96 | N3160505 | 21, 24, 25 | N5330220 | 296 |
| N3132010 | 96 | N3160506 | 21 | N5330253 | 296 |
| N3132011 | 96 | N3160511 | 21, 24, 25 | N5330254 | 297 |
| N3132012 | 96 | N3160546 | 21 | N5330262 | 297 |
| N3132013 | 96 | N3160809 | 21 | N5330300 | 296 |
| N3132014 | 97 | N3161040 | 21 | N5330301 | 296 |
| N3132015 | 97 | N3161240 | 21 | N5330302 | 296 |
| N3133003 | 97 | N5190172 | 294 | N5330303 | 296 |
| N3133006 | 97 | N5190180 | 291 | N5330304 | 296 |
| N3133007 | 97 | N5190196 | 294 | N5330305 | 296 |
| N3133008 | 97 | N5190197 | 294 | N5330306 | 296 |
| N3133009 | 97 | N5190202 | 294 | N5330307 | 296 |
| N3133010 | 97 | N5190203 | 294 | N5330308 | 296 |
| N3133011 | 97 | N5190264 | 294 | N5330309 | 296 |
| N3133012 | 96 | N5190276 | 294 | N5330310 | 296 |
| N3133013 | 96 | N5190279 | 294 | N5330311 | 296 |
| N3133014 | 96 | N5190280 | 295 | N5330312 | 296 |
| N3133015 | 96 | N5190282 | 294 | N5330313 | 296 |
| N3133016 | 96 | N5190283 | 295 | N5330314 | 296 |
| N3133017 | 97 | N5190284 | 294 | N5330315 | 296 |
| N3133018 | 97 | N5190285 | 294 | N5330316 | 296 |

PART NUMBER INDEX

| Part No. | Page | Part No. | Page | Part No. | Page |
|----------|------|----------|--------------------|----------|---------------|
| N5330317 | 296 | N6000637 | 216 | N6101760 | 212 |
| N5330318 | 296 | N6000981 | 216 | N6102354 | 214, 215, 225 |
| N5330319 | 296 | N6000986 | 217 | N6103089 | 214 |
| N5330320 | 296 | N6001204 | 214 | N6103151 | 214 |
| N5330322 | 297 | N6003057 | 216 | N6103167 | 214 |
| N5330323 | 297 | N6003066 | 216 | N6103175 | 214 |
| N5330324 | 297 | N6100016 | 215 | N6103188 | 214 |
| N5330338 | 296 | N6100038 | 218 | N6103225 | 214 |
| N5330340 | 296 | N6100047 | 204 | N6103240 | 212 |
| N5330341 | 296 | N6100048 | 206 | N6103241 | 212 |
| N5330342 | 296 | N6100102 | 204, 207, 215 | N6103242 | 212 |
| N5330343 | 296 | N6100153 | 204, 206, 208, 209 | N6103243 | 212 |
| N5330344 | 296 | N6100157 | 204 | N6107032 | 198 |
| N5330400 | 297 | N6100158 | 204 | N6107033 | 198 |
| N5330402 | 296 | N6100159 | 204, 209 | N6107040 | 198 |
| N5330403 | 296 | N6100161 | 217 | N6107041 | 198 |
| N5330404 | 296 | N6100194 | 214, 215 | N6107048 | 198 |
| N5330405 | 296 | N6100228 | 218 | N6107052 | 198 |
| N5330604 | 297 | N6100243 | 216 | N6107053 | 198 |
| N5330613 | 297 | N6100244 | 216 | N6107056 | 198 |
| N5331098 | 296 | N6100245 | 216 | N6107057 | 198 |
| N5337024 | 297 | N6100253 | 218 | N6107060 | 198 |
| N5337031 | 296 | N6100256 | 208 | N6107061 | 198 |
| N5340090 | 297 | N6100260 | 209 | N6107070 | 198 |
| N5340188 | 291 | N6100261 | 209 | N6107072 | 198 |
| N5340229 | 293 | N6100264 | 216 | N6107073 | 198 |
| N5356002 | 291 | N6100275 | 204, 209 | N6107075 | 198 |
| N5356003 | 291 | N6100289 | 215 | N6107076 | 198 |
| N5356008 | 290 | N6100331 | 204 | N6107198 | 199 |
| N5356010 | 290 | N6100357 | 214 | N6107199 | 199 |
| N5356012 | 290 | N6100361 | 214 | N6107200 | 199 |
| N5356016 | 291 | N6100364 | 214 | N6107201 | 199 |
| N5356017 | 291 | N6100430 | 214 | N6107208 | 198 |
| N5356019 | 291 | N6100447 | 207 | N6107216 | 198 |
| N5356020 | 291 | N6101034 | 204, 209 | N6107218 | 198 |
| N5356021 | 291 | N6101048 | 206 | N6107221 | 198 |
| N5356034 | 291 | N6101050 | 206 | N6107222 | 198 |
| N5361078 | 292 | N6101052 | 204, 210 | N6107224 | 198 |
| N5361180 | 292 | N6101085 | 214 | N6107225 | 198 |
| N5365048 | 296 | N6101182 | 207 | N6107226 | 198 |
| N5365049 | 296 | N6101251 | 212 | N6107227 | 198 |
| N5370140 | 295 | N6101252 | 212 | N6107228 | 198 |
| N5370330 | 294 | N6101253 | 212 | N6107229 | 198 |
| N5370438 | 295 | N6101297 | 214 | N6107230 | 198 |
| N5370459 | 294 | N6101345 | 215 | N6107232 | 198 |
| N5370464 | 295 | N6101358 | 204 | N6120001 | 200, 207 |
| N5370478 | 294 | N6101372 | 204, 210 | N6120006 | 214, 220 |
| N5370487 | 294 | N6101374 | 204 | N6120007 | 206 |
| N5370488 | 294 | N6101375 | 211 | N6120008 | 206 |
| N5370490 | 294 | N6101378 | 204 | N6120009 | 205 |
| N5370492 | 295 | N6101380 | 212 | N6120011 | 217 |
| N5370495 | 295 | N6101390 | 117, 207, 212 | N6120012 | 220 |
| N5370550 | 295 | N6101412 | 215 | N6120014 | 217 |
| N5370553 | 295 | N6101474 | 224 | N6120015 | 220 |
| N5370554 | 295 | N6101482 | 204, 209 | N6120020 | 214, 220 |
| N5370555 | 295 | N6101539 | 209, 211 | N6120022 | 205 |
| N5373009 | 297 | N6101696 | 219 | N6120025 | 206 |
| N5374092 | 296 | N6101702 | 208 | N6120026 | 217 |
| N5376097 | 292 | N6101703 | 208, 211 | N6120027 | 220 |
| N5391051 | 293 | N6101705 | 209 | N6120047 | 219 |
| N5391054 | 293 | N6101747 | 207, 209 | N6120050 | 205 |
| N5391181 | 293 | N6101751 | 209 | N6120057 | 219 |

| Part No. | Page | Part No. | Page | Part No. | Page |
|----------|---------------|----------|---------------|----------|------------------------------|
| N6120059 | 214, 217, 219 | N6200150 | 224, 228 | N6520010 | 206 |
| N6120061 | 219 | N6301054 | 224 | N6520011 | 206 |
| N6120062 | 219 | N6352030 | 120 | N6520012 | 205 |
| N6120070 | 215 | N6352031 | 120 | N6520013 | 205 |
| N6120071 | 206 | N6352032 | 120 | N6520014 | 209 |
| N6120072 | 206 | N6352033 | 120 | N6520015 | 209 |
| N6120074 | 209 | N6356471 | 118 | N6520018 | 214 |
| N6120075 | 209 | N6356472 | 118 | N6520019 | 214 |
| N6120076 | 208 | N6356473 | 116 | N6520020 | 217 |
| N6120077 | 208 | N6356474 | 119 | N6520021 | 217 |
| N6120080 | 220 | N6356475 | 119 | N6520022 | 220 |
| N6120082 | 208 | N6356477 | 119 | N6520023 | 220 |
| N6120083 | 208 | N6356478 | 118 | N6520024 | 218 |
| N6120088 | 216 | N6356479 | 118 | N6520025 | 218 |
| N6120089 | 216 | N6356558 | 119 | N6520026 | 219 |
| N6120090 | 218 | N6356559 | 119 | N6520027 | 219 |
| N6120091 | 218 | N6356560 | 119 | N6520028 | 216 |
| N6120092 | 218 | N6356561 | 119 | N6520029 | 216 |
| N6120093 | 218 | N6356562 | 119 | N6520270 | 202 |
| N6120094 | 218 | N6356563 | 119 | N6520271 | 202 |
| N6120095 | 216 | N6356564 | 119 | N6520272 | 202 |
| N6120098 | 208 | N6356566 | 119 | N6520273 | 202 |
| N6120100 | 206 | N6470012 | 207, 221, 223 | N6621006 | 121 |
| N6120101 | 205 | N6480080 | 223 | N6621008 | 121 |
| N6120102 | 209 | N6480081 | 223 | N6621009 | 121 |
| N6120122 | 217 | N6480082 | 223 | N6621028 | 204, 206, 207, 208, 209, 213 |
| N6120123 | 217 | N6480130 | 223 | N6621035 | 121 |
| N6120124 | 220 | N6480132 | 223 | N6621036 | 121 |
| N6120125 | 220 | N6480140 | 223 | N6621037 | 121 |
| N6120126 | 218 | N6480141 | 223 | N6621038 | 121 |
| N6120127 | 218 | N6480142 | 223 | N6700113 | 228 |
| N6120128 | 216 | N6480143 | 223 | N6700130 | 228 |
| N6120129 | 216 | N6480144 | 223 | N6701170 | 228 |
| N6120130 | 219 | N6480145 | 223 | N6710188 | 225 |
| N6120131 | 219 | N6480146 | 223 | N8102011 | 48 |
| N6120136 | 206 | N6480147 | 223 | N8120100 | 54, 55 |
| N6120137 | 206 | N6480148 | 223 | N8120116 | 54 |
| N6120138 | 205 | N6480149 | 223 | N8120124 | 52 |
| N6120139 | 205 | N6480151 | 223 | N8120150 | 52 |
| N6120140 | 209 | N6480153 | 223 | N8120511 | 57, 58 |
| N6120141 | 209 | N6480154 | 223 | N8120512 | 57, 58 |
| N6120142 | 208 | N6480360 | 222 | N8120515 | 48, 58 |
| N6120143 | 208 | N6480361 | 222 | N8120516 | 48 |
| N6120150 | 220 | N6480362 | 222 | N8120518 | 58 |
| N6120161 | 214, 215 | N6480380 | 222 | N8120519 | 58 |
| N6120162 | 214 | N6482024 | 222 | N8120522 | 78 |
| N6120165 | 214 | N6502000 | 211 | N8120541 | 78 |
| N6120166 | 214 | N6502001 | 211 | N8120610 | 58 |
| N6120167 | 214 | N6502002 | 211 | N8120611 | 58 |
| N6120168 | 214 | N6502003 | 210 | N8121036 | 34, 48 |
| N6121000 | 206 | N6502004 | 210 | N8121037 | 48 |
| N6121001 | 204, 210 | N6502005 | 210 | N8121038 | 48 |
| N6121002 | 204, 210 | N6502006 | 210 | N8121039 | 48 |
| N6121003 | 211 | N6502009 | 210 | N8121045 | 49 |
| N6121004 | 207, 209, 211 | N6502010 | 210 | N8121046 | 49 |
| N6121006 | 209, 211 | N6502011 | 210 | N8121056 | 49 |
| N6121008 | 211 | N6502012 | 210 | N8121057 | 49 |
| N6121009 | 211 | N6502013 | 211 | N8121061 | 49 |
| N6121020 | 204, 210 | N6502014 | 211 | N8121068 | 88 |
| N6121021 | 204, 210 | N6502015 | 211 | N8121069 | 47, 88 |
| N6121022 | 204, 210, 211 | N6502016 | 211 | N8121086 | 57 |
| N6200119 | 225 | N6502017 | 211 | N8122004 | 56 |

PART NUMBER INDEX

| Part No. | Page | Part No. | Page | Part No. | Page |
|----------|------------|----------|--------|----------|--------|
| N8122006 | 55, 58, 59 | N8142098 | 48 | N8145163 | 62 |
| N8122007 | 54 | N8142300 | 77 | N8145164 | 62 |
| N8122010 | 54, 55 | N8142301 | 77 | N8145165 | 62 |
| N8122012 | 60 | N8142302 | 77 | N8145166 | 62 |
| N8122014 | 78 | N8142303 | 77 | N8145167 | 62 |
| N8122017 | 78 | N8142304 | 77 | N8145168 | 62 |
| N8122038 | 78, 81 | N8142305 | 77 | N8145169 | 62 |
| N8122188 | 52 | N8142306 | 77 | N8145170 | 62 |
| N8122192 | 50 | N8142307 | 77 | N8145171 | 62 |
| N8122239 | 48 | N8145000 | 56 | N8145172 | 62 |
| N8122247 | 87 | N8145003 | 56 | N8145173 | 62 |
| N8122248 | 87 | N8145011 | 48 | N8145174 | 62 |
| N8122308 | 56 | N8145012 | 48 | N8145175 | 62 |
| N8122356 | 52 | N8145013 | 51 | N8145176 | 62 |
| N8122358 | 54 | N8145013 | 59 | N8145177 | 62 |
| N8122359 | 54 | N8145014 | 51, 59 | N8145178 | 62 |
| N8122382 | 36, 50 | N8145015 | 48, 59 | N8145179 | 62 |
| N8122383 | 36, 50 | N8145016 | 48, 59 | N8145180 | 62 |
| N8122384 | 36, 50 | N8145017 | 48, 59 | N8145181 | 62 |
| N8122389 | 53 | N8145018 | 48, 59 | N8145182 | 62 |
| N8122394 | 54 | N8145022 | 59 | N8145183 | 62 |
| N8122410 | 53 | N8145050 | 80, 81 | N8145184 | 62 |
| N8122411 | 54 | N8145051 | 78, 80 | N8145185 | 62 |
| N8122412 | 54 | N8145052 | 80 | N8145186 | 62 |
| N8122413 | 54 | N8145053 | 80 | N8145187 | 62 |
| N8122452 | 53 | N8145054 | 80 | N8145188 | 62 |
| N8122460 | 48 | N8145055 | 80 | N8145189 | 62 |
| N8122461 | 48 | N8145056 | 80 | N8145190 | 62 |
| N8122462 | 48 | N8145057 | 80 | N8145191 | 62 |
| N8125001 | 56 | N8145058 | 80 | N8145192 | 62 |
| N8125010 | 78 | N8145059 | 80 | N8145193 | 62 |
| N8125029 | 54, 58 | N8145060 | 80 | N8145194 | 62 |
| N8125030 | 78 | N8145061 | 80 | N8145195 | 62 |
| N8125031 | 78 | N8145099 | 53 | N8145196 | 62 |
| N8125032 | 78 | N8145101 | 50 | N8145197 | 62 |
| N8125033 | 78, 81 | N8145106 | 55 | N8145198 | 62 |
| N8125034 | 78 | N8145119 | 52 | N8145199 | 62 |
| N8125035 | 78 | N8145120 | 52 | N8145200 | 62 |
| N8125037 | 78, 80 | N8145121 | 52 | N8145201 | 62 |
| N8125038 | 78, 80 | N8145122 | 52 | N8145202 | 62 |
| N8125039 | 80 | N8145135 | 36, 50 | N8145203 | 62 |
| N8125040 | 78 | N8145136 | 36, 50 | N8145204 | 62 |
| N8125041 | 78 | N8145137 | 36, 50 | N8145205 | 62 |
| N8125050 | 56 | N8145138 | 36, 50 | N8145206 | 62 |
| N8126039 | 54 | N8145145 | 62 | N8145207 | 62 |
| N8126040 | 54 | N8145146 | 62 | N8145208 | 62 |
| N8126041 | 54, 58 | N8145147 | 62 | N8145209 | 62 |
| N8140503 | 80 | N8145148 | 62 | N8145210 | 62 |
| N8140504 | 80 | N8145149 | 62 | N8145211 | 62 |
| N8140507 | 50 | N8145150 | 62 | N8145212 | 62 |
| N8140513 | 59 | N8145151 | 62 | N8145213 | 62 |
| N8140514 | 59 | N8145152 | 62 | N8145214 | 62 |
| N8140527 | 55 | N8145153 | 62 | N8145215 | 62 |
| N8140536 | 55 | N8145154 | 62 | N8145216 | 62 |
| N8141206 | 59 | N8145155 | 62 | N8145217 | 62 |
| N8141230 | 47, 123 | N8145156 | 62 | N8145218 | 62 |
| N8141420 | 52 | N8145157 | 62 | N8145219 | 62 |
| N8141426 | 53 | N8145158 | 62 | N8145220 | 62 |
| N8142000 | 52 | N8145159 | 62 | N8145236 | 36, 50 |
| N8142001 | 50 | N8145160 | 62 | N8145284 | 78, 80 |
| N8142002 | 50 | N8145161 | 62 | N8145289 | 80 |
| N8142003 | 53 | N8145162 | 62 | N8145309 | 53 |

| Part No. | Page | Part No. | Page | Part No. | Page |
|----------|------------|----------|------------|----------|------------|
| N8145310 | 53 | N9300119 | 68 | N9300183 | 68 |
| N8145318 | 55 | N9300120 | 68 | N9300184 | 68, 75, 76 |
| N8145319 | 57 | N9300121 | 68 | N9300200 | 72, 76 |
| N8145320 | 57 | N9300122 | 68 | N9300201 | 72, 76 |
| N8145321 | 52 | N9300123 | 68 | N9300202 | 72, 76 |
| N8145322 | 77 | N9300124 | 68 | N9300203 | 72, 76 |
| N8145323 | 77 | N9300125 | 68 | N9300204 | 72, 76 |
| N8145324 | 77 | N9300126 | 68, 75, 76 | N9300205 | 76, 79 |
| N8145340 | 53 | N9300127 | 68 | N9300207 | 68, 76, 79 |
| N8145407 | 88 | N9300128 | 68 | N9300208 | 76, 79 |
| N9300030 | 201 | N9300129 | 68, 75 | N9300211 | 76 |
| N9300031 | 201 | N9300130 | 68 | N9300212 | 76 |
| N9300032 | 201 | N9300131 | 68, 75 | N9300213 | 76 |
| N9300033 | 201 | N9300132 | 68, 75 | N9300214 | 76 |
| N9300036 | 201 | N9300133 | 68 | N9300215 | 76 |
| N9300037 | 201 | N9300134 | 68 | N9300216 | 76 |
| N9300038 | 201 | N9300135 | 68 | N9300217 | 76 |
| N9300039 | 201 | N9300136 | 68, 75 | N9300218 | 75, 79 |
| N9300040 | 201 | N9300137 | 68 | N9300219 | 75, 79 |
| N9300041 | 201 | N9300138 | 68 | N9300220 | 75, 79 |
| N9300042 | 201 | N9300139 | 68 | N9300221 | 75, 79 |
| N9300043 | 201 | N9300140 | 68 | N9300223 | 76 |
| N9300044 | 201 | N9300141 | 68, 75, 76 | N9300224 | 79 |
| N9300046 | 201 | N9300142 | 68 | N9300225 | 80 |
| N9300047 | 201 | N9300143 | 68 | N9300226 | 75, 76, 79 |
| N9300048 | 201 | N9300144 | 68 | N9300227 | 75, 76, 79 |
| N9300049 | 201 | N9300145 | 68 | N9300228 | 75, 79 |
| N9300050 | 201 | N9300146 | 68 | N9300229 | 75, 79 |
| N9300051 | 201 | N9300147 | 68 | N9300230 | 72 |
| N9300053 | 201 | N9300148 | 68 | N9300231 | 71 |
| N9300054 | 201 | N9300148 | 75 | N9300232 | 71, 81 |
| N9300055 | 201, 204 | N9300149 | 68 | N9300233 | 71, 81 |
| N9300056 | 201, 204 | N9300150 | 69 | N9300234 | 71, 81 |
| N9300057 | 201 | N9300151 | 69 | N9300235 | 71, 75, 81 |
| N9300058 | 201 | N9300152 | 69, 75, 76 | N9300236 | 71 |
| N9300059 | 201, 228 | N9300153 | 69, 75 | N9300238 | 71, 81 |
| N9300060 | 201 | N9300154 | 69 | N9300239 | 71 |
| N9300061 | 201 | N9300155 | 69 | N9300241 | 77 |
| N9300065 | 24 | N9300156 | 69 | N9300244 | 73 |
| N9300068 | 90 | N9300157 | 69 | N9300253 | 74, 81 |
| N9300081 | 243 | N9300158 | 69 | N9300260 | 73 |
| N9300086 | 265 | N9300160 | 69 | N9300280 | 72 |
| N9300096 | 216 | N9300161 | 69, 75 | N9300281 | 72 |
| N9300100 | 68, 75 | N9300162 | 69, 75 | N9300283 | 70 |
| N9300101 | 68, 75 | N9300163 | 69 | N9300500 | 117 |
| N9300102 | 68 | N9300165 | 69, 75 | N9300501 | 117 |
| N9300103 | 68 | N9300166 | 69 | N9300502 | 117 |
| N9300104 | 68 | N9300167 | 69, 75 | N9300503 | 117 |
| N9300105 | 68 | N9300168 | 69 | N9300650 | 117 |
| N9300106 | 68 | N9300169 | 69 | N9300651 | 30 |
| N9300107 | 68 | N9300170 | 69 | N9300695 | 117, 168 |
| N9300108 | 68, 75, 76 | N9300171 | 69 | N9300696 | 117 |
| N9300109 | 68 | N9300172 | 68 | N9300697 | 117 |
| N9300110 | 68 | N9300173 | 68 | N9300698 | 117 |
| N9300111 | 68 | N9300174 | 68 | N9300699 | 117 |
| N9300112 | 68, 75 | N9300175 | 68 | N9300700 | 117 |
| N9300113 | 68 | N9300176 | 68 | N9300701 | 117 |
| N9300114 | 68, 75 | N9300177 | 68 | N9300702 | 117 |
| N9300115 | 68 | N9300178 | 69 | N9300703 | 115 |
| N9300116 | 68 | N9300179 | 68, 75, 76 | N9300704 | 115 |
| N9300117 | 68 | N9300180 | 68 | N9300705 | 115 |
| N9300118 | 68 | N9300181 | 68 | N9300706 | 115 |

PART NUMBER INDEX

| Part No. | Page | Part No. | Page | Part No. | Page |
|----------|---------------|----------|---------------|----------|------------|
| N9300707 | 117, 123 | N9301712 | 91 | N9302782 | 204, 207 |
| N9300708 | 117, 123 | N9301714 | 91 | N9302783 | 204, 207 |
| N9300709 | 114, 115 | N9301715 | 91 | N9302784 | 116 |
| N9300710 | 114, 115 | N9301720 | 71 | N9302785 | 120, 121 |
| N9300711 | 114, 115 | N9301721 | 74, 78 | N9302832 | 228 |
| N9300712 | 114, 115 | N9301735 | 117 | N9302945 | 115 |
| N9300713 | 114, 115 | N9301736 | 117 | N9302946 | 78 |
| N9300714 | 114, 115 | N9301945 | 117 | N9302972 | 213 |
| N9300715 | 114, 115 | N9302130 | 115 | N9302974 | 243 |
| N9300716 | 114, 115 | N9302134 | 118 | N9302975 | 119 |
| N9300717 | 114, 115 | N9302136 | 115 | N9302976 | 119 |
| N9300718 | 114, 115 | N9302139 | 116 | N9302977 | 119 |
| N9300719 | 117, 123 | N9302140 | 116 | N9302978 | 119 |
| N9300720 | 117, 123 | N9302141 | 116 | N9302979 | 119 |
| N9300850 | 86, 262 | N9302149 | 200 | N9302980 | 119 |
| N9300901 | 120 | N9302197 | 91 | N9302981 | 119 |
| N9300902 | 120 | N9302199 | 91 | N9303139 | 229 |
| N9300903 | 120 | N9302202 | 212 | N9303201 | 237 |
| N9301001 | 162 | N9302203 | 212 | N9303202 | 237 |
| N9301002 | 162 | N9302210 | 212 | N9303203 | 237 |
| N9301029 | 161 | N9302211 | 212 | N9303204 | 237 |
| N9301167 | 200 | N9302212 | 212 | N9303205 | 239 |
| N9301178 | 233 | N9302213 | 212 | N9303206 | 239 |
| N9301179 | 233 | N9302222 | 212 | N9303207 | 239 |
| N9301191 | 233 | N9302224 | 212 | N9303208 | 239 |
| N9301192 | 233 | N9302226 | 212 | N9303209 | 239 |
| N9301193 | 233 | N9302230 | 212 | N9303210 | 239 |
| N9301205 | 65 | N9302231 | 112 | N9303211 | 239 |
| N9301208 | 123, 233 | N9302235 | 112 | N9303212 | 239 |
| N9301221 | 201 | N9302555 | 123, 164 | N9303223 | 171 |
| N9301222 | 201 | N9302560 | 123, 164, 167 | N9303224 | 171 |
| N9301223 | 201 | N9302561 | 167 | N9303225 | 236 |
| N9301225 | 201 | N9302562 | 123, 164, 167 | N9303226 | 236 |
| N9301226 | 201 | N9302563 | 167 | N9303227 | 236 |
| N9301227 | 201 | N9302564 | 167 | N9303343 | 213 |
| N9301233 | 201 | N9302565 | 167 | N9303344 | 204, 213 |
| N9301253 | 201 | N9302600 | 264 | N9303345 | 204 |
| N9301254 | 201 | N9302603 | 264 | N9303348 | 118 |
| N9301255 | 201 | N9302605 | 264 | N9303349 | 118 |
| N9301259 | 201 | N9302609 | 264 | N9303350 | 119 |
| N9301266 | 201 | N9302610 | 264 | N9303351 | 118 |
| N9301268 | 201 | N9302611 | 264 | N9303352 | 118 |
| N9301269 | 201 | N9302612 | 264 | N9303396 | 147 |
| N9301270 | 121 | N9302614 | 264 | N9303416 | 116 |
| N9301272 | 214 | N9302615 | 264 | N9303417 | 116 |
| N9301303 | 117, 121 | N9302619 | 264 | N9303418 | 115 |
| N9301304 | 121 | N9302620 | 258 | N9303419 | 116 |
| N9301326 | 168 | N9302622 | 264 | N9303429 | 243 |
| N9301327 | 242 | N9302640 | 258 | N9303430 | 131 |
| N9301328 | 242 | N9302642 | 258 | N9303441 | 116 |
| N9301343 | 200 | N9302643 | 258 | N9303442 | 116 |
| N9301356 | 228 | N9302650 | 161, 168 | N9303445 | 29, 31, 73 |
| N9301357 | 228 | N9302677 | 166 | N9303448 | 200 |
| N9301376 | 200, 214 | N9302678 | 161 | N9303449 | 116 |
| N9301385 | 114, 115, 117 | N9302679 | 115 | N9303500 | 130 |
| N9301385 | 114 | N9302680 | 115, 117 | N9303501 | 130 |
| N9301390 | 117, 121 | N9302681 | 114 | N9303502 | 130 |
| N9301398 | 91 | N9302682 | 114 | N9303503 | 130 |
| N9301399 | 91 | N9302684 | 116, 117 | N9303504 | 130 |
| N9301480 | 168 | N9302685 | 116, 117 | N9303505 | 130 |
| N9301710 | 91 | N9302686 | 116, 117 | N9303506 | 130 |
| N9301711 | 91 | N9302780 | 114, 117 | N9303507 | 129 |

| Part No. | Page | Part No. | Page | Part No. | Page |
|---------------|------|---------------|------|---------------|------|
| N9303508..... | 129 | N9303572..... | 140 | N9303663..... | 135 |
| N9303509..... | 129 | N9303573..... | 140 | N9303664..... | 135 |
| N9303510..... | 129 | N9303574..... | 140 | N9303665..... | 135 |
| N9303511..... | 129 | N9303575..... | 140 | N9303666..... | 143 |
| N9303512..... | 129 | N9303576..... | 140 | N9303667..... | 143 |
| N9303513..... | 129 | N9303577..... | 140 | N9303668..... | 143 |
| N9303514..... | 129 | N9303578..... | 140 | N9303669..... | 143 |
| N9303515..... | 130 | N9303598..... | 140 | N9303670..... | 143 |
| N9303516..... | 130 | N9303599..... | 140 | N9303671..... | 143 |
| N9303517..... | 130 | N9303600..... | 140 | N9303672..... | 143 |
| N9303518..... | 130 | N9303601..... | 140 | N9303673..... | 143 |
| N9303519..... | 130 | N9303602..... | 140 | N9303674..... | 142 |
| N9303520..... | 130 | N9303603..... | 140 | N9303675..... | 142 |
| N9303521..... | 130 | N9303604..... | 140 | N9303676..... | 142 |
| N9303522..... | 130 | N9303605..... | 140 | N9303677..... | 142 |
| N9303523..... | 130 | N9303606..... | 140 | N9303678..... | 142 |
| N9303524..... | 130 | N9303607..... | 140 | N9303679..... | 142 |
| N9303525..... | 131 | N9303613..... | 137 | N9303680..... | 142 |
| N9303526..... | 131 | N9303614..... | 137 | N9303681..... | 142 |
| N9303527..... | 131 | N9303615..... | 137 | N9303682..... | 142 |
| N9303528..... | 131 | N9303616..... | 137 | N9303683..... | 142 |
| N9303529..... | 131 | N9303617..... | 137 | N9303684..... | 142 |
| N9303530..... | 131 | N9303618..... | 137 | N9303685..... | 142 |
| N9303531..... | 131 | N9303619..... | 137 | N9303686..... | 142 |
| N9303532..... | 140 | N9303625..... | 136 | N9303687..... | 142 |
| N9303533..... | 140 | N9303626..... | 136 | N9303688..... | 143 |
| N9303534..... | 140 | N9303627..... | 136 | N9303689..... | 143 |
| N9303535..... | 140 | N9303628..... | 136 | N9303690..... | 143 |
| N9303536..... | 140 | N9303629..... | 136 | N9303691..... | 143 |
| N9303537..... | 139 | N9303630..... | 136 | N9303693..... | 143 |
| N9303538..... | 139 | N9303631..... | 137 | N9303694..... | 143 |
| N9303539..... | 139 | N9303632..... | 137 | N9303695..... | 143 |
| N9303540..... | 139 | N9303633..... | 137 | N9303696..... | 143 |
| N9303541..... | 139 | N9303634..... | 137 | N9303697..... | 143 |
| N9303542..... | 139 | N9303635..... | 137 | N9303698..... | 143 |
| N9303543..... | 139 | N9303636..... | 137 | N9303699..... | 143 |
| N9303544..... | 139 | N9303637..... | 137 | N9303700..... | 143 |
| N9303545..... | 139 | N9303638..... | 137 | N9303701..... | 143 |
| N9303546..... | 139 | N9303639..... | 137 | N9303702..... | 143 |
| N9303547..... | 139 | N9303640..... | 137 | N9303703..... | 143 |
| N9303548..... | 139 | N9303641..... | 137 | N9303704..... | 143 |
| N9303549..... | 139 | N9303642..... | 137 | N9303705..... | 143 |
| N9303550..... | 139 | N9303643..... | 137 | N9303706..... | 143 |
| N9303551..... | 139 | N9303644..... | 137 | N9303707..... | 143 |
| N9303552..... | 139 | N9303645..... | 137 | N9303708..... | 143 |
| N9303553..... | 139 | N9303646..... | 135 | N9303709..... | 143 |
| N9303554..... | 139 | N9303647..... | 135 | N9303710..... | 143 |
| N9303557..... | 139 | N9303648..... | 135 | N9303711..... | 142 |
| N9303558..... | 139 | N9303649..... | 135 | N9303712..... | 142 |
| N9303559..... | 139 | N9303650..... | 135 | N9303713..... | 142 |
| N9303560..... | 139 | N9303651..... | 135 | N9303714..... | 142 |
| N9303561..... | 139 | N9303652..... | 135 | N9303715..... | 142 |
| N9303562..... | 139 | N9303653..... | 135 | N9303716..... | 142 |
| N9303563..... | 139 | N9303654..... | 135 | N9303717..... | 142 |
| N9303564..... | 139 | N9303655..... | 135 | N9303718..... | 138 |
| N9303565..... | 139 | N9303656..... | 135 | N9303719..... | 138 |
| N9303566..... | 139 | N9303657..... | 135 | N9303720..... | 138 |
| N9303567..... | 139 | N9303658..... | 135 | N9303721..... | 138 |
| N9303568..... | 139 | N9303659..... | 135 | N9303722..... | 143 |
| N9303569..... | 141 | N9303660..... | 135 | N9303723..... | 143 |
| N9303570..... | 141 | N9303661..... | 135 | N9303725..... | 69 |
| N9303571..... | 141 | N9303662..... | 135 | N9303726..... | 68 |

PART NUMBER INDEX

| Part No. | Page | Part No. | Page | Part No. | Page |
|----------|--------|----------|--------|----------|----------|
| N9303727 | 68 | N9303785 | 69 | N9303868 | 143 |
| N9303728 | 68 | N9303786 | 68 | N9303869 | 133 |
| N9303729 | 68 | N9303787 | 68 | N9303870 | 133 |
| N9303730 | 68 | N9303788 | 68 | N9303871 | 133 |
| N9303731 | 68 | N9303789 | 68 | N9303872 | 142 |
| N9303731 | 70 | N9303790 | 68 | N9303873 | 143 |
| N9303732 | 81 | N9303791 | 68 | N9303877 | 142 |
| N9303733 | 68 | N9303792 | 68 | N9303878 | 143 |
| N9303734 | 68 | N9303793 | 68 | N9303879 | 134 |
| N9303735 | 68 | N9303794 | 68 | N9303880 | 134 |
| N9303736 | 68 | N9303795 | 68 | N9303882 | 142 |
| N9303737 | 68 | N9303796 | 69 | N9303883 | 143 |
| N9303738 | 68 | N9303797 | 79 | N9303884 | 137 |
| N9303739 | 68 | N9303798 | 68 | N9303885 | 137 |
| N9303739 | 70 | N9303799 | 69 | N9303886 | 141 |
| N9303740 | 68 | N9303800 | 68 | N9303887 | 132, 133 |
| N9303741 | 68 | N9303801 | 69 | N9303888 | 132, 133 |
| N9303741 | 70 | N9303802 | 69 | N9303889 | 132, 133 |
| N9303742 | 68 | N9303803 | 69 | N9303890 | 132, 133 |
| N9303743 | 68 | N9303804 | 69 | N9303891 | 132, 133 |
| N9303744 | 68 | N9303805 | 69 | N9303892 | 132, 133 |
| N9303745 | 68 | N9303806 | 69 | N9303893 | 142 |
| N9303746 | 69 | N9303807 | 69 | N9303894 | 143 |
| N9303747 | 68 | N9303808 | 69 | N9303895 | 134 |
| N9303748 | 68 | N9303809 | 69 | N9303896 | 134 |
| N9303749 | 68 | N9303810 | 69 | N9303897 | 134 |
| N9303749 | 70 | N9303811 | 69 | N9303898 | 134 |
| N9303750 | 68 | N9303812 | 69 | N9303899 | 134 |
| N9303751 | 68 | N9303813 | 81 | N9303900 | 134 |
| N9303751 | 70 | N9303814 | 71, 81 | N9303901 | 142 |
| N9303752 | 68 | N9303816 | 74, 78 | N9303902 | 143 |
| N9303753 | 69 | N9303818 | 78 | N9303903 | 132 |
| N9303753 | 70 | N9303819 | 74 | N9303904 | 132 |
| N9303754 | 69 | N9303821 | 74, 79 | N9303905 | 132 |
| N9303755 | 69 | N9303822 | 74, 79 | N9303906 | 132 |
| N9303756 | 69 | N9303823 | 74, 79 | N9303907 | 132 |
| N9303757 | 69, 70 | N9303824 | 74, 79 | N9303908 | 132 |
| N9303758 | 69 | N9303825 | 78 | N9303909 | 142 |
| N9303759 | 68 | N9303826 | 78 | N9303910 | 143 |
| N9303761 | 68 | N9303827 | 75 | N9303911 | 132, 133 |
| N9303763 | 68 | N9303828 | 79 | N9303912 | 132, 133 |
| N9303764 | 70 | N9303829 | 75 | N9303913 | 132, 133 |
| N9303765 | 68 | N9303830 | 79 | N9303914 | 134 |
| N9303766 | 68 | N9303831 | 79 | N9303915 | 134 |
| N9303767 | 68 | N9303832 | 80 | N9303916 | 134 |
| N9303768 | 68 | N9303833 | 80 | N9303917 | 132 |
| N9303769 | 68 | N9303834 | 80 | N9303918 | 132 |
| N9303770 | 68 | N9303835 | 75 | N9303919 | 132 |
| N9303771 | 68 | N9303836 | 75 | N9303920 | 133 |
| N9303772 | 68 | N9303837 | 72 | N9303921 | 133 |
| N9303773 | 68 | N9303838 | 69 | N9303922 | 133 |
| N9303774 | 68 | N9303839 | 75 | N9303931 | 130 |
| N9303775 | 68 | N9303840 | 72, 75 | N9303932 | 130 |
| N9303776 | 68 | N9303840 | 75 | N9303935 | 136 |
| N9303777 | 68 | N9303841 | 72 | N9303936 | 136 |
| N9303778 | 68 | N9303842 | 69 | N9303937 | 136 |
| N9303779 | 68 | N9303843 | 74, 78 | N9303938 | 143 |
| N9303780 | 68 | N9303844 | 69 | N9303940 | 71, 137 |
| N9303781 | 68 | N9303847 | 140 | N9303941 | 71, 137 |
| N9303782 | 68 | N9303848 | 139 | N9303942 | 71, 137 |
| N9303783 | 68 | N9303851 | 138 | N9303943 | 71, 143 |
| N9303784 | 68 | N9303867 | 142 | N9303944 | 71 |

| Part No. | Page | Part No. | Page | Part No. | Page |
|----------|----------|----------|------|----------|------|
| N9303945 | 72 | N9304153 | 77 | N9304254 | 69 |
| N9303946 | 72 | N9304154 | 77 | N9304255 | 69 |
| N9303948 | 72 | N9304155 | 77 | N9304256 | 69 |
| N9303949 | 72 | N9304156 | 77 | N9304257 | 69 |
| N9303952 | 76 | N9304157 | 77 | N9304258 | 69 |
| N9303953 | 79 | N9304158 | 77 | N9304259 | 69 |
| N9303954 | 72 | N9304159 | 77 | N9304260 | 69 |
| N9303955 | 81 | N9304160 | 77 | N9304261 | 69 |
| N9303962 | 200 | N9304168 | 83 | N9304262 | 69 |
| N9303963 | 229 | N9304200 | 69 | N9304263 | 69 |
| N9303964 | 229 | N9304201 | 69 | N9304264 | 69 |
| N9303970 | 134 | N9304202 | 69 | N9304265 | 69 |
| N9303971 | 134 | N9304203 | 69 | N9304266 | 69 |
| N9303972 | 134 | N9304204 | 69 | N9304267 | 70 |
| N9303973 | 133 | N9304205 | 69 | N9304268 | 70 |
| N9303974 | 133 | N9304206 | 69 | N9304269 | 70 |
| N9303975 | 133 | N9304207 | 69 | N9304270 | 70 |
| N9303981 | 134 | N9304208 | 69 | N9304271 | 70 |
| N9303990 | 120 | N9304209 | 69 | N9304272 | 70 |
| N9303991 | 120 | N9304210 | 69 | N9304273 | 70 |
| N9303992 | 120 | N9304211 | 69 | N9304274 | 70 |
| N9303993 | 120 | N9304212 | 69 | N9304275 | 70 |
| N9303995 | 134 | N9304213 | 69 | N9304276 | 70 |
| N9303996 | 134 | N9304214 | 69 | N9304277 | 70 |
| N9304110 | 70 | N9304215 | 69 | N9304278 | 70 |
| N9304111 | 70 | N9304216 | 69 | N9304279 | 70 |
| N9304112 | 70 | N9304217 | 69 | N9304280 | 70 |
| N9304113 | 70 | N9304218 | 69 | N9304281 | 70 |
| N9304114 | 70 | N9304219 | 69 | N9304282 | 70 |
| N9304115 | 70 | N9304220 | 69 | N9304283 | 70 |
| N9304116 | 70 | N9304221 | 69 | N9304284 | 70 |
| N9304117 | 70 | N9304222 | 69 | N9304285 | 70 |
| N9304118 | 70 | N9304223 | 69 | N9304286 | 70 |
| N9304119 | 70 | N9304224 | 69 | N9304287 | 70 |
| N9304120 | 70 | N9304225 | 69 | N9304288 | 70 |
| N9304121 | 70 | N9304226 | 69 | N9304289 | 70 |
| N9304122 | 70 | N9304227 | 69 | N9304290 | 70 |
| N9304123 | 70 | N9304228 | 69 | N9304291 | 70 |
| N9304124 | 70 | N9304229 | 69 | N9304292 | 70 |
| N9304125 | 70 | N9304230 | 69 | N9304294 | 70 |
| N9304126 | 70 | N9304231 | 69 | N9304295 | 70 |
| N9304127 | 71 | N9304232 | 69 | N9304296 | 70 |
| N9304128 | 71 | N9304233 | 69 | N9304297 | 70 |
| N9304129 | 71 | N9304234 | 69 | N9304298 | 70 |
| N9304130 | 72 | N9304235 | 69 | N9304299 | 70 |
| N9304131 | 72 | N9304236 | 69 | N9304300 | 70 |
| N9304135 | 114, 115 | N9304237 | 69 | N9304301 | 70 |
| N9304136 | 114, 115 | N9304238 | 69 | N9304302 | 70 |
| N9304137 | 114, 115 | N9304239 | 69 | N9304303 | 70 |
| N9304138 | 114, 115 | N9304240 | 69 | N9304304 | 70 |
| N9304139 | 114, 115 | N9304241 | 69 | N9304305 | 70 |
| N9304140 | 114, 115 | N9304242 | 69 | N9304306 | 70 |
| N9304141 | 114 | N9304243 | 69 | N9304307 | 70 |
| N9304142 | 114 | N9304244 | 69 | N9304308 | 70 |
| N9304143 | 119 | N9304245 | 69 | N9304309 | 70 |
| N9304144 | 119 | N9304247 | 69 | N9304310 | 70 |
| N9304145 | 119 | N9304248 | 69 | N9304311 | 70 |
| N9304146 | 119 | N9304249 | 69 | N9304312 | 70 |
| N9304147 | 119 | N9304250 | 69 | N9304313 | 70 |
| N9304150 | 77 | N9304251 | 69 | N9304314 | 70 |
| N9304151 | 77 | N9304252 | 69 | N9304315 | 70 |
| N9304152 | 77 | N9304253 | 69 | N9304316 | 70 |

PART NUMBER INDEX

| Part No. | Page | Part No. | Page | Part No. | Page |
|----------|----------|----------|----------|----------|------|
| N9304317 | 70 | N9304611 | 32 | N9305638 | 177 |
| N9304318 | 70 | N9304612 | 32 | N9305639 | 177 |
| N9304319 | 70 | N9304613 | 32 | N9305640 | 177 |
| N9304320 | 70 | N9304614 | 32 | N9305641 | 177 |
| N9304321 | 70 | N9304615 | 32 | N9305642 | 177 |
| N9304322 | 70 | N9304616 | 32 | N9305643 | 177 |
| N9304323 | 70 | N9304617 | 32 | N9305644 | 177 |
| N9304324 | 70 | N9304618 | 32 | N9305645 | 177 |
| N9304325 | 70 | N9304619 | 32 | N9305646 | 177 |
| N9304326 | 70 | N9304620 | 32 | N9305647 | 177 |
| N9304327 | 70 | N9304621 | 32 | N9305648 | 177 |
| N9304328 | 70 | N9304622 | 32 | N9305649 | 177 |
| N9304329 | 70 | N9304623 | 32 | N9305650 | 177 |
| N9304330 | 70 | N9304624 | 32 | N9305651 | 177 |
| N9304331 | 70 | N9304625 | 32 | N9305652 | 177 |
| N9304332 | 70 | N9304626 | 32 | N9305653 | 177 |
| N9304333 | 70 | N9304627 | 32 | N9305654 | 177 |
| N9304334 | 70 | N9304628 | 32 | N9305655 | 179 |
| N9304335 | 70 | N9304629 | 32 | N9305656 | 179 |
| N9304336 | 70 | N9304630 | 32 | N9305657 | 179 |
| N9304337 | 70 | N9304631 | 32 | N9305658 | 179 |
| N9304338 | 70 | N9304632 | 32 | N9305659 | 179 |
| N9304339 | 70 | N9304633 | 32 | N9305660 | 179 |
| N9304340 | 70 | N9304634 | 32 | N9305661 | 179 |
| N9304341 | 70 | N9305600 | 173 | N9305662 | 179 |
| N9304342 | 70 | N9305601 | 173 | N9305663 | 179 |
| N9304343 | 70 | N9305602 | 173 | N9305664 | 179 |
| N9304344 | 70 | N9305603 | 173 | N9305665 | 179 |
| N9304345 | 70 | N9305604 | 173 | N9305666 | 179 |
| N9304346 | 70 | N9305605 | 173 | N9305667 | 179 |
| N9304347 | 70 | N9305606 | 173 | N9305668 | 179 |
| N9304348 | 70 | N9305607 | 173 | N9305669 | 179 |
| N9304349 | 70 | N9305608 | 173 | N9305670 | 179 |
| N9304350 | 70 | N9305609 | 173 | N9305671 | 179 |
| N9304351 | 71 | N9305610 | 173 | N9305672 | 179 |
| N9304352 | 71 | N9305611 | 173 | N9305673 | 179 |
| N9304353 | 71 | N9305612 | 173 | N9305674 | 179 |
| N9304354 | 71 | N9305613 | 173 | N9305675 | 179 |
| N9304355 | 71 | N9305614 | 173 | N9305677 | 181 |
| N9304356 | 71 | N9305615 | 173 | N9305678 | 181 |
| N9304357 | 71 | N9305616 | 173 | N9305679 | 181 |
| N9304358 | 71 | N9305617 | 173 | N9305680 | 181 |
| N9304359 | 71 | N9305618 | 173 | N9305681 | 181 |
| N9304360 | 71 | N9305619 | 173 | N9305682 | 181 |
| N9304500 | 117, 121 | N9305620 | 173 | N9305683 | 181 |
| N9304501 | 121 | N9305621 | 173 | N9305684 | 181 |
| N9304502 | 121 | N9305622 | 173 | N9305685 | 181 |
| N9304503 | 121 | N9305623 | 173 | N9305686 | 182 |
| N9304550 | 123 | N9305624 | 173 | N9305687 | 182 |
| N9304551 | 123 | N9305625 | 173 | N9305688 | 182 |
| N9304552 | 123 | N9305626 | 173 | N9305689 | 182 |
| N9304553 | 123 | N9305627 | 173 | N9305690 | 182 |
| N9304554 | 123 | N9305628 | 173 | N9305691 | 182 |
| N9304555 | 123 | N9305629 | 173 | N9305692 | 182 |
| N9304556 | 123 | N9305630 | 173 | N9305693 | 182 |
| N9304557 | 123 | N9305631 | 173, 184 | N9305694 | 182 |
| N9304600 | 32 | N9305632 | 173 | N9305695 | 182 |
| N9304601 | 32 | N9305633 | 173 | N9305696 | 182 |
| N9304602 | 32 | N9305634 | 173 | N9305697 | 182 |
| N9304603 | 32 | N9305635 | 177 | N9305698 | 179 |
| N9304604 | 32 | N9305636 | 177 | N9306000 | 200 |
| N9304610 | 32 | N9305637 | 177 | N9306001 | 200 |

| Part No. | Page | Part No. | Page | Part No. | Page |
|----------|----------|----------|----------|----------|----------|
| N9306015 | 116, 117 | N9306107 | 232 | N9306288 | 170 |
| N9306017 | 163 | N9306108 | 232 | N9306291 | 240 |
| N9306019 | 163 | N9306109 | 232 | N9306292 | 240 |
| N9306020 | 163 | N9306110 | 232 | N9306293 | 240 |
| N9306021 | 163 | N9306111 | 232 | N9306300 | 162 |
| N9306022 | 166 | N9306112 | 232 | N9306301 | 162, 168 |
| N9306023 | 166 | N9306113 | 232 | N9306304 | 241 |
| N9306024 | 166 | N9306114 | 232 | N9306305 | 241 |
| N9306025 | 166 | N9306116 | 232 | N9306306 | 241 |
| N9306026 | 166 | N9306117 | 232 | N9306310 | 196 |
| N9306027 | 166 | N9306118 | 232 | N9306311 | 196 |
| N9306028 | 166 | N9306127 | 121 | N9306312 | 196 |
| N9306029 | 166 | N9306142 | 242, 243 | N9306313 | 196 |
| N9306030 | 166 | N9306200 | 116 | N9306314 | 196 |
| N9306031 | 166 | N9306201 | 115 | N9306315 | 196 |
| N9306032 | 166 | N9306203 | 116 | N9306316 | 196 |
| N9306033 | 166 | N9306205 | 116 | N9306317 | 196 |
| N9306034 | 166 | N9306206 | 116 | N9306318 | 196 |
| N9306035 | 166 | N9306207 | 115 | N9306319 | 196 |
| N9306036 | 166 | N9306208 | 115 | N9306320 | 196 |
| N9306037 | 166 | N9306210 | 171 | N9306321 | 196 |
| N9306038 | 166 | N9306211 | 171 | N9306322 | 196 |
| N9306039 | 166 | N9306212 | 171 | N9306323 | 196 |
| N9306040 | 166 | N9306213 | 171 | N9306324 | 196 |
| N9306041 | 166 | N9306214 | 171 | N9306325 | 196 |
| N9306042 | 166 | N9306216 | 118 | N9306326 | 196 |
| N9306044 | 163, 166 | N9306218 | 213 | N9306327 | 196 |
| N9306045 | 166 | N9306219 | 213 | N9306328 | 196 |
| N9306046 | 166 | N9306220 | 115 | N9306329 | 196 |
| N9306047 | 166 | N9306223 | 114 | N9306345 | 27 |
| N9306052 | 116 | N9306223 | 114, 115 | N9306346 | 27 |
| N9306053 | 115 | N9306224 | 119 | N9306350 | 240 |
| N9306057 | 115 | N9306225 | 81 | N9306351 | 240 |
| N9306063 | 242 | N9306228 | 116 | N9306352 | 240 |
| N9306064 | 234 | N9306229 | 116 | N9306360 | 116 |
| N9306065 | 234 | N9306231 | 115 | N9306361 | 116 |
| N9306068 | 163 | N9306232 | 211 | N9306362 | 116 |
| N9306072 | 163 | N9306233 | 211 | N9306363 | 116 |
| N9306073 | 163 | N9306234 | 211 | N9306364 | 116 |
| N9306074 | 242 | N9306235 | 211 | N9306365 | 116 |
| N9306075 | 118, 120 | N9306236 | 211 | N9306400 | 105 |
| N9306076 | 119, 120 | N9306237 | 211 | N9306401 | 106 |
| N9306077 | 119, 120 | N9306240 | 118 | N9306402 | 106 |
| N9306078 | 118 | N9306241 | 118 | N9306403 | 108 |
| N9306079 | 120 | N9306242 | 118 | N9306404 | 106 |
| N9306080 | 117 | N9306247 | 114 | N9306405 | 108 |
| N9306089 | 242 | N9306251 | 202 | N9306407 | 105 |
| N9306090 | 200 | N9306262 | 202 | N9306410 | 106 |
| N9306091 | 200 | N9306264 | 119 | N9306411 | 105 |
| N9306092 | 200 | N9306265 | 119, 120 | N9306413 | 105 |
| N9306093 | 200 | N9306266 | 119 | N9306414 | 106 |
| N9306093 | 224 | N9306267 | 119 | N9306416 | 105 |
| N9306094 | 200, 224 | N9306268 | 119 | N9306418 | 108 |
| N9306095 | 200, 224 | N9306269 | 119 | N9306419 | 105 |
| N9306096 | 200, 224 | N9306269 | 120 | N9306420 | 105 |
| N9306100 | 232 | N9306270 | 119 | N9306421 | 106 |
| N9306101 | 232 | N9306271 | 119 | N9306422 | 104 |
| N9306102 | 232 | N9306277 | 227 | N9306427 | 108 |
| N9306103 | 232 | N9306278 | 227 | N9306428 | 108 |
| N9306104 | 232 | N9306285 | 170 | N9306430 | 104 |
| N9306105 | 232 | N9306286 | 170 | N9306432 | 105 |
| N9306106 | 232 | N9306287 | 170 | N9306434 | 106 |

PART NUMBER INDEX

| Part No. | Page | Part No. | Page | Part No. | Page |
|----------|------|----------|------|----------|------|
| N9306436 | 105 | N9306539 | 105 | N9306601 | 109 |
| N9306438 | 104 | N9306540 | 105 | N9306602 | 109 |
| N9306440 | 108 | N9306541 | 105 | N9306603 | 109 |
| N9306441 | 108 | N9306542 | 105 | N9306604 | 109 |
| N9306443 | 105 | N9306543 | 105 | N9306605 | 109 |
| N9306444 | 106 | N9306544 | 105 | N9306606 | 109 |
| N9306447 | 105 | N9306545 | 105 | N9306607 | 109 |
| N9306448 | 104 | N9306546 | 105 | N9306608 | 109 |
| N9306455 | 104 | N9306547 | 105 | N9306609 | 109 |
| N9306457 | 104 | N9306548 | 105 | N9306610 | 109 |
| N9306462 | 104 | N9306549 | 105 | N9306611 | 109 |
| N9306466 | 106 | N9306550 | 105 | N9306612 | 109 |
| N9306470 | 105 | N9306551 | 105 | N9306613 | 109 |
| N9306471 | 104 | N9306552 | 105 | N9306614 | 109 |
| N9306475 | 104 | N9306553 | 104 | N9306615 | 109 |
| N9306476 | 104 | N9306554 | 104 | N9306616 | 109 |
| N9306478 | 104 | N9306555 | 104 | N9306617 | 109 |
| N9306479 | 104 | N9306556 | 104 | N9306618 | 109 |
| N9306481 | 105 | N9306557 | 108 | N9306619 | 109 |
| N9306482 | 104 | N9306558 | 108 | N9306620 | 109 |
| N9306490 | 106 | N9306559 | 108 | N9306621 | 109 |
| N9306491 | 104 | N9306560 | 108 | N9306622 | 109 |
| N9306494 | 105 | N9306561 | 108 | N9306623 | 109 |
| N9306500 | 108 | N9306562 | 108 | N9306624 | 109 |
| N9306501 | 108 | N9306563 | 104 | N9306625 | 109 |
| N9306502 | 108 | N9306564 | 104 | N9306626 | 109 |
| N9306503 | 108 | N9306565 | 104 | N9306627 | 109 |
| N9306504 | 108 | N9306566 | 104 | N9306628 | 109 |
| N9306505 | 108 | N9306567 | 104 | N9306629 | 109 |
| N9306506 | 108 | N9306568 | 104 | N9306630 | 109 |
| N9306507 | 108 | N9306569 | 106 | N9306631 | 109 |
| N9306508 | 108 | N9306570 | 106 | N9306632 | 109 |
| N9306509 | 108 | N9306571 | 106 | N9306633 | 104 |
| N9306510 | 108 | N9306572 | 106 | N9306634 | 104 |
| N9306511 | 105 | N9306573 | 106 | N9306635 | 108 |
| N9306512 | 105 | N9306574 | 106 | N9306636 | 108 |
| N9306513 | 105 | N9306575 | 105 | N9306637 | 108 |
| N9306514 | 105 | N9306576 | 105 | N9306638 | 108 |
| N9306515 | 105 | N9306577 | 105 | N9306639 | 108 |
| N9306516 | 105 | N9306578 | 105 | N9306640 | 104 |
| N9306517 | 105 | N9306579 | 105 | N9306641 | 106 |
| N9306518 | 106 | N9306580 | 105 | N9306642 | 104 |
| N9306519 | 104 | N9306581 | 104 | N9306643 | 106 |
| N9306520 | 104 | N9306582 | 104 | N9306644 | 106 |
| N9306521 | 104 | N9306583 | 104 | N9306645 | 106 |
| N9306522 | 104 | N9306584 | 106 | N9306646 | 108 |
| N9306523 | 104 | N9306585 | 106 | N9306647 | 108 |
| N9306524 | 106 | N9306586 | 106 | N9306648 | 108 |
| N9306525 | 106 | N9306587 | 104 | N9306649 | 105 |
| N9306526 | 106 | N9306588 | 104 | N9306650 | 107 |
| N9306527 | 106 | N9306589 | 104 | N9306651 | 107 |
| N9306528 | 106 | N9306590 | 104 | N9306652 | 107 |
| N9306529 | 106 | N9306591 | 104 | N9306653 | 107 |
| N9306530 | 106 | N9306592 | 104 | N9306655 | 107 |
| N9306531 | 106 | N9306593 | 104 | N9306656 | 107 |
| N9306532 | 106 | N9306594 | 109 | N9306657 | 107 |
| N9306533 | 106 | N9306595 | 109 | N9306658 | 107 |
| N9306534 | 106 | N9306596 | 109 | N9306659 | 107 |
| N9306535 | 106 | N9306597 | 109 | N9306660 | 107 |
| N9306536 | 105 | N9306598 | 109 | N9306661 | 107 |
| N9306537 | 105 | N9306599 | 109 | N9306662 | 107 |
| N9306538 | 105 | N9306600 | 109 | N9306663 | 107 |

| Part No. | Page | Part No. | Page | Part No. | Page |
|----------|------|----------|------|----------|----------|
| N9306664 | 107 | N9306821 | 231 | N9306941 | 111 |
| N9306665 | 107 | N9306822 | 231 | N9307000 | 227 |
| N9306666 | 107 | N9306823 | 231 | N9307001 | 227 |
| N9306667 | 107 | N9306824 | 231 | N9307002 | 227 |
| N9306668 | 107 | N9306825 | 231 | N9307003 | 227 |
| N9306669 | 107 | N9306826 | 231 | N9307004 | 227 |
| N9306670 | 107 | N9306827 | 231 | N9307005 | 225 |
| N9306671 | 107 | N9306828 | 230 | N9307005 | 227 |
| N9306672 | 107 | N9306829 | 230 | N9307006 | 227 |
| N9306673 | 107 | N9306830 | 230 | N9307007 | 227 |
| N9306674 | 107 | N9306831 | 230 | N9307008 | 227 |
| N9306675 | 107 | N9306832 | 230 | N9307009 | 227 |
| N9306676 | 107 | N9306833 | 230 | N9307010 | 227 |
| N9306677 | 107 | N9306834 | 230 | N9307011 | 227 |
| N9306678 | 107 | N9306835 | 230 | N9307012 | 227 |
| N9306679 | 107 | N9306836 | 230 | N9307013 | 227 |
| N9306680 | 107 | N9306837 | 230 | N9307017 | 115 |
| N9306681 | 107 | N9306838 | 230 | N9307018 | 115 |
| N9306682 | 107 | N9306839 | 230 | N9307021 | 116 |
| N9306683 | 107 | N9306840 | 231 | N9307023 | 116 |
| N9306684 | 107 | N9306841 | 231 | N9307026 | 227 |
| N9306685 | 107 | N9306842 | 231 | N9307029 | 243 |
| N9306686 | 107 | N9306843 | 231 | N9307037 | 227 |
| N9306687 | 107 | N9306844 | 231 | N9307038 | 227 |
| N9306688 | 107 | N9306845 | 231 | N9307050 | 227 |
| N9306689 | 107 | N9306846 | 231 | N9307051 | 227 |
| N9306690 | 107 | N9306847 | 231 | N9307052 | 227 |
| N9306691 | 107 | N9306848 | 231 | N9307053 | 227 |
| N9306692 | 107 | N9306849 | 231 | N9307054 | 227 |
| N9306693 | 107 | N9306850 | 231 | N9307055 | 227 |
| N9306694 | 107 | N9306851 | 231 | N9307056 | 227 |
| N9306695 | 107 | N9306852 | 231 | N9307057 | 227 |
| N9306696 | 107 | N9306853 | 231 | N9307058 | 227 |
| N9306697 | 107 | N9306854 | 231 | N9307059 | 227 |
| N9306698 | 107 | N9306855 | 231 | N9307060 | 227 |
| N9306699 | 107 | N9306856 | 231 | N9307061 | 227 |
| N9306700 | 107 | N9306857 | 231 | N9307062 | 227 |
| N9306713 | 105 | N9306900 | 111 | N9307063 | 227 |
| N9306755 | 89 | N9306901 | 111 | N9307064 | 227 |
| N9306757 | 89 | N9306902 | 111 | N9307065 | 227 |
| N9306758 | 89 | N9306908 | 111 | N9307066 | 227 |
| N9306800 | 230 | N9306909 | 111 | N9307075 | 238 |
| N9306801 | 230 | N9306910 | 111 | N9307076 | 238 |
| N9306802 | 230 | N9306911 | 111 | N9307077 | 238 |
| N9306803 | 230 | N9306912 | 111 | N9307078 | 238 |
| N9306804 | 230 | N9306913 | 111 | N9307079 | 238 |
| N9306805 | 230 | N9306914 | 111 | N9307080 | 238 |
| N9306806 | 230 | N9306920 | 111 | N9307081 | 238 |
| N9306807 | 230 | N9306921 | 111 | N9307082 | 238 |
| N9306808 | 230 | N9306922 | 111 | N9307083 | 238 |
| N9306809 | 230 | N9306923 | 111 | N9307085 | 243 |
| N9306810 | 230 | N9306924 | 111 | N9307086 | 243 |
| N9306811 | 230 | N9306925 | 111 | N9307093 | 235 |
| N9306812 | 230 | N9306926 | 111 | N9307094 | 235 |
| N9306813 | 230 | N9306927 | 111 | N9307095 | 235 |
| N9306814 | 231 | N9306933 | 111 | N9307096 | 235 |
| N9306815 | 231 | N9306935 | 111 | N9307097 | 234, 235 |
| N9306816 | 231 | N9306936 | 111 | N9307098 | 235 |
| N9306817 | 231 | N9306937 | 111 | N9307103 | 74 |
| N9306818 | 231 | N9306938 | 111 | N9307104 | 75 |
| N9306819 | 231 | N9306939 | 111 | N9307105 | 75 |
| N9306820 | 231 | N9306940 | 111 | N9307106 | 75 |

PART NUMBER INDEX

| Part No. | Page | Part No. | Page | Part No. | Page |
|----------|------|----------|------|----------|------|
| N9307107 | 75 | N9308017 | 93 | N9308205 | 82 |
| N9307108 | 76 | N9308018 | 94 | N9308206 | 82 |
| N9307109 | 76 | N9308019 | 92 | N9308207 | 82 |
| N9307110 | 76 | N9308020 | 94 | N9308208 | 82 |
| N9307111 | 74 | N9308021 | 94 | N9308209 | 82 |
| N9307112 | 74 | N9308022 | 94 | N9308210 | 82 |
| N9307113 | 71 | N9308023 | 94 | N9308211 | 82 |
| N9307114 | 71 | N9308024 | 93 | N9308212 | 82 |
| N9307115 | 71 | N9308025 | 93 | N9308213 | 82 |
| N9307116 | 71 | N9308027 | 93 | N9308214 | 82 |
| N9307117 | 70 | N9308029 | 94 | N9308215 | 82 |
| N9307118 | 74 | N9308030 | 93 | N9308216 | 82 |
| N9307119 | 74 | N9308031 | 93 | N9308217 | 82 |
| N9307504 | 89 | N9308032 | 93 | N9308218 | 82 |
| N9307509 | 89 | N9308033 | 93 | N9308219 | 82 |
| N9307511 | 89 | N9308034 | 93 | N9308220 | 82 |
| N9307512 | 89 | N9308035 | 109 | N9308221 | 82 |
| N9307515 | 89 | N9308036 | 94 | N9308222 | 82 |
| N9307519 | 89 | N9308037 | 93 | N9308223 | 82 |
| N9307521 | 89 | N9308041 | 94 | N9308224 | 82 |
| N9307522 | 89 | N9308042 | 94 | N9308225 | 82 |
| N9307522 | 89 | N9308044 | 94 | N9308226 | 82 |
| N9307523 | 89 | N9308045 | 94 | N9308227 | 82 |
| N9307738 | 74 | N9308048 | 93 | N9308228 | 82 |
| N9307740 | 86 | N9308049 | 93 | N9308229 | 82 |
| N9307741 | 72 | N9308050 | 93 | N9308230 | 82 |
| N9307760 | 89 | N9308056 | 93 | N9308231 | 82 |
| N9307800 | 162 | N9308058 | 93 | N9308232 | 82 |
| N9307801 | 115 | N9308059 | 93 | N9308233 | 82 |
| N9307802 | 115 | N9308060 | 93 | N9308234 | 82 |
| N9307805 | 74 | N9308063 | 109 | N9308235 | 82 |
| N9307806 | 74 | N9308065 | 94 | N9308236 | 82 |
| N9307807 | 74 | N9308066 | 93 | N9308237 | 82 |
| N9307808 | 74 | N9308067 | 94 | N9308238 | 82 |
| N9307809 | 76 | N9308068 | 94 | N9308239 | 83 |
| N9307810 | 76 | N9308069 | 94 | N9308241 | 83 |
| N9307820 | 168 | N9308070 | 94 | N9308242 | 83 |
| N9307822 | 168 | N9308073 | 94 | N9308243 | 83 |
| N9307823 | 116 | N9308150 | 89 | N9308245 | 83 |
| N9307830 | 28 | N9308160 | 84 | N9308247 | 83 |
| N9307831 | 28 | N9308161 | 84 | N9308248 | 83 |
| N9307832 | 28 | N9308162 | 84 | N9308249 | 83 |
| N9307833 | 28 | N9308163 | 84 | N9308251 | 83 |
| N9307834 | 31 | N9308164 | 84 | N9308252 | 83 |
| N9307835 | 31 | N9308165 | 84 | N9308255 | 82 |
| N9308000 | 94 | N9308166 | 84 | N9308258 | 83 |
| N9308001 | 94 | N9308167 | 84 | N9308259 | 83 |
| N9308002 | 93 | N9308168 | 84 | N9308262 | 84 |
| N9308003 | 93 | N9308169 | 84 | N9308263 | 84 |
| N9308004 | 92 | N9308170 | 84 | N9308264 | 84 |
| N9308005 | 92 | N9308173 | 85 | N9308265 | 84 |
| N9308006 | 92 | N9308174 | 85 | N9308266 | 84 |
| N9308007 | 92 | N9308176 | 85 | N9308267 | 84 |
| N9308008 | 93 | N9308177 | 85 | N9308268 | 84 |
| N9308009 | 94 | N9308178 | 85 | N9308269 | 84 |
| N9308010 | 92 | N9308181 | 85 | N9308270 | 84 |
| N9308011 | 93 | N9308182 | 85 | N9308271 | 84 |
| N9308012 | 92 | N9308200 | 82 | N9308272 | 84 |
| N9308013 | 93 | N9308201 | 82 | N9308273 | 84 |
| N9308014 | 92 | N9308202 | 82 | N9308274 | 84 |
| N9308015 | 93 | N9308203 | 82 | N9308278 | 85 |
| N9308016 | 93 | N9308204 | 82 | N9308279 | 85 |

| Part No. | Page | Part No. | Page | Part No. | Page |
|----------|---------|----------|---------|----------|------|
| N9308280 | 85 | N9308352 | 86, 262 | N9308427 | 125 |
| N9308281 | 85 | N9308354 | 86, 262 | N9308428 | 125 |
| N9308282 | 85 | N9308355 | 83 | N9308429 | 125 |
| N9308283 | 85 | N9308356 | 83 | N9308430 | 125 |
| N9308284 | 85 | N9308357 | 83 | N9308431 | 125 |
| N9308285 | 85 | N9308358 | 83 | N9308432 | 125 |
| N9308286 | 85 | N9308359 | 83 | N9308433 | 125 |
| N9308287 | 85 | N9308360 | 83 | N9308434 | 125 |
| N9308288 | 85 | N9308361 | 83 | N9308435 | 125 |
| N9308289 | 85 | N9308362 | 83 | N9308450 | 125 |
| N9308290 | 86 | N9308363 | 83 | N9308451 | 125 |
| N9308291 | 86 | N9308364 | 83 | N9308452 | 125 |
| N9308292 | 86 | N9308365 | 83 | N9308453 | 125 |
| N9308293 | 86 | N9308366 | 83 | N9308454 | 125 |
| N9308294 | 86 | N9308367 | 83 | N9308455 | 125 |
| N9308295 | 86 | N9308368 | 83 | N9308456 | 125 |
| N9308296 | 86 | N9308369 | 83 | N9308457 | 125 |
| N9308297 | 84 | N9308370 | 83 | N9308458 | 125 |
| N9308300 | 83 | N9308371 | 83 | N9308459 | 125 |
| N9308301 | 83 | N9308372 | 83 | N9308460 | 125 |
| N9308302 | 83 | N9308373 | 83 | N9308461 | 125 |
| N9308303 | 83 | N9308374 | 83 | N9308462 | 125 |
| N9308304 | 83 | N9308375 | 86 | N9308463 | 125 |
| N9308305 | 83 | N9308376 | 86, 262 | N9308464 | 125 |
| N9308306 | 83 | N9308377 | 86 | N9308465 | 125 |
| N9308307 | 83 | N9308378 | 84 | N9308466 | 125 |
| N9308308 | 83 | N9308380 | 86, 262 | N9308467 | 125 |
| N9308309 | 83 | N9308381 | 94 | N9308468 | 125 |
| N9308310 | 83 | N9308382 | 94 | N9308469 | 125 |
| N9308311 | 83 | N9308390 | 85 | N9308470 | 125 |
| N9308312 | 83 | N9308391 | 85 | N9308471 | 125 |
| N9308313 | 83 | N9308392 | 85 | N9308472 | 125 |
| N9308314 | 86 | N9308393 | 85 | N9308473 | 125 |
| N9308315 | 83 | N9308394 | 85 | N9308474 | 125 |
| N9308316 | 83 | N9308395 | 85 | N9308475 | 125 |
| N9308317 | 83 | N9308400 | 125 | N9308476 | 125 |
| N9308318 | 83 | N9308401 | 125 | N9308477 | 125 |
| N9308319 | 83 | N9308402 | 125 | N9308478 | 125 |
| N9308320 | 83 | N9308403 | 125 | N9308479 | 125 |
| N9308321 | 83 | N9308404 | 125 | N9308480 | 125 |
| N9308322 | 82 | N9308405 | 125 | N9308481 | 125 |
| N9308323 | 82 | N9308406 | 125 | N9308482 | 125 |
| N9308324 | 83 | N9308407 | 125 | N9308483 | 125 |
| N9308325 | 83 | N9308408 | 125 | N9308484 | 125 |
| N9308326 | 83 | N9308409 | 125 | N9308485 | 125 |
| N9308327 | 83 | N9308410 | 125 | N9308486 | 125 |
| N9308328 | 83 | N9308411 | 125 | N9308487 | 125 |
| N9308329 | 83 | N9308412 | 125 | N9308488 | 125 |
| N9308330 | 83 | N9308413 | 125 | N9308489 | 125 |
| N9308331 | 109 | N9308414 | 125 | N9308490 | 125 |
| N9308332 | 109 | N9308415 | 125 | N9308491 | 125 |
| N9308333 | 83 | N9308416 | 125 | N9308492 | 125 |
| N9308334 | 83 | N9308417 | 125 | N9308493 | 125 |
| N9308340 | 93 | N9308418 | 125 | N9308494 | 125 |
| N9308341 | 85 | N9308419 | 125 | N9308495 | 125 |
| N9308342 | 85 | N9308420 | 125 | N9308496 | 125 |
| N9308343 | 85 | N9308421 | 125 | N9308497 | 125 |
| N9308344 | 85 | N9308422 | 125 | N9308498 | 125 |
| N9308345 | 85 | N9308423 | 125 | N9308499 | 125 |
| N9308346 | 85 | N9308424 | 125 | N9308500 | 125 |
| N9308350 | 86, 262 | N9308425 | 125 | N9308501 | 125 |
| N9308351 | 86, 262 | N9308426 | 125 | N9308502 | 125 |

PART NUMBER INDEX

| Part No. | Page | Part No. | Page | Part No. | Page |
|----------|--------|----------|------|----------|------|
| N9308503 | 125 | N9308702 | 94 | N9315067 | 189 |
| N9308504 | 125 | N9308703 | 94 | N9315068 | 189 |
| N9308505 | 125 | N9308704 | 93 | N9315069 | 189 |
| N9308506 | 125 | N9308705 | 93 | N9315070 | 189 |
| N9308507 | 125 | N9308706 | 93 | N9315071 | 190 |
| N9308508 | 125 | N9308707 | 94 | N9315072 | 190 |
| N9308509 | 125 | N9308708 | 93 | N9315073 | 190 |
| N9308510 | 125 | N9308709 | 92 | N9315074 | 190 |
| N9308511 | 125 | N9308710 | 92 | N9315075 | 190 |
| N9308512 | 125 | N9308711 | 93 | N9315076 | 190 |
| N9308513 | 125 | N9308712 | 93 | N9315499 | 176 |
| N9308514 | 125 | N9308713 | 93 | N9316001 | 176 |
| N9308515 | 125 | N9308714 | 85 | N9316002 | 176 |
| N9308516 | 125 | N9308715 | 85 | N9316003 | 176 |
| N9308517 | 125 | N9308716 | 85 | N9316004 | 176 |
| N9308518 | 125 | N9308717 | 85 | N9316005 | 176 |
| N9308519 | 125 | N9308718 | 85 | N9316006 | 176 |
| N9308520 | 125 | N9308719 | 85 | N9316007 | 176 |
| N9308521 | 125 | N9308720 | 85 | N9316008 | 176 |
| N9308522 | 125 | N9308721 | 85 | N9316009 | 176 |
| N9308523 | 125 | N9308722 | 85 | N9316010 | 176 |
| N9308524 | 125 | N9308723 | 85 | N9316011 | 176 |
| N9308525 | 125 | N9308724 | 85 | N9316012 | 176 |
| N9308526 | 125 | N9308725 | 86 | N9316013 | 176 |
| N9308527 | 125 | N9308726 | 85 | N9316014 | 176 |
| N9308528 | 125 | N9308900 | 262 | N9316015 | 194 |
| N9308529 | 125 | N9308901 | 262 | N9316016 | 176 |
| N9308530 | 125 | N9308904 | 262 | N9316017 | 176 |
| N9308531 | 125 | N9309004 | 33 | N9316018 | 176 |
| N9308532 | 125 | N9309006 | 33 | N9316019 | 176 |
| N9308533 | 125 | N9309007 | 33 | N9316020 | 176 |
| N9308534 | 125 | N9309008 | 33 | N9316021 | 176 |
| N9308535 | 159 | N9309009 | 33 | N9316022 | 176 |
| N9308540 | 86 | N9309010 | 33 | N9316023 | 176 |
| N9308541 | 71 | N9309011 | 33 | N9316024 | 176 |
| N9308542 | 71 | N9309012 | 33 | N9316025 | 176 |
| N9308543 | 71 | N9309013 | 33 | N9316026 | 176 |
| N9308552 | 83 | N9309017 | 33 | N9316027 | 176 |
| N9308554 | 85 | N9309019 | 33 | N9316028 | 176 |
| N9308555 | 85 | N9309021 | 33 | N9316029 | 176 |
| N9308571 | 81 | N9309024 | 33 | N9316030 | 176 |
| N9308573 | 169 | N9309025 | 33 | N9316031 | 176 |
| N9308574 | 169 | N9309026 | 33 | N9316032 | 176 |
| N9308575 | 169 | N9309027 | 33 | N9316034 | 176 |
| N9308576 | 169 | N9309028 | 33 | N9316035 | 176 |
| N9308577 | 234 | N9309029 | 33 | N9316036 | 176 |
| N9308578 | 234 | N9309030 | 33 | N9316037 | 176 |
| N9308579 | 234 | N9309031 | 33 | N9316038 | 176 |
| N9308580 | 234 | N9309032 | 33 | N9316039 | 176 |
| N9308581 | 235 | N9309033 | 33 | N9316040 | 176 |
| N9308582 | 235 | N9309034 | 33 | N9316041 | 176 |
| N9308583 | 235 | N9309035 | 33 | N9316042 | 176 |
| N9308584 | 235 | N9309036 | 33 | N9316043 | 176 |
| N9308585 | 235 | N9309066 | 33 | N9316044 | 176 |
| N9308587 | 169 | N9309103 | 33 | N9316045 | 176 |
| N9308588 | 169 | N9309108 | 33 | N9316046 | 176 |
| N9308589 | 169 | N9309109 | 33 | N9316047 | 176 |
| N9308590 | 169 | N9309110 | 33 | N9316048 | 176 |
| N9308591 | 74, 80 | N9309130 | 227 | N9316049 | 176 |
| N9308592 | 74, 80 | N9309160 | 226 | N9316050 | 176 |
| N9308700 | 94 | N9309161 | 226 | N9316051 | 176 |
| N9308701 | 94 | N9311570 | 194 | N9316052 | 176 |

| Part No. | Page | Part No. | Page | Part No. | Page |
|----------|----------|----------|------|----------|------|
| N9316053 | 176 | N9316123 | 180 | N9316203 | 189 |
| N9316054 | 176 | N9316124 | 180 | N9316204 | 189 |
| N9316056 | 176 | N9316125 | 180 | N9316205 | 189 |
| N9316057 | 176 | N9316126 | 180 | N9316206 | 189 |
| N9316058 | 176 | N9316127 | 180 | N9316207 | 189 |
| N9316061 | 176 | N9316128 | 180 | N9316208 | 189 |
| N9316062 | 176 | N9316129 | 180 | N9316209 | 189 |
| N9316063 | 176 | N9316130 | 180 | N9316210 | 185 |
| N9316064 | 176 | N9316131 | 180 | N9316212 | 185 |
| N9316065 | 194 | N9316132 | 180 | N9316213 | 185 |
| N9316066 | 178 | N9316133 | 180 | N9316214 | 185 |
| N9316067 | 178 | N9316134 | 180 | N9316215 | 185 |
| N9316068 | 178 | N9316135 | 180 | N9316216 | 185 |
| N9316069 | 178 | N9316136 | 180 | N9316217 | 185 |
| N9316071 | 178 | N9316137 | 180 | N9316218 | 185 |
| N9316072 | 178 | N9316138 | 180 | N9316219 | 185 |
| N9316073 | 178 | N9316139 | 180 | N9316220 | 185 |
| N9316074 | 178 | N9316140 | 180 | N9316221 | 185 |
| N9316075 | 178 | N9316141 | 180 | N9316222 | 185 |
| N9316076 | 117, 178 | N9316142 | 180 | N9316223 | 185 |
| N9316077 | 178 | N9316143 | 180 | N9316224 | 185 |
| N9316078 | 178 | N9316144 | 182 | N9316225 | 185 |
| N9316079 | 178 | N9316145 | 182 | N9316226 | 185 |
| N9316080 | 178 | N9316146 | 182 | N9316227 | 185 |
| N9316081 | 178 | N9316147 | 182 | N9316228 | 186 |
| N9316082 | 178 | N9316148 | 182 | N9316229 | 186 |
| N9316083 | 178 | N9316149 | 182 | N9316230 | 186 |
| N9316085 | 178 | N9316150 | 182 | N9316231 | 186 |
| N9316086 | 178 | N9316151 | 182 | N9316232 | 186 |
| N9316087 | 178 | N9316152 | 182 | N9316234 | 186 |
| N9316089 | 178 | N9316153 | 182 | N9316235 | 186 |
| N9316090 | 178 | N9316172 | 184 | N9316236 | 186 |
| N9316091 | 178 | N9316173 | 184 | N9316237 | 186 |
| N9316092 | 178 | N9316174 | 184 | N9316238 | 186 |
| N9316093 | 178 | N9316175 | 184 | N9316239 | 186 |
| N9316094 | 178 | N9316176 | 184 | N9316240 | 186 |
| N9316095 | 178 | N9316177 | 184 | N9316242 | 186 |
| N9316096 | 178 | N9316178 | 184 | N9316243 | 186 |
| N9316097 | 178 | N9316179 | 184 | N9316244 | 186 |
| N9316098 | 178 | N9316180 | 184 | N9316245 | 186 |
| N9316099 | 178 | N9316182 | 184 | N9316246 | 186 |
| N9316100 | 178 | N9316183 | 184 | N9316247 | 186 |
| N9316101 | 178 | N9316184 | 184 | N9316248 | 186 |
| N9316102 | 178 | N9316185 | 184 | N9316249 | 186 |
| N9316103 | 178 | N9316186 | 184 | N9316250 | 186 |
| N9316104 | 178 | N9316187 | 184 | N9316251 | 186 |
| N9316105 | 178 | N9316188 | 193 | N9316252 | 186 |
| N9316108 | 178 | N9316189 | 193 | N9316253 | 186 |
| N9316109 | 178 | N9316189 | 193 | N9316254 | 186 |
| N9316110 | 178 | N9316190 | 193 | N9316255 | 186 |
| N9316111 | 178 | N9316191 | 193 | N9316256 | 186 |
| N9316112 | 178 | N9316192 | 193 | N9316257 | 186 |
| N9316113 | 180 | N9316193 | 193 | N9316258 | 186 |
| N9316114 | 180 | N9316194 | 193 | N9316259 | 186 |
| N9316115 | 180 | N9316195 | 193 | N9316261 | 193 |
| N9316116 | 180 | N9316196 | 193 | N9316262 | 193 |
| N9316117 | 180 | N9316197 | 193 | N9316263 | 180 |
| N9316118 | 180 | N9316198 | 193 | N9316264 | 180 |
| N9316119 | 180 | N9316199 | 193 | N9316265 | 180 |
| N9316120 | 180 | N9316200 | 189 | N9316266 | 180 |
| N9316121 | 180 | N9316201 | 189 | N9316267 | 180 |
| N9316122 | 180 | N9316202 | 189 | N9316268 | 177 |

PART NUMBER INDEX

| Part No. | Page | Part No. | Page | Part No. | Page |
|----------|------|----------|----------|----------|------|
| N9316269 | 177 | N9316404 | 187 | N9316551 | 188 |
| N9316270 | 177 | N9316405 | 187 | N9316552 | 188 |
| N9316271 | 177 | N9316406 | 187 | N9316553 | 188 |
| N9316272 | 178 | N9316407 | 187 | N9316554 | 188 |
| N9316273 | 178 | N9316408 | 187 | N9316555 | 188 |
| N9316275 | 178 | N9316409 | 187 | N9316556 | 188 |
| N9316276 | 179 | N9316410 | 187 | N9316557 | 188 |
| N9316277 | 179 | N9316411 | 187 | N9316558 | 188 |
| N9316279 | 179 | N9316412 | 187 | N9316559 | 188 |
| N9316280 | 179 | N9316413 | 187 | N9316560 | 188 |
| N9316282 | 179 | N9316416 | 187 | N9316561 | 188 |
| N9316283 | 179 | N9316417 | 187 | N9316563 | 188 |
| N9316284 | 179 | N9316418 | 187 | N9316564 | 188 |
| N9316286 | 179 | N9316419 | 187 | N9316565 | 188 |
| N9316287 | 179 | N9316420 | 187 | N9316566 | 188 |
| N9316289 | 179 | N9316421 | 187 | N9316567 | 188 |
| N9316290 | 179 | N9316422 | 187 | N9316568 | 188 |
| N9316291 | 179 | N9316423 | 187 | N9316569 | 188 |
| N9316293 | 179 | N9316425 | 187 | N9316570 | 188 |
| N9316294 | 179 | N9316426 | 187 | N9316571 | 188 |
| N9316295 | 179 | N9316427 | 187 | N9316572 | 194 |
| N9316297 | 179 | N9316428 | 187 | N9316575 | 190 |
| N9316298 | 179 | N9316429 | 187 | N9316580 | 176 |
| N9316299 | 179 | N9316478 | 187 | N9316596 | 176 |
| N9316300 | 179 | N9316480 | 191 | N9316607 | 228 |
| N9316301 | 179 | N9316481 | 191 | N9316608 | 228 |
| N9316302 | 179 | N9316483 | 191 | N9316616 | 183 |
| N9316303 | 179 | N9316484 | 191 | N9316617 | 183 |
| N9316304 | 195 | N9316485 | 191 | N9316618 | 183 |
| N9316305 | 195 | N9316487 | 191 | N9316619 | 183 |
| N9316319 | 193 | N9316488 | 191 | N9316620 | 183 |
| N9316345 | 193 | N9316489 | 191 | N9316621 | 183 |
| N9316346 | 193 | N9316490 | 191 | N9316622 | 183 |
| N9316347 | 193 | N9316491 | 191 | N9316623 | 183 |
| N9316348 | 193 | N9316492 | 191 | N9316624 | 183 |
| N9316349 | 193 | N9316493 | 191 | N9316625 | 183 |
| N9316350 | 193 | N9316494 | 191 | N9316626 | 183 |
| N9316351 | 194 | N9316495 | 191 | N9316627 | 183 |
| N9316352 | 194 | N9316496 | 191 | N9316628 | 183 |
| N9316353 | 194 | N9316497 | 191 | N9316629 | 183 |
| N9316354 | 194 | N9316498 | 193 | N9316630 | 183 |
| N9316355 | 194 | N9316506 | 194 | N9316631 | 183 |
| N9316356 | 194 | N9316507 | 194 | N9316632 | 183 |
| N9316357 | 194 | N9316508 | 194 | N9316633 | 183 |
| N9316358 | 194 | N9316520 | 194 | N9316634 | 183 |
| N9316359 | 195 | N9316521 | 194 | N9316635 | 183 |
| N9316360 | 195 | N9316534 | 181 | N9316636 | 183 |
| N9316361 | 195 | N9316535 | 181 | N9316637 | 183 |
| N9316374 | 178 | N9316536 | 181 | N9316638 | 183 |
| N9316386 | 194 | N9316537 | 181 | N9316639 | 183 |
| N9316387 | 194 | N9316538 | 181 | N9316640 | 183 |
| N9316388 | 192 | N9316539 | 181 | N9316641 | 183 |
| N9316389 | 192 | N9316540 | 181 | N9316642 | 183 |
| N9316390 | 192 | N9316541 | 181 | N9316643 | 183 |
| N9316391 | 192 | N9316542 | 181 | N9316644 | 183 |
| N9316392 | 192 | N9316544 | 195 | N9316645 | 183 |
| N9316393 | 192 | N9316545 | 193, 195 | N9316646 | 183 |
| N9316399 | 187 | N9316546 | 195 | N9316647 | 183 |
| N9316400 | 187 | N9316547 | 188 | N9316648 | 183 |
| N9316401 | 187 | N9316548 | 188 | N9316649 | 183 |
| N9316402 | 187 | N9316549 | 188 | N9316650 | 191 |
| N9316403 | 187 | N9316550 | 188 | N9316651 | 191 |

| Part No. | Page | Part No. | Page | Part No. | Page |
|----------|------|-----------|----------------|-------------------|------------|
| N9316652 | 191 | NR004030 | 198 | WE014081 | 52 |
| N9316653 | 191 | NR004031 | 198 | WE014777 | 56 |
| N9316654 | 191 | NR004038 | 198 | WE015554 | 55 |
| N9316655 | 191 | NR004040 | 198 | WE016558 | 87 |
| N9316656 | 191 | NR004041 | 198 | WE017142 | 57 |
| N9316657 | 191 | NR004043 | 198 | WE018034 | 56, 58 |
| N9316658 | 191 | NR004044 | 198 | WE021137 | 57, 58 |
| N9316659 | 191 | NR004045 | 198 | WE021140 | 57, 58 |
| N9316661 | 192 | NR004046 | 198 | WE021816 | 55, 58, 59 |
| N9316662 | 192 | NR004083 | 198 | WE023948 | 54, 58, 59 |
| N9316663 | 192 | NR004086 | 198 | WE023951 | 54 |
| N9316664 | 192 | NR004087 | 198 | WE024371 | 48 |
| N9316665 | 192 | NR004229 | 198 | WE024372 | 48 |
| N9316666 | 192 | NX598006 | 160, 161, 168 | WE024375 | 48, 59 |
| N9316667 | 192 | PELA 9011 | 269 | WE025221 | 51, 58 |
| N9316668 | 192 | PELA 9013 | 269 | WE027005 | 54 |
| N9316669 | 192 | PELA 9018 | 269 | WE027030 | 54 |
| N9316670 | 192 | PELA 9019 | 269 | WE027484 | 57 |
| N9316671 | 192 | PELA 9058 | 269 | WE027802 | 57, 58 |
| N9316672 | 192 | PELA1003 | 282 | WE027803 | 57, 58 |
| N9316673 | 178 | PELA1005 | 282 | WE029011 | 56 |
| N9316674 | 178 | PELA1006 | 282 | ZECVSTDDADMWD | 126 |
| N9316675 | 178 | PELA1008 | 282 | ZECVSTDVWD | 126 |
| N9316676 | 178 | PELA1013 | 282 | ZECVSTDWPDADMWD | 126 |
| N9316677 | 178 | PELA1014 | 282 | ZECVSTDWPVWD | 126 |
| N9316678 | 178 | PELA1015 | 282 | ZG196985000 | 122 |
| N9316679 | 178 | PELA9038 | 280 | ZG2421A | 122 |
| N9316680 | 178 | PELA9039 | 280 | ZULECVSTDDADMWD | 126 |
| N9316681 | 178 | PELA9040 | 279, 280 | ZULECVSTDVWD | 126 |
| N9316682 | 178 | PELA9057 | 280 | ZULECVSTDWPDADMWD | 126 |
| N9316684 | 178 | W1007468 | 55 | ZULECVSTDWPVWD | 126 |
| N9316685 | 176 | W1008384 | 55 | | |
| N9316686 | 176 | W1008572 | 55 | | |
| N9316691 | 176 | W1008573 | 55 | | |
| N9316692 | 176 | W1010620 | 56 | | |
| N9318482 | 191 | W1012406 | 54, 55, 58, 59 | | |
| N9326141 | 186 | W1012406 | 54 | | |
| N9331028 | 245 | W1012408 | 55 | | |
| N9331030 | 245 | W1012409 | 55 | | |
| N9331031 | 245 | W1013195 | 56 | | |
| N9331032 | 245 | W1013266 | 54 | | |
| N9331033 | 245 | W1013361 | 56 | | |
| N9331036 | 245 | W1013545 | 54, 55 | | |
| N9331037 | 245 | W1017871 | 56 | | |
| N9331038 | 245 | W1020668 | 55 | | |
| N9331041 | 244 | W1020672 | 55 | | |
| N9331042 | 244 | W1020996 | 58 | | |
| N9331043 | 244 | W1026356 | 57, 59 | | |
| N9331044 | 245 | W1026907 | 57, 59 | | |
| N9331045 | 245 | W1033612 | 57, 59 | | |
| N9331046 | 245 | W1033614 | 57, 59 | | |
| N9331047 | 244 | W1033995 | 57, 59 | | |
| N9331048 | 244 | W1034694 | 57 | | |
| N9331060 | 245 | W1036712 | 59, 91 | | |
| N9331061 | 245 | W1036713 | 59, 91 | | |
| N9331062 | 245 | W1037267 | 59 | | |
| N9331063 | 245 | W1037485 | 55 | | |
| N9331064 | 245 | W1040148 | 57, 59 | | |
| N9334010 | 152 | W5005586 | 59 | | |
| N9336181 | 184 | WE012411 | 55 | | |
| NR002500 | 198 | WE013060 | 52, 54 | | |
| NR002503 | 198 | We014034 | 58 | | |

| | |
|---|--------------|
| Atomic Spectroscopy - Instrument Overview | 12-13 |
| AAAnalyst 200/400 Atomic Absorption Spectrometers | 12 |
| NexION 350 ICP-MS Spectrometers | 13 |
| Optima 8x00 ICP-OES Spectrometers..... | 13 |
| PinAAcle 900 Atomic Absorption Spectrometers | 12 |
| Autosampler Cups and Supplies | 26 |
| Autosampler Cups..... | 26 |
| Autosampler Trays..... | 26 |
| Pliers | 26 |
| Reagent Containers..... | 26 |
| Sampling Capillaries | 26 |
| Burner System Components..... | 20-21 |
| Burner Heads | 20 |
| Burner System Components | 21 |
| Compressors | 27 |
| Graphite Furnace Tubes and Supplies | 28-32 |
| HGA Graphite Tubes and Supplies | 30-32 |
| Contact Cylinders | 31 |
| Graphite Tubes | 30-32 |
| Matrix Modifiers | 31 |
| THGA Graphite Tubes and Supplies | 28-29 |
| Accessories and Spare Parts | 29 |
| Contact Cylinders | 29 |
| Graphite Tubes | 28-29 |
| Instrument Mirror | 29 |
| Matrix Modifiers | 29 |
| Lamps..... | 14-19 |
| 1.5" Atomax Hollow Cathode Lamps | 18-19 |
| 2" Lumina Hollow Cathode Lamps..... | 14-15 |
| Lumina Multi-Element Hollow Cathode Lamps..... | 15 |
| Lumina Single-Element Hollow Cathode Lamps..... | 14-15 |
| Electrodeless Discharge Lamps..... | 16-17 |
| EDL Driver Assemblies..... | 17 |
| EDL Driver Components..... | 17 |
| Electrodeless Discharge Lamps | 16 |
| Mercury Analyzer Supplies | 33 |
| Nebulizers, Assemblies and Spares | 22-25 |
| Nebulizer Accessories | 24-25 |
| Nebulizers | 22-23 |

| | |
|---|--|
| Autosampler Supplies..... 63-65 | Sample Preparation Blocks..... 92-94 |
| Accessories.....64 | Sample Preparation Blocks and Controllers92 |
| Autosampler Probe Assemblies.....63 | Automatic Shut-Off System94 |
| Cetac.....63 | Digi FILTERS93 |
| ESI.....63 | SPB Hoods.....94 |
| PerkinElmer63 | Start Up Kits93 |
| Used Oil Autosampler Probe.....63 | Temperature Probes94 |
|63 | Tubes, Caps & Watch Glasses.....93 |
| Autosampler Tubes 65 | |
| Cooling Systems..... 87 | Standards..... 68-86 |
| Chiller Coolant Mix87 | Inorganic Aqueous Standards 68-81 |
| Chillers/Recirculating Water Cooling Systems.....87 | AA Test Mix73 |
| Coolant Fluid.....87 | Contract Required Detection Limits (CRDL)80 |
| Heat Exchanger System87 | Environmental Method Sets 74-76 |
| Flow Injection System..... 66-67 | GFAAS Mixed Standard.....73 |
| Adapters and Connectors.....66 | Initial Calibration Verification Standards79 |
| Mixing/Separation Assembly.....67 | Instrument Calibration Standards.....78 |
| Flow Injection Furnace Supplies.....67 | Instrument Calibration Standards for CLP.....79 |
| Gas/Liquid Separator.....67 | Instrument Check Standards79 |
| Mixing Block.....67 | Instrument Setup Solutions78 |
| Sample Loops67 | Interference Check Standards79 |
| Tool, Screw Connectors67 | Internal Standard Solutions80 |
| Tubing.....67 | Isotope Standard81 |
| Internal Standard Kits..... 61 | Matrix Blanks.....81 |
| Internal Standard Kits61 | Matrix Modifiers for Graphite Furnace AA.....73 |
| HF-Resistant Internal Standard Kit.....61 | Mixed Calibration Standards72 |
| Non HF-Resistant Internal Standard Kit.....61 | Multi-Element Standards..... 71-72 |
| Laboratory Products 90-91 | Performance Verification Standards.....80 |
| Blower and Vent Assembly90 | Quality Control Standards.....72 |
| Dryers, Filters, and Replacement Parts.....91 | Reagents73 |
| Flashback Arrestor.....90 | Single-Element Standards 68-70 |
| Hose Assemblies.....90 | SmartTune Standards.....78 |
| Instrument Filters.....91 | Spike Sample Standards.....72 |
| Polyscience Replacement Air Filters.....91 | Toxicity Characteristic Leachate Procedure |
| Regulators.....90 | (TCLP) Standard77 |
| Microwave Sample Preparation..... 95-97 | Universal Data Acquisition Standards Kit.....81 |
| Titan MPS Systems95 | USP and ICH Standards.....77 |
| Titan MPS System Accessories 96-97 | Wash Standards.....81 |
| Titan MPS Consumables 96-97 | Water Pollutant Standards76 |
| Power Conditioners and UPS Systems 89 | Wear Metal Metallo-Organic Standards 82-86 |
| Power Conditioners.....89 | Biodiesel Standards.....85 |
| Uninterruptable Power Supply Systems.....89 | Fuel Dilution Oils.....84 |
| Pump Tubing 60-62 | Internal Standards.....83 |
| Three-Stop Peristaltic Pump Tubing.....62 | Karl Fischer Standards.....85 |
| Two-Stop Peristaltic Pump Tubing60, 62 | Matrix Oils and Solvents.....84 |
| Noise Enclosures 88 | Metal Additive Standards.....83 |
| | OilExpress Standards.....86 |
| | Proficiency Testing Standards86 |
| | Single-Element Standards82 |
| | Soot Content Standards.....85 |
| | V-21 Wear Metal Standards83 |
| | V-23 Wear Metal Standards83 |
| | Viscosity Reference Standards86 |
| | V-Solv84 |
| | Trays and Racks 64 |
| | Cetac Autosampler Supplies.....64 |
| | Racks.....64 |
| | ESI Autosampler Supplies64 |
| | Racks and Rack Covers64 |
| | PerkinElmer Sample Trays64 |
| | Trays and Supplies64 |

Crimping Tools and Vial Accessories..... 121

QuEChERS Dispersive SPE..... 110-111

Solid Phase Extraction (SPE)..... 101-109

| | |
|--|---------|
| Solid Phase Extraction (SPE) Application Packs | 109 |
| Solid Phase Extraction (SPE) Columns and Well Plates ... | 101-108 |
| 300 Å C4 Columns | 104 |
| Amino Columns and Well Plates | 106 |
| C18 Columns and Well Plates | 104 |
| Cyano Columns | 106 |
| Florisil (Pesticide Grade) Columns | 105 |
| Florisil Columns | 105 |
| LCC Columns | 106 |
| Mixed Mode (1) Columns and Well Plates | 105 |
| Mixed Mode (2) Columns | 105 |
| Mixed Mode (3) Columns | 105 |
| Phenyl Columns and Well Plates | 106 |
| Polyamine Columns | 106 |
| REC18 Columns and Well Plates | 104 |
| Silica Columns and Cartridges..... | 106 |
| Strong Anion Exchange Columns and Well Plates..... | 104 |
| Strong Cation Exchange Columns and Well Plates..... | 105 |
| Super-Poly Environmental Columns..... | 108 |
| Super-Poly Extra Wide Particle 1200 m ² /g Columns and Well Plates | 108 |
| Super-Poly Extreme Capacity 1500 m ² /g Columns and Well Plates | 108 |
| Super-Poly HLB Columns and Well Plates | 107 |
| Super-Poly Hydrophilic Columns..... | 108 |
| Super-Poly Lipophilic Columns | 108 |
| Weak Cation Exchange Columns and Well Plates..... | 105 |
| Solid Phase Extraction (SPE) Selection Kits..... | 109 |

Syringe Filters..... 100

| | |
|----------------------------------|-----|
| Nylon Filters | 100 |
| PTFE (Hydrophobic) Filters..... | 100 |
| PTFE (Hydrophilic) Filters | 100 |
| PVDF Filters | 100 |

Syringes 112

Vials, Caps and Septa..... 113-120

| | |
|--|---------|
| Autosampler Vials, Caps and Septa | 114-117 |
| 2 mL Vials (12 x 32 mm) | 114 |
| Caps and Septa | 116 |
| Inserts for 2 mL Vials..... | 115 |
| Kits - Convenience..... | 117 |
| Kits - Starter | 117 |
| Vials with fused inserts (12 x 32 mm)..... | 115 |
| Headspace Vials, Caps and Septa | |
| Caps and Septa | 119 |
| Kits - Convenience..... | 120 |
| Kits - Starter | 120 |
| Vials | 118 |

| | | | | | | | | | | | | | | | | | | | | | | | | | | | | | | | | | | | | | | | | | | | | | | | | | | | | | | | | | | | | | | | | | | | | | | | | | | | | | | | | | | | | | | | | | | | | | | | | | | | | | | | | | | | | | | | | | | | | | | | | | | | | | | | | | | | | | | | | | | | | | | | | | | | | | | | | | | | | | | | | | | | | | | | | | | | | | | | | | | | | | | | | | | | | | | | |
|--|-------------------|---|----------------|----------------|-----|-------------------------------------|------------|------------------|-----|----------------------|------------|------------------|-----|----------------------------|----------------|------------------|-----|-------------------|-----|----------------|-----|---------------|---------|----------------|-----|-----------------|-----|----------------|-----|----------------------------|---------|----------------|-----|----------------------------|---------|---------------|-----|--------------------|-----|-----------------|-----|-----------------|-----|--------------|-----|-----------------------------------|------------|--------------------|-----|------------------------|----------------|----------------|-----|--------------------|----------------|----------------|-----|--------------------------------|------------|--------------------|-----|--------------------------------|----------------|----------------|-----|--------------------------|----------------|-------------------|-----|-----------------------|------------|----------------|-----|--------------------|----------------|---------------------|-----|---|----------------|------------------|-----|-------------------------|-----|------------------|-----|----------------------------|-----|-------------------|-----|--------------------|-----|--|-----|-------------|-----|--|---------|---|------------|----------------|-----|--|--|-----------------|-----|--|--|------------------|-----|--|--|----------------|-----|--|--|--------------------------|-----|--|--|------------------------------|-----|--|--|-----------------|-----|--|--|------------------------------|-----|--|--|--------------------------|-----|--|--|----------------------------|-----|--|--|-----------------|-----|--|--|--------------------------|-----|--|--|------------------|-----|--|--|-----------------|-----|--|--|--------------------|-----|--|--|---------------|-----|--|--|---------------------|-----|--|--|------------------------|-----|--|--|----------------|-----|--|--|----------------|-----|--|--|-----------------------|-----|--|--|----------------|-----|--|--|----------------------------|-----|--|--|
| Autosampler Parts and Accessories..... | 228 | Detectors | 214-220 | | | | | | | | | | | | | | | | | | | | | | | | | | | | | | | | | | | | | | | | | | | | | | | | | | | | | | | | | | | | | | | | | | | | | | | | | | | | | | | | | | | | | | | | | | | | | | | | | | | | | | | | | | | | | | | | | | | | | | | | | | | | | | | | | | | | | | | | | | | | | | | | | | | | | | | | | | | | | | | | | | | | | | | | | | | | | | | | | | | | | | | | | | | | |
| Calibration Gas Blends - Arnel Analyzers..... | 199 | Electron Capture Detector (ECD)..... | 217 | | | | | | | | | | | | | | | | | | | | | | | | | | | | | | | | | | | | | | | | | | | | | | | | | | | | | | | | | | | | | | | | | | | | | | | | | | | | | | | | | | | | | | | | | | | | | | | | | | | | | | | | | | | | | | | | | | | | | | | | | | | | | | | | | | | | | | | | | | | | | | | | | | | | | | | | | | | | | | | | | | | | | | | | | | | | | | | | | | | | | | | | | | | | |
| Columns..... | 172-198 | Flame Ionization Detector (FID) | 214-215 | | | | | | | | | | | | | | | | | | | | | | | | | | | | | | | | | | | | | | | | | | | | | | | | | | | | | | | | | | | | | | | | | | | | | | | | | | | | | | | | | | | | | | | | | | | | | | | | | | | | | | | | | | | | | | | | | | | | | | | | | | | | | | | | | | | | | | | | | | | | | | | | | | | | | | | | | | | | | | | | | | | | | | | | | | | | | | | | | | | | | | | | | | | | |
| Capillary Columns - General Purpose..... | 176-188, 196, 198 | Flame Photometric Detector (FPD) | 216 | | | | | | | | | | | | | | | | | | | | | | | | | | | | | | | | | | | | | | | | | | | | | | | | | | | | | | | | | | | | | | | | | | | | | | | | | | | | | | | | | | | | | | | | | | | | | | | | | | | | | | | | | | | | | | | | | | | | | | | | | | | | | | | | | | | | | | | | | | | | | | | | | | | | | | | | | | | | | | | | | | | | | | | | | | | | | | | | | | | | | | | | | | | | |
| Arnel Replacement Columns..... | 198 | Nitrogen Phosphorous Detector (NPD) | 218 | | | | | | | | | | | | | | | | | | | | | | | | | | | | | | | | | | | | | | | | | | | | | | | | | | | | | | | | | | | | | | | | | | | | | | | | | | | | | | | | | | | | | | | | | | | | | | | | | | | | | | | | | | | | | | | | | | | | | | | | | | | | | | | | | | | | | | | | | | | | | | | | | | | | | | | | | | | | | | | | | | | | | | | | | | | | | | | | | | | | | | | | | | | | |
| Elite-1 | 176 | Photoionization Detector (PID)..... | 219 | | | | | | | | | | | | | | | | | | | | | | | | | | | | | | | | | | | | | | | | | | | | | | | | | | | | | | | | | | | | | | | | | | | | | | | | | | | | | | | | | | | | | | | | | | | | | | | | | | | | | | | | | | | | | | | | | | | | | | | | | | | | | | | | | | | | | | | | | | | | | | | | | | | | | | | | | | | | | | | | | | | | | | | | | | | | | | | | | | | | | | | | | | | | |
| Elite-1301 | 185 | Thermal Conductivity Detector (TCD)..... | 220 | Elite-17 | 180 | Ferrules and Connectors..... | 200 | Elite-1701 | 186 | Fittings..... | 201 | Elite-17MS | 181 | Gas Management..... | 229-243 | Elite-17MS+..... | 181 | Compressors | 240 | Elite-1HT..... | 177 | Filters | 229-233 | Elite-1MS..... | 177 | Flow Meter..... | 243 | Elite-200..... | 183 | Generators - Hydrogen..... | 234-237 | Elite-225..... | 184 | Generators - Zero Air..... | 238-239 | Elite-35..... | 182 | Leak Detector..... | 242 | Elite-35MS..... | 182 | Regulators..... | 241 | Elite-5..... | 178 | Injection Port Septum..... | 213 | Elite-5 Amine..... | 178 | Injectors | 204-209 | Elite-5HT..... | 178 | Liners..... | 210-211 | Elite-5MS..... | 179 | Marathon Filament | 221 | Elite-5MS II | 179 | Organic Standards | 244-245 | Elite-624..... | 189 | SMARTSource | 222-223 | Elite-624 MS..... | 189 | Syringes | 212 | Elite-WAX..... | 187 | Swafer..... | 202-203 | Elite-WAX ETR | 188 | Thermal Desorber Consumables and Accessories.... | 224-227 | Velocity-1 | 196 | Conditioning Oven | 226 | Velocity-5 | 196 | Kits and Accessories | 225 | Velocity-WAX..... | 196 | Packed Traps | 224 | Capillary Columns - Integrated Guard Columns | 173 | Tubes | 227 | Capillary Columns - Specialty Phases | 190-195 | Thermal Desorber Conditioning Oven | 226 | Elite-23 | 194 | | | Elite-2560..... | 194 | | | Elite-502.2..... | 193 | | | Elite-608..... | 193 | | | Elite-Alumina PLOT | 195 | | | Elite-Alumina/KCl PLOT | 195 | | | Elite-BAC | 190 | | | Elite-Betecyclodextrin | 193 | | | Elite-CLPesticides | 192 | | | Elite-Cyclosis B PLOT..... | 195 | | | Elite-FFAP..... | 194 | | | Elite-Molesive PLOT..... | 195 | | | Elite-MTBE | 194 | | | Elite-PONA..... | 194 | | | Elite-Q PLOT | 195 | | | Elite-RX..... | 193 | | | Elite-SimDist | 193 | | | Elite-SimDist HT | 194 | | | Elite-TPH..... | 194 | | | Elite-VMS..... | 191 | | | Elite-Volatiles | 192 | | | Elite-XLB..... | 191 | | | Custom Packed Columns..... | 197 | | |
| Elite-17 | 180 | Ferrules and Connectors..... | 200 | | | | | | | | | | | | | | | | | | | | | | | | | | | | | | | | | | | | | | | | | | | | | | | | | | | | | | | | | | | | | | | | | | | | | | | | | | | | | | | | | | | | | | | | | | | | | | | | | | | | | | | | | | | | | | | | | | | | | | | | | | | | | | | | | | | | | | | | | | | | | | | | | | | | | | | | | | | | | | | | | | | | | | | | | | | | | | | | | | | | | | | | | | | | |
| Elite-1701 | 186 | Fittings..... | 201 | | | | | | | | | | | | | | | | | | | | | | | | | | | | | | | | | | | | | | | | | | | | | | | | | | | | | | | | | | | | | | | | | | | | | | | | | | | | | | | | | | | | | | | | | | | | | | | | | | | | | | | | | | | | | | | | | | | | | | | | | | | | | | | | | | | | | | | | | | | | | | | | | | | | | | | | | | | | | | | | | | | | | | | | | | | | | | | | | | | | | | | | | | | | |
| Elite-17MS | 181 | Gas Management..... | 229-243 | | | | | | | | | | | | | | | | | | | | | | | | | | | | | | | | | | | | | | | | | | | | | | | | | | | | | | | | | | | | | | | | | | | | | | | | | | | | | | | | | | | | | | | | | | | | | | | | | | | | | | | | | | | | | | | | | | | | | | | | | | | | | | | | | | | | | | | | | | | | | | | | | | | | | | | | | | | | | | | | | | | | | | | | | | | | | | | | | | | | | | | | | | | | |
| Elite-17MS+..... | 181 | Compressors | 240 | | | | | | | | | | | | | | | | | | | | | | | | | | | | | | | | | | | | | | | | | | | | | | | | | | | | | | | | | | | | | | | | | | | | | | | | | | | | | | | | | | | | | | | | | | | | | | | | | | | | | | | | | | | | | | | | | | | | | | | | | | | | | | | | | | | | | | | | | | | | | | | | | | | | | | | | | | | | | | | | | | | | | | | | | | | | | | | | | | | | | | | | | | | | |
| Elite-1HT..... | 177 | Filters | 229-233 | | | | | | | | | | | | | | | | | | | | | | | | | | | | | | | | | | | | | | | | | | | | | | | | | | | | | | | | | | | | | | | | | | | | | | | | | | | | | | | | | | | | | | | | | | | | | | | | | | | | | | | | | | | | | | | | | | | | | | | | | | | | | | | | | | | | | | | | | | | | | | | | | | | | | | | | | | | | | | | | | | | | | | | | | | | | | | | | | | | | | | | | | | | | |
| Elite-1MS..... | 177 | Flow Meter..... | 243 | | | | | | | | | | | | | | | | | | | | | | | | | | | | | | | | | | | | | | | | | | | | | | | | | | | | | | | | | | | | | | | | | | | | | | | | | | | | | | | | | | | | | | | | | | | | | | | | | | | | | | | | | | | | | | | | | | | | | | | | | | | | | | | | | | | | | | | | | | | | | | | | | | | | | | | | | | | | | | | | | | | | | | | | | | | | | | | | | | | | | | | | | | | | |
| Elite-200..... | 183 | Generators - Hydrogen..... | 234-237 | | | | | | | | | | | | | | | | | | | | | | | | | | | | | | | | | | | | | | | | | | | | | | | | | | | | | | | | | | | | | | | | | | | | | | | | | | | | | | | | | | | | | | | | | | | | | | | | | | | | | | | | | | | | | | | | | | | | | | | | | | | | | | | | | | | | | | | | | | | | | | | | | | | | | | | | | | | | | | | | | | | | | | | | | | | | | | | | | | | | | | | | | | | | |
| Elite-225..... | 184 | Generators - Zero Air..... | 238-239 | | | | | | | | | | | | | | | | | | | | | | | | | | | | | | | | | | | | | | | | | | | | | | | | | | | | | | | | | | | | | | | | | | | | | | | | | | | | | | | | | | | | | | | | | | | | | | | | | | | | | | | | | | | | | | | | | | | | | | | | | | | | | | | | | | | | | | | | | | | | | | | | | | | | | | | | | | | | | | | | | | | | | | | | | | | | | | | | | | | | | | | | | | | | |
| Elite-35..... | 182 | Leak Detector..... | 242 | | | | | | | | | | | | | | | | | | | | | | | | | | | | | | | | | | | | | | | | | | | | | | | | | | | | | | | | | | | | | | | | | | | | | | | | | | | | | | | | | | | | | | | | | | | | | | | | | | | | | | | | | | | | | | | | | | | | | | | | | | | | | | | | | | | | | | | | | | | | | | | | | | | | | | | | | | | | | | | | | | | | | | | | | | | | | | | | | | | | | | | | | | | | |
| Elite-35MS..... | 182 | Regulators..... | 241 | | | | | | | | | | | | | | | | | | | | | | | | | | | | | | | | | | | | | | | | | | | | | | | | | | | | | | | | | | | | | | | | | | | | | | | | | | | | | | | | | | | | | | | | | | | | | | | | | | | | | | | | | | | | | | | | | | | | | | | | | | | | | | | | | | | | | | | | | | | | | | | | | | | | | | | | | | | | | | | | | | | | | | | | | | | | | | | | | | | | | | | | | | | | |
| Elite-5..... | 178 | Injection Port Septum..... | 213 | | | | | | | | | | | | | | | | | | | | | | | | | | | | | | | | | | | | | | | | | | | | | | | | | | | | | | | | | | | | | | | | | | | | | | | | | | | | | | | | | | | | | | | | | | | | | | | | | | | | | | | | | | | | | | | | | | | | | | | | | | | | | | | | | | | | | | | | | | | | | | | | | | | | | | | | | | | | | | | | | | | | | | | | | | | | | | | | | | | | | | | | | | | | |
| Elite-5 Amine..... | 178 | Injectors | 204-209 | | | | | | | | | | | | | | | | | | | | | | | | | | | | | | | | | | | | | | | | | | | | | | | | | | | | | | | | | | | | | | | | | | | | | | | | | | | | | | | | | | | | | | | | | | | | | | | | | | | | | | | | | | | | | | | | | | | | | | | | | | | | | | | | | | | | | | | | | | | | | | | | | | | | | | | | | | | | | | | | | | | | | | | | | | | | | | | | | | | | | | | | | | | | |
| Elite-5HT..... | 178 | Liners..... | 210-211 | | | | | | | | | | | | | | | | | | | | | | | | | | | | | | | | | | | | | | | | | | | | | | | | | | | | | | | | | | | | | | | | | | | | | | | | | | | | | | | | | | | | | | | | | | | | | | | | | | | | | | | | | | | | | | | | | | | | | | | | | | | | | | | | | | | | | | | | | | | | | | | | | | | | | | | | | | | | | | | | | | | | | | | | | | | | | | | | | | | | | | | | | | | | |
| Elite-5MS..... | 179 | Marathon Filament | 221 | | | | | | | | | | | | | | | | | | | | | | | | | | | | | | | | | | | | | | | | | | | | | | | | | | | | | | | | | | | | | | | | | | | | | | | | | | | | | | | | | | | | | | | | | | | | | | | | | | | | | | | | | | | | | | | | | | | | | | | | | | | | | | | | | | | | | | | | | | | | | | | | | | | | | | | | | | | | | | | | | | | | | | | | | | | | | | | | | | | | | | | | | | | | |
| Elite-5MS II | 179 | Organic Standards | 244-245 | | | | | | | | | | | | | | | | | | | | | | | | | | | | | | | | | | | | | | | | | | | | | | | | | | | | | | | | | | | | | | | | | | | | | | | | | | | | | | | | | | | | | | | | | | | | | | | | | | | | | | | | | | | | | | | | | | | | | | | | | | | | | | | | | | | | | | | | | | | | | | | | | | | | | | | | | | | | | | | | | | | | | | | | | | | | | | | | | | | | | | | | | | | | |
| Elite-624..... | 189 | SMARTSource | 222-223 | | | | | | | | | | | | | | | | | | | | | | | | | | | | | | | | | | | | | | | | | | | | | | | | | | | | | | | | | | | | | | | | | | | | | | | | | | | | | | | | | | | | | | | | | | | | | | | | | | | | | | | | | | | | | | | | | | | | | | | | | | | | | | | | | | | | | | | | | | | | | | | | | | | | | | | | | | | | | | | | | | | | | | | | | | | | | | | | | | | | | | | | | | | | |
| Elite-624 MS..... | 189 | Syringes | 212 | | | | | | | | | | | | | | | | | | | | | | | | | | | | | | | | | | | | | | | | | | | | | | | | | | | | | | | | | | | | | | | | | | | | | | | | | | | | | | | | | | | | | | | | | | | | | | | | | | | | | | | | | | | | | | | | | | | | | | | | | | | | | | | | | | | | | | | | | | | | | | | | | | | | | | | | | | | | | | | | | | | | | | | | | | | | | | | | | | | | | | | | | | | | |
| Elite-WAX..... | 187 | Swafer..... | 202-203 | | | | | | | | | | | | | | | | | | | | | | | | | | | | | | | | | | | | | | | | | | | | | | | | | | | | | | | | | | | | | | | | | | | | | | | | | | | | | | | | | | | | | | | | | | | | | | | | | | | | | | | | | | | | | | | | | | | | | | | | | | | | | | | | | | | | | | | | | | | | | | | | | | | | | | | | | | | | | | | | | | | | | | | | | | | | | | | | | | | | | | | | | | | | |
| Elite-WAX ETR | 188 | Thermal Desorber Consumables and Accessories.... | 224-227 | | | | | | | | | | | | | | | | | | | | | | | | | | | | | | | | | | | | | | | | | | | | | | | | | | | | | | | | | | | | | | | | | | | | | | | | | | | | | | | | | | | | | | | | | | | | | | | | | | | | | | | | | | | | | | | | | | | | | | | | | | | | | | | | | | | | | | | | | | | | | | | | | | | | | | | | | | | | | | | | | | | | | | | | | | | | | | | | | | | | | | | | | | | | |
| Velocity-1 | 196 | Conditioning Oven | 226 | | | | | | | | | | | | | | | | | | | | | | | | | | | | | | | | | | | | | | | | | | | | | | | | | | | | | | | | | | | | | | | | | | | | | | | | | | | | | | | | | | | | | | | | | | | | | | | | | | | | | | | | | | | | | | | | | | | | | | | | | | | | | | | | | | | | | | | | | | | | | | | | | | | | | | | | | | | | | | | | | | | | | | | | | | | | | | | | | | | | | | | | | | | | |
| Velocity-5 | 196 | Kits and Accessories | 225 | | | | | | | | | | | | | | | | | | | | | | | | | | | | | | | | | | | | | | | | | | | | | | | | | | | | | | | | | | | | | | | | | | | | | | | | | | | | | | | | | | | | | | | | | | | | | | | | | | | | | | | | | | | | | | | | | | | | | | | | | | | | | | | | | | | | | | | | | | | | | | | | | | | | | | | | | | | | | | | | | | | | | | | | | | | | | | | | | | | | | | | | | | | | |
| Velocity-WAX..... | 196 | Packed Traps | 224 | | | | | | | | | | | | | | | | | | | | | | | | | | | | | | | | | | | | | | | | | | | | | | | | | | | | | | | | | | | | | | | | | | | | | | | | | | | | | | | | | | | | | | | | | | | | | | | | | | | | | | | | | | | | | | | | | | | | | | | | | | | | | | | | | | | | | | | | | | | | | | | | | | | | | | | | | | | | | | | | | | | | | | | | | | | | | | | | | | | | | | | | | | | | |
| Capillary Columns - Integrated Guard Columns | 173 | Tubes | 227 | | | | | | | | | | | | | | | | | | | | | | | | | | | | | | | | | | | | | | | | | | | | | | | | | | | | | | | | | | | | | | | | | | | | | | | | | | | | | | | | | | | | | | | | | | | | | | | | | | | | | | | | | | | | | | | | | | | | | | | | | | | | | | | | | | | | | | | | | | | | | | | | | | | | | | | | | | | | | | | | | | | | | | | | | | | | | | | | | | | | | | | | | | | | |
| Capillary Columns - Specialty Phases | 190-195 | Thermal Desorber Conditioning Oven | 226 | | | | | | | | | | | | | | | | | | | | | | | | | | | | | | | | | | | | | | | | | | | | | | | | | | | | | | | | | | | | | | | | | | | | | | | | | | | | | | | | | | | | | | | | | | | | | | | | | | | | | | | | | | | | | | | | | | | | | | | | | | | | | | | | | | | | | | | | | | | | | | | | | | | | | | | | | | | | | | | | | | | | | | | | | | | | | | | | | | | | | | | | | | | | |
| Elite-23 | 194 | | | | | | | | | | | | | | | | | | | | | | | | | | | | | | | | | | | | | | | | | | | | | | | | | | | | | | | | | | | | | | | | | | | | | | | | | | | | | | | | | | | | | | | | | | | | | | | | | | | | | | | | | | | | | | | | | | | | | | | | | | | | | | | | | | | | | | | | | | | | | | | | | | | | | | | | | | | | | | | | | | | | | | | | | | | | | | | | | | | | | | | | | | | | | | |
| Elite-2560..... | 194 | | | | | | | | | | | | | | | | | | | | | | | | | | | | | | | | | | | | | | | | | | | | | | | | | | | | | | | | | | | | | | | | | | | | | | | | | | | | | | | | | | | | | | | | | | | | | | | | | | | | | | | | | | | | | | | | | | | | | | | | | | | | | | | | | | | | | | | | | | | | | | | | | | | | | | | | | | | | | | | | | | | | | | | | | | | | | | | | | | | | | | | | | | | | | | |
| Elite-502.2..... | 193 | | | | | | | | | | | | | | | | | | | | | | | | | | | | | | | | | | | | | | | | | | | | | | | | | | | | | | | | | | | | | | | | | | | | | | | | | | | | | | | | | | | | | | | | | | | | | | | | | | | | | | | | | | | | | | | | | | | | | | | | | | | | | | | | | | | | | | | | | | | | | | | | | | | | | | | | | | | | | | | | | | | | | | | | | | | | | | | | | | | | | | | | | | | | | | |
| Elite-608..... | 193 | | | | | | | | | | | | | | | | | | | | | | | | | | | | | | | | | | | | | | | | | | | | | | | | | | | | | | | | | | | | | | | | | | | | | | | | | | | | | | | | | | | | | | | | | | | | | | | | | | | | | | | | | | | | | | | | | | | | | | | | | | | | | | | | | | | | | | | | | | | | | | | | | | | | | | | | | | | | | | | | | | | | | | | | | | | | | | | | | | | | | | | | | | | | | | |
| Elite-Alumina PLOT | 195 | | | | | | | | | | | | | | | | | | | | | | | | | | | | | | | | | | | | | | | | | | | | | | | | | | | | | | | | | | | | | | | | | | | | | | | | | | | | | | | | | | | | | | | | | | | | | | | | | | | | | | | | | | | | | | | | | | | | | | | | | | | | | | | | | | | | | | | | | | | | | | | | | | | | | | | | | | | | | | | | | | | | | | | | | | | | | | | | | | | | | | | | | | | | | | |
| Elite-Alumina/KCl PLOT | 195 | | | | | | | | | | | | | | | | | | | | | | | | | | | | | | | | | | | | | | | | | | | | | | | | | | | | | | | | | | | | | | | | | | | | | | | | | | | | | | | | | | | | | | | | | | | | | | | | | | | | | | | | | | | | | | | | | | | | | | | | | | | | | | | | | | | | | | | | | | | | | | | | | | | | | | | | | | | | | | | | | | | | | | | | | | | | | | | | | | | | | | | | | | | | | | |
| Elite-BAC | 190 | | | | | | | | | | | | | | | | | | | | | | | | | | | | | | | | | | | | | | | | | | | | | | | | | | | | | | | | | | | | | | | | | | | | | | | | | | | | | | | | | | | | | | | | | | | | | | | | | | | | | | | | | | | | | | | | | | | | | | | | | | | | | | | | | | | | | | | | | | | | | | | | | | | | | | | | | | | | | | | | | | | | | | | | | | | | | | | | | | | | | | | | | | | | | | |
| Elite-Betecyclodextrin | 193 | | | | | | | | | | | | | | | | | | | | | | | | | | | | | | | | | | | | | | | | | | | | | | | | | | | | | | | | | | | | | | | | | | | | | | | | | | | | | | | | | | | | | | | | | | | | | | | | | | | | | | | | | | | | | | | | | | | | | | | | | | | | | | | | | | | | | | | | | | | | | | | | | | | | | | | | | | | | | | | | | | | | | | | | | | | | | | | | | | | | | | | | | | | | | | |
| Elite-CLPesticides | 192 | | | | | | | | | | | | | | | | | | | | | | | | | | | | | | | | | | | | | | | | | | | | | | | | | | | | | | | | | | | | | | | | | | | | | | | | | | | | | | | | | | | | | | | | | | | | | | | | | | | | | | | | | | | | | | | | | | | | | | | | | | | | | | | | | | | | | | | | | | | | | | | | | | | | | | | | | | | | | | | | | | | | | | | | | | | | | | | | | | | | | | | | | | | | | | |
| Elite-Cyclosis B PLOT..... | 195 | | | | | | | | | | | | | | | | | | | | | | | | | | | | | | | | | | | | | | | | | | | | | | | | | | | | | | | | | | | | | | | | | | | | | | | | | | | | | | | | | | | | | | | | | | | | | | | | | | | | | | | | | | | | | | | | | | | | | | | | | | | | | | | | | | | | | | | | | | | | | | | | | | | | | | | | | | | | | | | | | | | | | | | | | | | | | | | | | | | | | | | | | | | | | | |
| Elite-FFAP..... | 194 | | | | | | | | | | | | | | | | | | | | | | | | | | | | | | | | | | | | | | | | | | | | | | | | | | | | | | | | | | | | | | | | | | | | | | | | | | | | | | | | | | | | | | | | | | | | | | | | | | | | | | | | | | | | | | | | | | | | | | | | | | | | | | | | | | | | | | | | | | | | | | | | | | | | | | | | | | | | | | | | | | | | | | | | | | | | | | | | | | | | | | | | | | | | | | |
| Elite-Molesive PLOT..... | 195 | | | | | | | | | | | | | | | | | | | | | | | | | | | | | | | | | | | | | | | | | | | | | | | | | | | | | | | | | | | | | | | | | | | | | | | | | | | | | | | | | | | | | | | | | | | | | | | | | | | | | | | | | | | | | | | | | | | | | | | | | | | | | | | | | | | | | | | | | | | | | | | | | | | | | | | | | | | | | | | | | | | | | | | | | | | | | | | | | | | | | | | | | | | | | | |
| Elite-MTBE | 194 | | | | | | | | | | | | | | | | | | | | | | | | | | | | | | | | | | | | | | | | | | | | | | | | | | | | | | | | | | | | | | | | | | | | | | | | | | | | | | | | | | | | | | | | | | | | | | | | | | | | | | | | | | | | | | | | | | | | | | | | | | | | | | | | | | | | | | | | | | | | | | | | | | | | | | | | | | | | | | | | | | | | | | | | | | | | | | | | | | | | | | | | | | | | | | |
| Elite-PONA..... | 194 | | | | | | | | | | | | | | | | | | | | | | | | | | | | | | | | | | | | | | | | | | | | | | | | | | | | | | | | | | | | | | | | | | | | | | | | | | | | | | | | | | | | | | | | | | | | | | | | | | | | | | | | | | | | | | | | | | | | | | | | | | | | | | | | | | | | | | | | | | | | | | | | | | | | | | | | | | | | | | | | | | | | | | | | | | | | | | | | | | | | | | | | | | | | | | |
| Elite-Q PLOT | 195 | | | | | | | | | | | | | | | | | | | | | | | | | | | | | | | | | | | | | | | | | | | | | | | | | | | | | | | | | | | | | | | | | | | | | | | | | | | | | | | | | | | | | | | | | | | | | | | | | | | | | | | | | | | | | | | | | | | | | | | | | | | | | | | | | | | | | | | | | | | | | | | | | | | | | | | | | | | | | | | | | | | | | | | | | | | | | | | | | | | | | | | | | | | | | | |
| Elite-RX..... | 193 | | | | | | | | | | | | | | | | | | | | | | | | | | | | | | | | | | | | | | | | | | | | | | | | | | | | | | | | | | | | | | | | | | | | | | | | | | | | | | | | | | | | | | | | | | | | | | | | | | | | | | | | | | | | | | | | | | | | | | | | | | | | | | | | | | | | | | | | | | | | | | | | | | | | | | | | | | | | | | | | | | | | | | | | | | | | | | | | | | | | | | | | | | | | | | |
| Elite-SimDist | 193 | | | | | | | | | | | | | | | | | | | | | | | | | | | | | | | | | | | | | | | | | | | | | | | | | | | | | | | | | | | | | | | | | | | | | | | | | | | | | | | | | | | | | | | | | | | | | | | | | | | | | | | | | | | | | | | | | | | | | | | | | | | | | | | | | | | | | | | | | | | | | | | | | | | | | | | | | | | | | | | | | | | | | | | | | | | | | | | | | | | | | | | | | | | | | | |
| Elite-SimDist HT | 194 | | | | | | | | | | | | | | | | | | | | | | | | | | | | | | | | | | | | | | | | | | | | | | | | | | | | | | | | | | | | | | | | | | | | | | | | | | | | | | | | | | | | | | | | | | | | | | | | | | | | | | | | | | | | | | | | | | | | | | | | | | | | | | | | | | | | | | | | | | | | | | | | | | | | | | | | | | | | | | | | | | | | | | | | | | | | | | | | | | | | | | | | | | | | | | |
| Elite-TPH..... | 194 | | | | | | | | | | | | | | | | | | | | | | | | | | | | | | | | | | | | | | | | | | | | | | | | | | | | | | | | | | | | | | | | | | | | | | | | | | | | | | | | | | | | | | | | | | | | | | | | | | | | | | | | | | | | | | | | | | | | | | | | | | | | | | | | | | | | | | | | | | | | | | | | | | | | | | | | | | | | | | | | | | | | | | | | | | | | | | | | | | | | | | | | | | | | | | |
| Elite-VMS..... | 191 | | | | | | | | | | | | | | | | | | | | | | | | | | | | | | | | | | | | | | | | | | | | | | | | | | | | | | | | | | | | | | | | | | | | | | | | | | | | | | | | | | | | | | | | | | | | | | | | | | | | | | | | | | | | | | | | | | | | | | | | | | | | | | | | | | | | | | | | | | | | | | | | | | | | | | | | | | | | | | | | | | | | | | | | | | | | | | | | | | | | | | | | | | | | | | |
| Elite-Volatiles | 192 | | | | | | | | | | | | | | | | | | | | | | | | | | | | | | | | | | | | | | | | | | | | | | | | | | | | | | | | | | | | | | | | | | | | | | | | | | | | | | | | | | | | | | | | | | | | | | | | | | | | | | | | | | | | | | | | | | | | | | | | | | | | | | | | | | | | | | | | | | | | | | | | | | | | | | | | | | | | | | | | | | | | | | | | | | | | | | | | | | | | | | | | | | | | | | |
| Elite-XLB..... | 191 | | | | | | | | | | | | | | | | | | | | | | | | | | | | | | | | | | | | | | | | | | | | | | | | | | | | | | | | | | | | | | | | | | | | | | | | | | | | | | | | | | | | | | | | | | | | | | | | | | | | | | | | | | | | | | | | | | | | | | | | | | | | | | | | | | | | | | | | | | | | | | | | | | | | | | | | | | | | | | | | | | | | | | | | | | | | | | | | | | | | | | | | | | | | | | |
| Custom Packed Columns..... | 197 | | | | | | | | | | | | | | | | | | | | | | | | | | | | | | | | | | | | | | | | | | | | | | | | | | | | | | | | | | | | | | | | | | | | | | | | | | | | | | | | | | | | | | | | | | | | | | | | | | | | | | | | | | | | | | | | | | | | | | | | | | | | | | | | | | | | | | | | | | | | | | | | | | | | | | | | | | | | | | | | | | | | | | | | | | | | | | | | | | | | | | | | | | | | | | |

| | |
|---|--------------|
| Cones | 57 |
| Cone Removal Tool..... | 57 |
| Hyper Skimmer Cone and Spares..... | 57 |
| Sampler and Skimmer Cone O-Rings | 57 |
| Injectors and Adapters | 54-55 |
| Injector Support Adapter O-Rings..... | 54-55 |
| Injector Support Adapters..... | 54-55 |
| Injectors | |
| Alumina Injectors..... | 54 |
| Quartz Injectors | 54 |
| Sapphire Injectors | 54 |
| PFA Injector Assemblies | 54 |
| Mass Spectrometer Hardware | 56 |
| Detectors | 56 |
| Ion Optics..... | 56 |
| Ion Lens..... | 56 |
| ShadowStop..... | 56 |
| Vacuum Pump Fluid..... | 56 |
| Nebulizers and Supplies | 48-50 |
| Adapters and Fittings | 48-49 |
| End Cap for Concentric Nebulizers | 48 |
| Liquid Connector..... | 48 |
| Nebulizers | 48-50 |
| GemClean Cross-Flow II Nebulizer | 48 |
| Meinhard Nebulizers and Spares | 48 |
| MicroMist Nebulizers | 49 |
| Obstruction Removal Tool | 49-50 |
| PFA Nebulizers | 38 |
| SeaSpray Nebulizers..... | 50 |
| Sample Introduction Kits | 58-59 |
| Sample Capillaries | 50 |
| Connectors and Spares..... | 48 |
| Sample Introduction Kits and Spares Kits..... | 58-59 |
| ELAN Spares Kits | 58 |
| NexION Consumables Kits | 59 |
| Sample Introduction Systems for ELAN | 58 |
| Spray Chambers | 51-53 |
| Baffled Cyclonic Spray Chambers | 51 |
| Cyclonic Spray Chambers | 51-52 |
| Scott Spray Chambers | 52 |
| Temperature Controlled Spray Chambers..... | 53 |
| IsoMist Programmable Temperature Spray Chambers | 53 |
| PC ³ Peltier Coolers | 53 |
| Torches and Load Coil..... | 55 |
| Cassette Torch Mount | 55 |
| Demountable Quartz Torches | 55 |
| Power Amplifier Tube (Ceramic)..... | 55 |
| RF Load Coil Assemblies | 55 |
| Torch Alignment Tool..... | 55 |

| | |
|--|------------------|
| Air Compressors and Replacement Parts | 46 |
| Compressors | 46 |
| Replacement Parts | 46 |
| Benches and Carts | 47 |
| Injectors and Adapters | 44 |
| Alumina Injectors | 44 |
| FAST Injectors | 44 |
| Injector Support Adapter O-Ring Kits | 44 |
| Injector Support Adapters | 44 |
| Quartz Injectors | 44 |
| Sapphire Injectors | 44 |
| Load Coils and Purge Windows | 45 |
| Ceramic Interface Cone | 45 |
| Ceramic Purge Extension | 45 |
| Purge Component Replacement Parts | 45 |
| Purge Extension Windows | 45 |
| RF Load Coil | 45 |
| Nebulizers and Supplies | 34-37 |
| Argon Humidifier | 37 |
| Nebulizers | 34-37 |
| End Cap for Concentric Nebulizers | 34 |
| GemCone High Dissolved Solids Nebulizer | 37 |
| GemCone Low-Flow Nebulizers | 37 |
| GemTip Cross-Flow II Nebulizers | 37 |
| Meinhard Nebulizers | 34 |
| MicroMist Nebulizers | 34 |
| Mira Mist Nebulizer | 34 |
| PFA Nebulizers | 36 |
| Sample Capillaries | 36 |
| Sample Tube Connectors | 36 |
| Seaspray Nebulizers | 35 |
| Obstruction Removal Tool | 36 |
| Sample Introduction Kits | 41 |
| Spray Chambers and Accessories | 38-39 |
| Accessories and Drain Parts | 38 |
| Baffled Cyclonic Spray Chambers | 39 |
| Connectors and Spares | 38 |
| Cyclonic Spray Chambers | 38 |
| HF Resistant Spray Chambers | 39 |
| Scott Spray Chambers | 39 |
| Torches, Modules and Hardware | 40, 42-43 |
| Torches and Torch Accessories | 42-43 |
| Ceramic D-Torch | 43 |
| Copper Ignitor Tape | 42 |
| Quartz Torches | 42-43 |
| Torch Bonnets | 42 |
| Torch O-Rings | 42 |
| Quick-Change Torch Modules | 40 |
| Quick-Change Torch Module Support Stand | 40 |

| | | | |
|--|----------------|--|----------------|
| Accessories Overview | 248-249 | Imaging Accessories..... | 264 |
| Application Packs..... | 266 | ATR Imaging Upgrade for Spotlight Systems | 264 |
| Benzene in Gasoline ASTM D4053-04 | 266 | Crystal Compression Cell | 264 |
| Biodiesel..... | 266 | Diamond Compression Cell | 264 |
| Educational | 266 | Hot Stage Accessory..... | 264 |
| Environmental Hydrocarbons ASTM D7066-04 | 266 | Infrared Windows..... | 264 |
| Environmental Hydrocarbons ATR..... | 266 | Micro ATR Objective Upgrade Kit..... | 264 |
| Environmental Hydrocarbons Cyclohexane..... | 266 | Microsampling Tools..... | 264 |
| In-Service Lubricants..... | 266 | Microscope Supplies..... | 264 |
| Neutraceutical Compliance..... | 266 | OilExpress Supplies..... | 262 |
| Pharmacopeia Compliance | 266 | OilExpress Supplies | 262 |
| Polymer..... | 266 | Spare Parts | 262 |
| ATR Accessories..... | 250-251 | Tubes and Bottles | 262 |
| PerkinElmer ATR Accessories..... | 250 | Tubing..... | 262 |
| HATR | 250 | Presses and Accessories..... | 261 |
| UATR | 250 | Evacuatable KBr Mini-press..... | 261 |
| Pike ATR Accessories | 250-251 | Hydraulic KBr Presses..... | 261 |
| ATR Miracle | 250 | KBr Pellet Quick Press | 261 |
| GladiATR Vision | 251 | KBr Powder..... | 261 |
| Variable Angle ATR (VATR) | 251 | Support Rings for KBr Pellets | 261 |
| Multiple (10) Reflection HATR | 250 | Sampling and Starter Kits | 265 |
| Specac ATR Accessories..... | 250-251 | Spectrum Two Portability Options..... | 262 |
| 25 Reflection ATR | 251 | Specular Reflectance Accessories..... | 255 |
| Gateway HATR | 251 | PerkinElmer Accessories..... | 255 |
| Golden Gate ATR..... | 251 | Pike Accessories | 255 |
| ATR Top Plate Accessories | 252-253 | Pike Specular Reflectance Options | 255 |
| PerkinElmer ATR Top Plates & Options | 252 | Transmission Accessories and Options..... | 256-260 |
| Pike ATR Top Plates & Options | 253 | Accessories | |
| Silver Gate Evolution ATR | 253 | Circular Demountable Cell Windows (Pair) | 257 |
| Specac ATR Top Plates & Options..... | 253 | Circular Spacers..... | 257 |
| Desiccant and Laser Kits, Sources and | | Crystal Polishing Kit and Replacement Parts | 256 |
| Reference Materials | 263 | DC-2 Diamond Compression Cell..... | 259 |
| Disposable Desiccant Kit..... | 263 | Demountable Cells and Windows | 257 |
| Instrument Performance Validation (IPV) Kits | 263 | FT-NIR Liquid Cells and Holders | 258 |
| Rechargeable Desiccant Kits | 263 | Press-N-Lock Demountable Cell and Windows | 258 |
| Replacement Laser Head Kit and Sources..... | 263 | Press-N-Lock Demountable Cell Windows (Pair) | 258 |
| Diffuse Reflectance Accessories and Options | 254-255 | Rectangular Sealed Liquid Cells..... | 258 |
| PerkinElmer Accessories..... | 254 | Rectangular Semi-Demountable Cell Windows..... | 257 |
| Pike Accessories | 254 | Rectangular Spacers..... | 257 |
| Specac Accessories..... | 254 | Sealed Liquid Cells..... | 258 |
| Diffuse Reflectance Options..... | 254 | Semi-Demountable Cells and Windows | 257 |
| PerkinElmer | 254 | Short Path Demountable Gas Cells..... | 259 |
| Pike | 254 | The Cyclone Series of Fixed and Variable Long | |
| FT-NIR Consumables and Accessories | 267 | Pathlength Gas Cells | 259 |
| General Consumables | 267 | The Gasera Photoacoustic PA301 FTIR Accessory..... | 260 |
| Reflectance Standards | 267 | The Oxford Instrument Optistat DN..... | 260 |
| Sample Cups..... | 267 | The Storm Short Pathlength (10 cm) Gas Cell..... | 260 |
| Spare Parts..... | 267 | The Tornado Series of Fixed, Long Pathlength Gas Cells | 259 |
| | | Variable Temperature Cell | 259 |
| | | Transmission Options..... | 260 |

| | |
|---|-----------------|
| Columns | 124-153 |
| Cartridge Columns | 144-153 |
| Brownlee Aquapore | 145 |
| Brownlee CHOICE | 150 |
| Brownlee Pecoshpere | 147 |
| Brownlee Polypore | 149 |
| Brownlee Prep-10 Semi-Preparative | 149 |
| Brownlee Spheri-10..... | 146 |
| Brownlee Spheri-5..... | 146 |
| Brownlee Validated | 148 |
| Brownlee VeloSep | 151 |
| Column Holders | 153 |
| NewGuard | 152 |
| Conventional Columns | 127-143 |
| Brownlee Analytical | 129-131 |
| Brownlee Analytical DB | 132-134 |
| Brownlee Aquapore | 135 |
| Brownlee Bio | 135 |
| Brownlee CHOICE | 136-137 |
| Brownlee Validated | 138-141 |
| Guard Columns..... | 142-143 |
| SPP Columns | 124-126 |
| Detector Lamps | 155 |
| Fingertight Fittings | 162 |
| Flexar Autosampler and Accessories | 164-165 |
| Flexar SQ 300 MS Consumables and Accessories | 122 -123 |
| Flow Cells | 154 |
| General Supplies and Accessories | 166-168 |
| Generators - Nitrogen | 169-171 |
| Injection Valves | 163 |
| Pumps | 158-160 |
| Pump Accessory Kits | 154 |
| Rotor Seals | 163 |
| Sample Loops | 161 |
| Tubing | 161 |
| Vacuum Degassing Kits | 156-157 |

DMA Supplies..... 296-297

| | |
|---|-----|
| Calibration Supplies..... | 296 |
| Replaceable Parts | 296 |
| Cooling Accessories..... | 297 |
| Specialty Fixtures and Accessories..... | 297 |

DSC Supplies..... 290-292

| | |
|---------------------------------------|---------|
| Calibration Reference Materials | 292 |
| Crimpers and Presses..... | 290-291 |
| Loading Tools | 292 |
| Sample Holder Supplies..... | 292 |
| Sample Pan Manipulators..... | 292 |
| Sample Pans and Covers..... | 290 |

Elemental Analysis Supplies..... 298-299

| | |
|----------------------------------|-----|
| Calibration Standards | 298 |
| Packing Supplies..... | 298 |
| Reagents | 298 |
| Receptacles | 298 |
| Sample Capsules and Sealers..... | 299 |
| Tubes | 299 |
| Tubes - Prepacked | 298 |
| Tubes and Reagent Kits | 298 |

TGA/STA Supplies 294-295

| | |
|---|-----|
| Autosampler Ceramic Crucible Kits and Liners..... | 295 |
| Calibration Reference Materials | 295 |
| Cooling Jacket..... | 295 |
| Forceps | 295 |
| Furnace and Balance Supplies..... | 294 |
| Pans | 295 |
| Replacement Needle Kit | 295 |
| Volatile Capsule Sealer Kit | 295 |

TMA Supplies 293

| | |
|-------------------------------|-----|
| Analysis Kits | 293 |
| Probes and Sample Tools | 293 |
| Reference Materials..... | 293 |
| Spares | 293 |

| | | | |
|--|----------------|--|----------------|
| Cells..... | 270-274 | Integrating Spheres | 280 |
| Cylindrical and Flow-Through Cells..... | 273 | 150 mm Integrating Spheres | 280 |
| Disposable Cells | 274 | 50 mm Integrating Sphere | 280 |
| Macro Cells..... | 270 | Cell Holder..... | 280 |
| Micro Cells..... | 271 | Center Mounted Sample Holder..... | 280 |
| Semi-Micro Cells | 271 | Lamps..... | 268 |
| Ultra-Micro Cells | 272 | Deuterium..... | 268 |
| Cell Changers..... | 276 | Tungsten | 268 |
| 5+5 Cell Changer..... | 276 | Polarimetry Cells and Accessories..... | 283 |
| 8+1 Cell Changer..... | 276 | Beaker Cells | 283 |
| 8+8 Cell Changer..... | 276 | Flow Cells..... | 283 |
| 13 Cell Changer..... | 276 | Interference Filter | 283 |
| Automatic Linear Transport..... | 276 | Micro Cells..... | 283 |
| Gel Cell, Glass..... | 276 | Pluggable Coupling..... | 283 |
| Reference Kit..... | 276 | PTFE Stopper..... | 283 |
| Cell Holders | 275 | Quartz Standards | 283 |
| Cylindrical Long-Path Cell Holder..... | 275 | Short Path Cells..... | 283 |
| Rectangular Long-Path Cell Holder | 275 | Source Lamps..... | 283 |
| Solid Sample Holder | 275 | Standard Cells | 283 |
| Standard Cell Holder | 275 | Standards..... | 283 |
| Test Tube Holder..... | 275 | Polarizers and Depolarizers..... | 281 |
| Variable Angle Sample Holder | 275 | Reference Materials | 268-269 |
| Fiber-Optics Accessories | 282 | Calibration Reference Materials..... | 268 |
| Fiber Optic Dip Probe | 282 | Diffuse Reflectance Standards..... | 269 |
| Light Shield | 282 | Pharmacopoeia Solutions Reference Material Set..... | 269 |
| Pair of Mono-Fibers | 282 | Photometric and Wavelength Accuracy Reference | |
| Probe Tip..... | 282 | Material Set..... | 269 |
| Transfer-Optic for Mono-Fibers..... | 282 | Recertification Program for UV/Vis Calibration | |
| General Purpose Optical Bench Kits | 282 | Reference Materials | 269 |
| Sample Holder Mount Kit..... | 282 | Reference Mirror for Reflectance Spectroscopy | 269 |
| Variable Angle Transmittance Sample Holder Kit..... | 282 | Stray Light Solutions Reference Material Set | 269 |
| Optical Bench Kit..... | 282 | Specular Reflectance Accessories..... | 279 |
| Short Focal Length Mirror Kit, Spot Incidence | 282 | Relative Specular Reflectance Accessories | 279 |
| Beam Blocker Kit..... | 282 | Universal Reflectance Accessory (URA)..... | 279 |
| Fiber Optic Measurement Stage and Holder Kit | 282 | Variable-Angle Relative Specular Reflectance Accessory | 279 |
| Fluorescence Consumables and Accessories | 284-289 | Sipper..... | 281 |
| Cells..... | 284-285 | Thermostatting Accessories | 277-278 |
| Lamps | 286 | Research Peltier Systems..... | 278 |
| Fluorescence Thermostatting Accessories..... | 287 | Routine Peltier Systems..... | 277 |
| Biokinetics Accessory | 287 | | |
| Four-Position Thermostatted Automatic Cell Changer | 287 | | |
| Luminescence Accessory | 287 | | |
| Sample Tubes | 287 | | |
| Single-Cell Peltier Accessory..... | 287 | | |
| Single-Position Thermostatted Cell Holder..... | 287 | | |
| Reference Materials..... | 286 | | |
| Sampling Accessories | 288-289 | | |
| Front-Surface Accessory..... | 289 | | |
| LC Flow Cell Accessory | 288 | | |
| Liquid Sipper Accessory..... | 288 | | |
| Remote Fiber-Optic Accessory..... | 289 | | |
| Total Emission Accessory..... | 289 | | |
| Well-Plate Reader Accessory | 288 | | |

PerkinElmer, Inc.
940 Winter Street
Waltham, MA 02451 USA
P: (800) 762-4000 or
(+1) 203-925-4602
www.perkinelmer.com



For a complete listing of our global offices, visit www.perkinelmer.com/ContactUs

Copyright ©2014, PerkinElmer, Inc. All rights reserved. PerkinElmer is a trademark of PerkinElmer, Inc. All other trademarks are the property of their respective owners.

011640_02